

# QC 5200 Series

## Video Edge Detection Systems

### User's Guide



# ***QC5200 Series*** **User's Guide**

**Video Edge Detection Systems**  
**QC5200, QC5210, QC5230 and QC5240**

Metronics, Inc.  
30 Harvey Road  
Bedford, New Hampshire 03110  
Telephone (603) 622.0212  
Facsimile (603) 623.5623  
[sales@metronics.com](mailto:sales@metronics.com)  
[www.metronics.com](http://www.metronics.com)



## **QC5200 Series User's Guide**

### **Video edge detection systems: QC5200, QC5210, QC5230, and QC5240**

Published by  
Metronics, Inc.  
30 Harvey Road  
Bedford, New Hampshire 03110  
www.Metronics.com

Copyright © 2005 by Metronics, Inc., Bedford, New Hampshire

Printed in the United States of America

All information set forth in this document, all rights to such information, any and all inventions disclosed herein and any patents that might be granted by employing the materials, methods, techniques or apparatus described herein are the exclusive property of Metronics Inc., Bedford, New Hampshire.

Terms, conditions and features referenced in this document are subject to change without notice

No part of this document may be reproduced, stored in a retrieval system, or transmitted in any form or by any means, electronic, mechanical, photocopying, recording, or otherwise, without prior written permission of Metronics, Inc.. Requests to Metronics, Inc. for permission should be addressed to the Technical Services Department, Metronics, Inc., 30 Harvey Road, Bedford, New Hampshire 03110. The Technical Services Department can be reached by phone at (603)-622.0212.

#### **Limit of liability and disclaimer of warranty**

While Metronics, Inc. exercised great care in the preparation of this book, Metronics makes no representations or warranties with respect to the accuracy or completeness of the contents of this book and specifically disclaims any implied warranties of merchantability or fitness for a particular purpose. The advice, methods and instructions contained in this book might not be suitable for your situation. When in doubt regarding suitability, you are encouraged to consult with a professional where appropriate. Metronics shall not be liable for any loss of profit or any damages, including but not limited to special, incidental, consequential or other damages.

#### **Trademarks**

Metronics is a registered trademark of Metronics, Inc. and its subsidiaries in the United States and other countries and may not be used without written permission. Other trademarks are the property of their respective owners.

Metronics part number: 11A10562

Publishing date: June, 2005

# Introduction

This User Guide describes the operation of the video edge series of QC5200 metrology products. This series of QC5200 instruments conducts a wide variety of precise 2-D measurements using a wide assortment of video edge detection probes. The QC5200 software supports manual part positioning and feature measurement under user control, and CNC part positioning and automated measurement under program control. While it is likely that this Guide includes some material that doesn't apply to your specific QC5200 system, information pertaining to your system will be easy to find using the Table of Contents and Index.

## Who should read this Guide?

This Guide is necessary for the efficient operation of the QC5200 system. Operators and supervisors will find the contents invaluable in conducting measurements, programming automatic functions and reporting results. User setup functions are also described that will help users and supervisors customize the QC5200 measurement tools, user interface screens and report formats.

## Prerequisites

Operators and supervisors are assumed to have a good basic understanding of dimensional metrology theory and practice, and a good understanding of Microsoft Windows use and conventions.

## Conventions used throughout this Guide

The conventions used to call attention to notes, cautions and warnings, and the shorthand used to show menu navigation paths are described below:

### Notes, warnings and cautions

This guide uses the following icons to highlight note, warning and caution information:



#### **NOTE**

**The note icon indicates additional or supplementary information about an activity or concept. Notes are shown in bold type.**

**CAUTION**

The exclamation point icon indicates a situation or condition that can lead to equipment malfunction or damage. Do not proceed until the caution message is read and thoroughly understood. Caution messages are shown in bold type.

**WARNING**

The raised hand icon warns of a situation or condition that can lead to serious equipment damage, personal injury or death. Do not proceed until the warning is read and thoroughly understood. Warning messages are shown in bold type.

## Menu path navigation

Throughout the Guide, many references are made to screens that must be displayed by clicking the mouse cursor on a series of menu items and screen tabs. This kind of navigation path is demonstrated in this example of displaying the *Tools/Customize/Colors* screen, shown in text as: Tools/Customize/Colors.

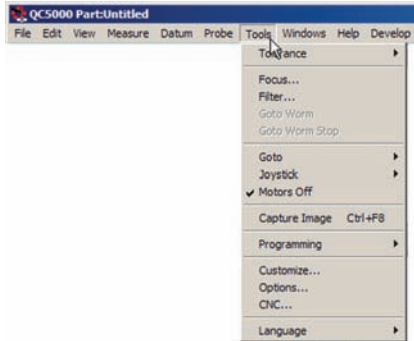

*Clicking the Tools menu item...*

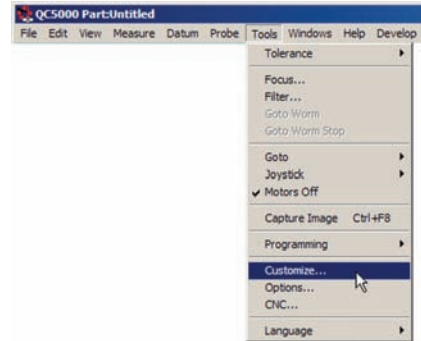

*then clicking the Customize menu item...*

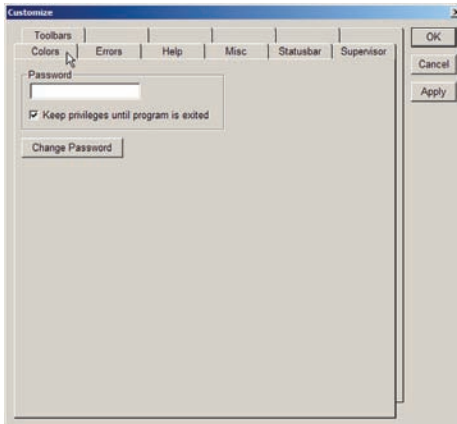

*then clicking the Colors tab...*

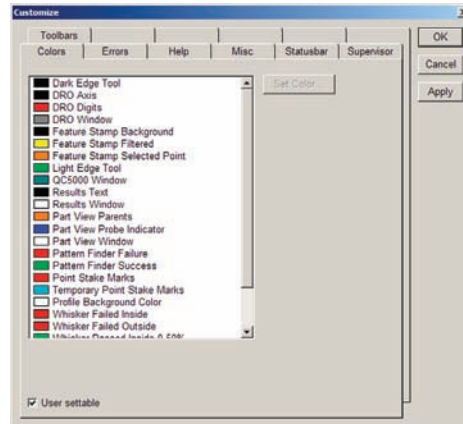

*displays the Tools/Customize/Colors screen*

## On-screen menu commands

Many commands are displayed by right-clicking the mouse cursor in a window, and then on one or a series of menu items. This kind of command path is demonstrated in this example of using the Part View window/Print Part View command to print the part view. The command is shown in text as: Part View window/Print Part View.

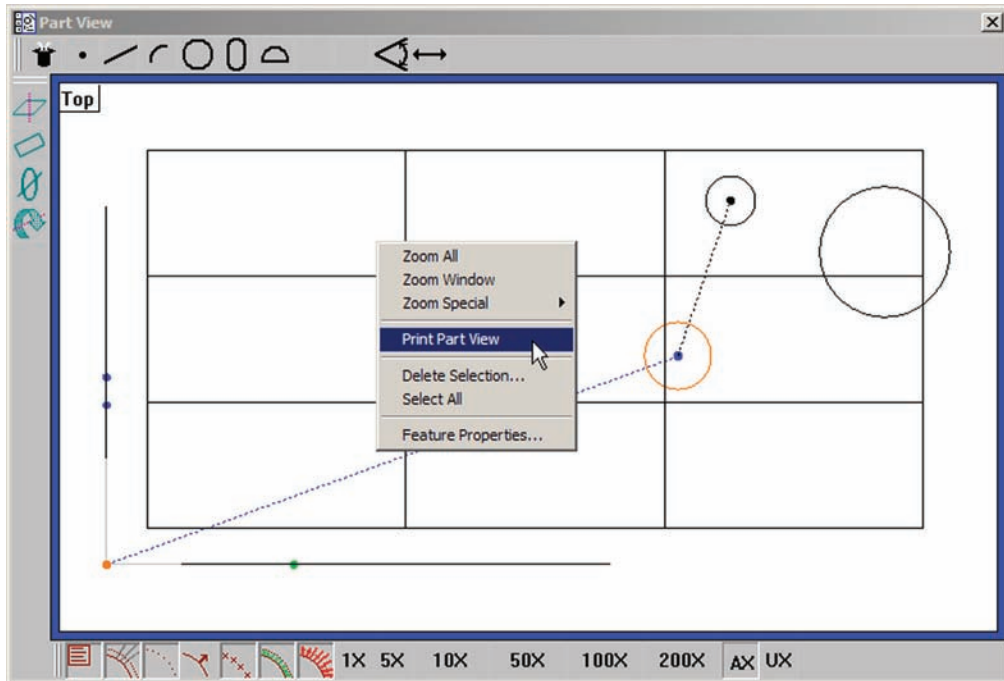

*Right-clicking the Part View window, then clicking Print Part View prints the current part view*

## Guide organization

This Guide contains eleven chapters and three reference appendices. An overview of the contents is provided below. Experienced users are encouraged to familiarize themselves with the first six chapters before beginning to use the QC5200. Users that are new to the QC5200 and similar Metronics products should read the first six chapters carefully and then follow the tutorial in [Chapter 3: Quick Start Demonstration](#) before beginning.

### **Table of contents**

#### **Chapter 1: System overview**

Brief introduction to the QC5200 series features and benefits

#### **Chapter 2: User interface**

Comprehensive description of the user interface covering screens, menus, toolbars the statusbar and workspaces.

#### **Chapter 3: Quick Start Demonstration**

Brief demonstration of using the basic functions of the QC5200 including:

- Organizing the workspace
- Selecting and teaching the probe
- Recording measurement activities as a program
- Measuring & constructing datums
- Measuring features
- Applying tolerances
- Exporting data
- Reporting
- Saving the part and program

#### **Chapter 4: Probes**

Instructions for calibrating and using video edge detection measurement probes

#### **Chapter 5: Measuring**

Instructions for constructing datums and measuring, constructing and creating features.

#### **Chapter 6: Tolerancing**

Instructions for applying tolerances to measurements.

#### **Chapter 7: Reporting and templates**

Instructions for organizing, formatting, exporting and printing measurement results.

#### **Chapter 8: Programming**

Descriptions of programming functions and instructions for creating, editing, and debugging programs.

## ***Chapter 9: Encoder Setup***

Instructions for calibrating and configuring axis encoders.

## ***Chapter 10: Supervisor Setup***

Descriptions of setup tools and screens used to configure and customize measurement, programming and display parameters

## ***Chapter 11: Problem solving***

Basic troubleshooting guide in the form of a simple table of symptoms, probable causes and recommended solutions.

## ***Appendix A: File Formats***

## ***Appendix B: ASCII Codes***

## ***Appendix C: Tolerances***

## ***Index***



## Safety first!

The QC5200 is inherently safe, and in proper use few if any potential safety hazards exist. However, many systems include motorized CNC stages that, as is the case with all motorized equipment, must be treated with caution to avoid collision and pinch injuries. Also, an entire system often consists of electrical equipment connected by many cables, which must be treated with care to avoid shock and tripping injuries.



### **WARNINGS - AXIS MOTION**

**Always stay clear of axis motion paths.**

**Disconnect axis motor power when motor activities are not required.**

**Be prepared to depress the emergency off mushroom switch or other similar device quickly in the event of an emergency when motor axes are active.**



### **WARNINGS - ELECTRICAL**

**Disconnect the system components from electrical sources before cleaning or servicing.**

**Do not allow any power cord or signal cable to be located such that it can be walked on or create a tripping hazard.**

The system components are equipped with 3-wire power plugs that include a separate ground connection, or are grounded through a separate wire. Always connect the power plug to a 3-wire grounded outlet. The use of 2-wire power plug adapters or any other connection accessories that remove the third grounded connection create a safety hazard and should not be permitted. If a 3-wire grounded outlet is not available, ask your electrician to provide one. Never disconnect any separate ground wire.

**Do not open the QC5200 enclosure. There are no user-serviceable components or assemblies inside.**

## General safety precautions

General safety precautions must be followed when configuring, maintaining or operating the system. Failure to observe these precautions could result in damage to the equipment, or injury to personnel.

It is understood that safety rules within individual companies vary. If a conflict exists between the material contained in this guide and the rules of a company using this system, the more stringent rules should take precedence.

Additional safety information is included throughout the remainder of this guide.

## General Maintenance

Disconnect the QC5200 from the power source and seek the assistance of a qualified service technician if:

- The power cord is frayed or damaged or the power plug is damaged
- Liquid is spilled or splashed onto the enclosure
- The QC5200 has been dropped or the exterior enclosure has been damaged
- The QC5200 exhibits degraded performance or indicates a need for service some other way

## Cleaning

Use only a cloth dampened with water and a mild detergent for cleaning the exterior surfaces and display screens. Never use abrasive cleaners, and never use strong detergents or solvents. Only dampen the cloth, do not use a cleaning cloth that is dripping wet.

## Display Resolution and Units of Measure

Display resolutions in this guide are examples. User display resolutions are likely to vary according to the specific application. Metric units of measure are used in examples.

## Accuracy & Precision

Measurement accuracy is determined by many factors, such as the resolution of the encoders connected to axis inputs. Generally, the display resolution of the QC5200 can exceed encoder resolutions. Setting the display resolution to exceed the encoder resolution does not increase measurement accuracy.

## Getting Help

Help is available in this printed Guide, in the electronic version of this Guide accessed from the Help menu of the QC5200 software, from your Metronics distributor or system provider and directly from Metronics.

The information contained in this guide should be adequate to customize the measurement, display and programming aspects of system, and to perform the minimal setup and troubleshooting required beyond the services provided by your Metronics distributor or system provider. However, in the event that your Metronics distributor or system provider cannot provide the assistance you need, our support staff is committed to insuring your positive experience with the QC5200 series of products. To receive technical support:

### ***Routine issues***

e-mail our support staff at: [techsupport@metronics.com](mailto:techsupport@metronics.com)

## ***Urgent issues***

Telephone your Metronics distributor, or telephone our support staff at: (603) 622.0212



### **NOTE**

**If it becomes necessary to contact us directly, be prepared to supply the following information:**

- **The QC5200 series serial number (5-Digit number printed on back label)**
- **A description of the equipment attached to the QC5200 computer, including the manufacturer and model number**
- **The QC5200 software version number, found on the Help/About QC5000 menu screen**

## **Updating your QC5200 software**

The most recent version of the QC5200 software can be downloaded from the [Product Support](#) section of our web site at:

<http://www.metronics.com>

Please carefully read all the instructions and cautions published on our site regarding your software update before attempting to perform the update.

## **Additional publications for the QC5200**

Additional application or instructional information is sometimes available for download from the Product Support section of our web site at:

<http://www.metronics.com>

# Contents

## Chapter 1 System Overview

Overview of system features.....	1
----------------------------------	---

## Chapter 2 User Interface

Introduction.....	7
Windows.....	8
DRO.....	8
Templates.....	8
Results.....	8
Part View.....	8
Live Video.....	8
Menus.....	9
Toolbars.....	9
Statusbar.....	10
Windows.....	11
DRO window.....	11
Part View window.....	12
Selecting features.....	12
Adding feature data.....	13
Live Video window.....	15
Results window.....	17
Template Windows.....	18
Stacking and separating templates.....	18
Adding and deleting template content.....	19
Features template.....	20
Program template.....	20
Report template.....	20
Tolerance templates.....	21
Menus.....	22
Menubar menus.....	22
File menu.....	23
Edit menu.....	25
View menu.....	29
Measure menu.....	35
Datum menu.....	35
Probe menu.....	35

Tools menu .....	36
Windows menu .....	39
On-screen menus .....	41
Template window menus.....	41
Template edit menus .....	41
Program edit menus.....	44
Results window menus.....	46
Part View window menus .....	50
Toolbar menus.....	53
Toolbars .....	55
Changing toolbar shape .....	56
Docking and undocking toolbars .....	56
Customizing and creating toolbars .....	57
Statusbar.....	58
Workspaces.....	59
Creating custom workspaces .....	59
Saving custom workspaces .....	60
Opening custom workspaces .....	60

## Chapter 3 Quick Start Demonstration

Demonstration steps.....	64
Organizing the workspace.....	65
Selecting templates .....	65
Teaching the video probe.....	66
Turning program recording ON.....	66
Measuring part skew and datum .....	67
Skew .....	67
Datum .....	67
Measuring features.....	69
Applying feature tolerances.....	70
Adding data to the Runs template.....	71
Exporting data.....	72
Printing reports .....	73
Turning program recording OFF .....	73
Saving the part .....	74
Running the program .....	74

## Chapter 4 Probes

Preparing to use video probes.....	77
System and part condition .....	77
Selecting video magnification .....	77

Adjusting light control.....	77
Associating lighting with magnifications .....	77
Enabling and disabling light associations.....	78
Using video probes .....	78
Selecting a probe type.....	79
Changing probe position.....	79
Changing probe orientation .....	79
Changing probe size .....	80
Changing scan direction .....	80
Changing edge detection order .....	81
Enabling and disabling high accuracy scanning.....	82
Firing video probes .....	83
Dry firing probes .....	83
Continuous probe firing.....	83
Loading a video chart .....	84
Video probe descriptions .....	85
Crosshair probe.....	86
Simple probe .....	87
Buffer Probe.....	89
Average probe.....	91
Nearest probe .....	93
Farthest probe .....	94
Height probe .....	95
Width Probe .....	97
Circle Probe .....	98
Circles.....	98
Arcs.....	99
Blob Probe .....	101
Worm probe .....	102
New probe.....	105
Pattern Finder probe .....	108
Initial setup of the video probe system .....	116
Adding magnifications with associated zooms.....	116
Adding magnifications to the Probe toolbar.....	117
Adding the highest magnification to the probe library.....	118
Adding other magnifications and associating Zoom positions .....	119
Deleting magnifications.....	120
Configuring the highest magnification .....	121
Configuring the lower magnifications .....	121
Calibrating auto focus.....	122
Calibrating video edge recognition (Teach) .....	124
Advanced Edge Teach .....	126

Calibrating pixel resolution .....	127
Calibrating offset .....	129
Compensating for camera skew .....	132
Configuring video probe data collection parameters .....	135

## Chapter 5 Measuring

Measurement activities .....	138
The measurement workspace .....	138
The measurement process .....	138
Preparing to use video probes .....	139
Establishing the measurement reference .....	139
Leveling the part (optional) .....	139
Creating a skew alignment .....	140
Creating a datum zero point .....	141
Probing a datum zero point .....	141
Constructing a datum zero point .....	142
Probing and measuring features .....	144
Measure Magic .....	144
Probing features .....	144
Probing specific feature types .....	146
Points .....	146
Lines .....	147
Arcs .....	148
Circles .....	149
Slots .....	151
Distances .....	152
Angles .....	153
Blobs .....	155
Profile measurements .....	156
Constructing features .....	172
Point constructions .....	173
Line constructions .....	178
Distance constructions .....	185
Circle constructions .....	191
Arc constructions .....	194
Creating features .....	196
Creating a point .....	197
Creating a line .....	197
Creating a distance .....	198
Creating a circle .....	198
Creating an arc .....	199

## Chapter 6 Tolerancing

Applying tolerances to features .....	203
Tolerance screens.....	203
Tolerance menu .....	204
Tolerance toolbar .....	204
Display of tolerance results .....	205
Naming and saving tolerances .....	206
Deleting Named Tolerances .....	206
Tolerance types .....	207
Bidirectional .....	207
True position.....	208
MMC/LMC (Material condition) .....	209
Runout.....	210
Circularity .....	211
Straightness.....	211
Concentricity.....	211
Profile .....	212
Parallelism .....	213
Perpendicularity .....	213
Angularity .....	213
Angle.....	214
Width .....	214

## Chapter 7 Reporting and Templates

Template descriptions .....	217
Features template.....	217
Program template.....	218
Runs template .....	219
Runs charts.....	220
Report template.....	222
Tolerance templates .....	223
Opening templates .....	224
Generating new default templates.....	224
Editing templates .....	225
Adding and deleting data .....	225
Adding data .....	225
Adding multiple data fields as a single new column.....	226
Adding multiple data fields as multiple new columns .....	227
Appending data fields to an existing column .....	228
Deleting data.....	229
Deleting rows.....	229



Deleting columns.....	230
Sorting data within a column.....	230
Aligning column titles and data.....	231
Changing the order of columns.....	231
Displaying horizontal and vertical grid line.....	231
Headers and footers.....	232
Showing headers and footers.....	232
Editing headers and footers.....	233
Adding text.....	233
Editing text.....	233
Formatting text.....	234
Including automatic text entry.....	235
Prompting the user for alphanumeric information.....	235
Deleting text.....	236
Enabling text to speech output.....	236
Adding graphics from files.....	236
Drawing graphics.....	238
Printing reports.....	241
Exporting data.....	242
DDE Output.....	243
Output parameters.....	243
Connection.....	243
Data.....	244
General guidelines.....	244

## Chapter 8 Programming

Introduction.....	249
Creating Programs.....	250
Creating the new part.....	251
Starting program recording.....	251
Performing a skew and datum.....	251
Choosing a measurement programming method.....	251
Adding tolerances.....	254
Reporting results.....	254
Optimizing program steps.....	254
Adding special steps to a program.....	255
Finalizing feature properties.....	257
Finalizing program properties.....	258
Stopping program recording.....	261
Saving the part.....	261

Editing Programs .....	262
Part fixturing .....	262
Program runtime environment .....	262
Palletizing multiple parts .....	262
Editing initial program settings .....	265
Probe position indicator .....	266
Template state .....	266
Light controls .....	267
Optical magnification .....	267
Probe selection .....	267
High accuracy mode .....	268
Focus lock .....	268
Units of measure .....	268
Editing feature properties .....	269
Hiding features .....	269
Displaying phantom features .....	269
Displaying guide features .....	269
Showing a note with a feature .....	270
Showing the feature name .....	270
Editing feature point filtration .....	270
Specifying a filtration error limit .....	271
Specifying a filtration standard deviation range .....	271
Adding special and CNC program steps .....	272
Comment .....	272
Delay .....	273
Play sound .....	273
Program image .....	274
User message .....	274
Enabling or disabling run time graphic displays .....	275
Enabling or disabling full CNC mode .....	275
Enabling or disabling power assist mode .....	276
Enabling or disabling focus lock .....	276
Setting output lines .....	277
Selecting program steps .....	278
Selecting individual steps .....	278
Selecting groups of steps .....	278
Clearing step selections .....	281
Editing individual steps .....	282
Changing the target position for probing .....	282
Changing parents of construction features .....	283
Requiring user interaction to complete a measurement .....	284
Optimizing program steps .....	285

Cutting, copying, pasting and deleting program steps.....	285
Cutting steps .....	285
Copying steps .....	285
Pasting steps .....	285
Deleting steps .....	285
Inserting new program steps .....	286
Debugging programs.....	287

## Chapter 9 Encoders

TTL encoders .....	289
Analog encoders.....	290
Joystick setup and limiting maximum axis velocity .....	290
Axis velocity .....	291
Curvature joystick parameter .....	291
Axis displacement.....	291
Counter setup .....	292
Limit Switch setup .....	292
Calibrating analog encoders.....	293
QC5200 encoder setup.....	296
Specifying encoder resolution .....	296
Specifying encoder unit of measure .....	296
Specifying encoder count direction .....	296
Specifying encoder reference marks.....	296
Specifying reference offsets .....	297

## Chapter 10 Supervisor Setup

Tools/Customize menu item screens .....	299
Including a startup message.....	300
Customizing colors .....	301
Specifying on-screen help tips.....	305
Specifying error messages .....	306
Specifying status bar information.....	308
Customizing toolbars .....	309
Tools/Options menu item screens.....	314
Setting up programming parameters.....	314
Specifying the maximum program executions .....	317
Restricting access to setup screens .....	318
Configuring measurement parameters.....	320
Displaying parts and probe position .....	322
Configuring joystick and footswitch buttons.....	327
Setting the display of resolution, time and date.....	330

Specifying encoder parameters..... 331  
 Specifying file names, locations and backups ..... 332  
 Setting serial port, machine zero and general parameters ..... 337  
 Setting up the video probes..... 340  
 Tools/CNC menu item screens ..... 350  
 Setting up the joystick ..... 350

**Chapter 11 Problem Solving**

QC5200 settings or appearance have changed. Everything looked  
 okay the last time you were on the system, now it's different..... 355  
 A QC5200 Window is missing from the screen, but is enabled  
 in the QC5200 Windows menu ..... 355  
 Measurements are inaccurate or inconsistent ..... 355  
 An axis counts in the wrong direction ..... 356  
 Cannot drag data fields from the Results window into a template ..... 357  
 Changes to the QC5200 settings, window positions, etc. are not saved..... 357  
 The QC5200 program doesn't launch, but other Windows programs do ..... 358  
 Cannot print from the QC5200 program..... 359  
 A default template contains unwanted data or formatting ..... 360  
 Cannot make changes to the QC5200 settings..... 361  
 The system seems slow..... 362  
 Cannot see image in the live video window ..... 363  
 The auto focus does not work properly..... 364  
 The measurements finish before I'm ready ..... 365  
 Cannot find captured images ..... 365

**Appendix A Import File Formats**

**Appendix B ASCII Codes**

**Appendix C Tolerances**

Concentricity tolerance  
 Reference Features  
     Reference feature called for in MMC or LMC circle tolerance  
 Projected zone

**Index**

# Chapter 1: System Overview

The Metronics QC5200 series of metrology instruments is a family of Windows PC-based products for conducting precision dimensional measurements on 2-D parts. Systems can be supplied with video systems and measuring microscopes. Systems support manual part positioning and feature measurement under user control, or CNC part positioning and automated measurement under program control.

All QC5200 systems consist of a Windows-based user interface and a dedicated Metronics axis PC card. All axis cards include input circuitry for reading the axis position. Axis cards in systems capable of CNC axis motion control also include circuitry for driving CNC stepper motor or CNC servo motor amplifiers.

All systems measure 2-D part features in the X-Y plane. Additionally, systems can include a Z-axis input for height measurements and part leveling and a Q-axis for rotational measurements.

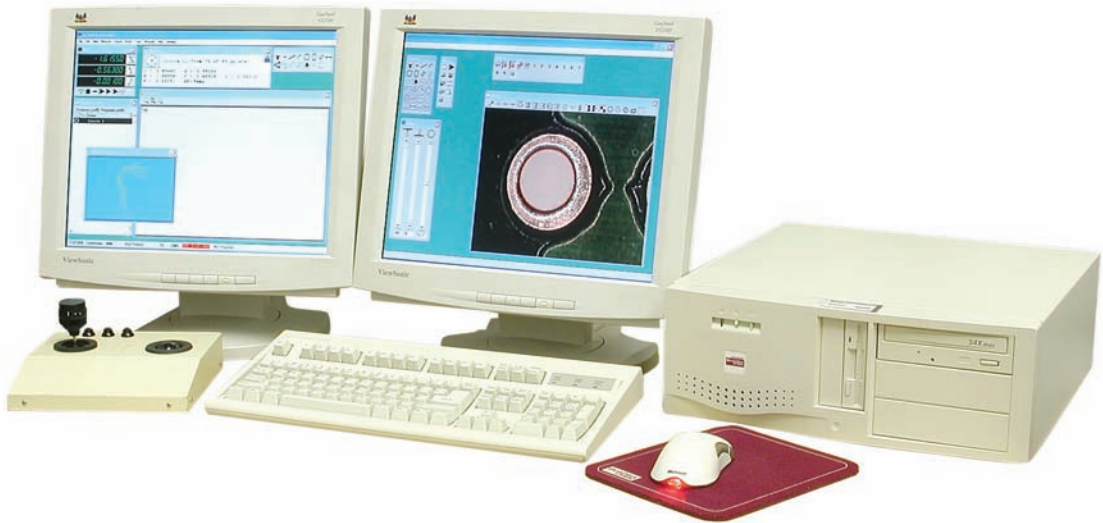

*Basic QC5200 for video systems or microscopes with joystick part positioning*

Part features can be measured, constructed from measured features, created from user data, copied from existing features or imported from .dxf, .igs and other files.

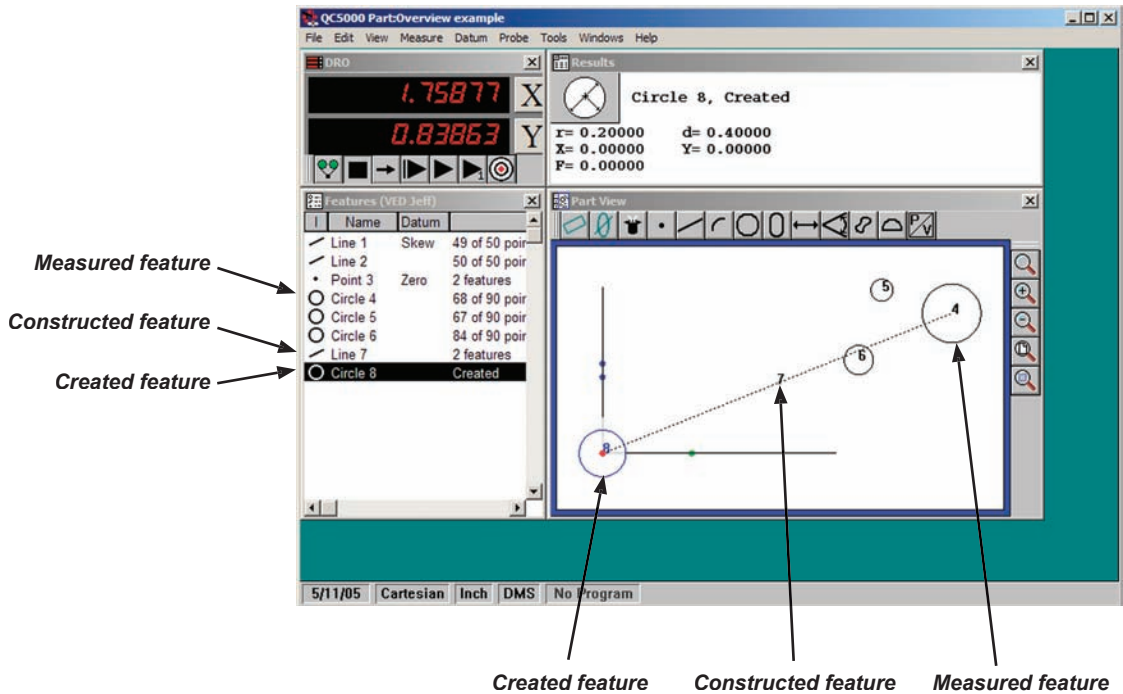

Geometric tolerances include location, form, orientation, runout and size. In addition, tolerances can be applied to groups of selected features.

Tolerances are context sensitive. For example, straightness is provided for lines and circularity is provided for circles. Tolerances can be displayed for evaluation and the tolerance criteria can be edited with a few clicks of the mouse, as shown in this example of a form tolerance.

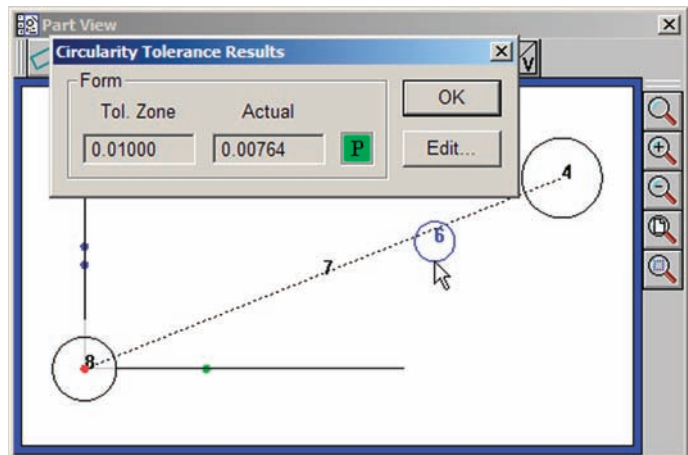

Programs can be created in manual systems to semi-automate repetitive tasks and simplify operator interactions, or in systems that include CNC control to automate measurements eliminating measurement errors and increasing throughput. Programs can be recorded automatically as a series of measurements are performed, can be created to include conditional branching and messages, can be edited in static or single-step modes and can be created from imported CAD files. The task of programming is simplified by programming wizards and a comprehensive program debugging environment.

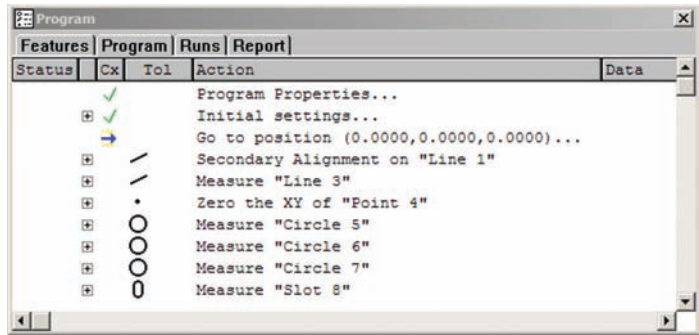

*Example of a program recorded automatically as measurements were performed*

Reports can be custom-formatted in a wide variety of formats to satisfy the requirements of different audiences by simply dragging and dropping data selections into templates. Templates can easily be customized. Completed reports can be archived, printed, exported or saved for e-mailing. Exported data can be sent to CAD applications, Microsoft Excel and Microsoft Access for processing.

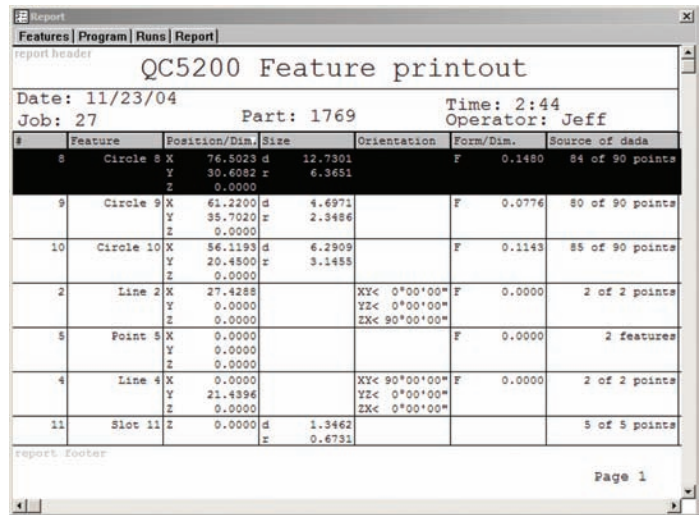

*Example of a report of feature data*

The user interface conforms to standard Windows conventions and can be quickly mastered by experienced Windows users. Task-specific menus, icons and toolbars further simplify interactions with QC5200 features and measurement functions. Many aspects of the user interface can be customized to suit the needs of each user. Customized arrangements of windows and toolbars can be saved as unique workspaces to facilitate the most efficient use of the system by different users.

This User's Guide can be accessed and displayed from the Help menu, and includes links from all page references in the Table of Contents and Index to Guide content.

# Chapter 2:

## User Interface

The QC5200 user interface is a workspace consisting of menus, windows, toolbars and a statusbar. The overall appearance of the user interface can vary greatly and can be customized to satisfy the requirements and personal preferences of the user. The following pages contain a detailed description of the QC5200 user interface. Here's what you'll find in this chapter:

Introduction .....	7
Windows .....	8
Menus .....	9
Toolbars .....	9
Statusbar .....	10
Windows .....	11
DRO window .....	11
Part View window .....	12
Live Video window .....	15
Results window .....	17
Template Windows .....	18
Stacking and separating templates .....	18
Adding and deleting template content .....	19
Features template .....	20
Program template .....	20
Report template .....	20
Tolerance templates .....	21
Menus .....	22
Menubar menus .....	22
File menu .....	23
Edit menu .....	25
View menu .....	29
Measure menu .....	35
Datum menu .....	35
Probe menu .....	35
Tools menu .....	36
Windows menu .....	39



On-screen menus.....	41
Template window menus.....	41
Template edit menus.....	41
Program edit menus.....	44
Results window menus.....	46
Part View window menus.....	50
Live Video window menus.....	51
Toolbar menus.....	53
Toolbars.....	55
Changing toolbar shape.....	56
Docking and undocking toolbars.....	56
Customizing and creating toolbars.....	57
Workspaces.....	59
Creating custom workspaces.....	59
Saving custom workspaces.....	60
Opening custom workspaces.....	60
Launching the QC5200 program into a specific workspace.....	61

# Introduction

The QC5200 user interface is a workspace consisting of windows, menus, toolbars and a statusbar. The overall appearance of the user interface can vary greatly and can be customized to satisfy the requirements and personal preferences of the user. However, the individual elements of every workspace are consistent in purpose and function, and do not significantly change. Workspace elements include:

- The DRO, Template, Results, Part View and Live Video windows
- Menu bar and on-screen menus
- Toolbars
- Statusbar

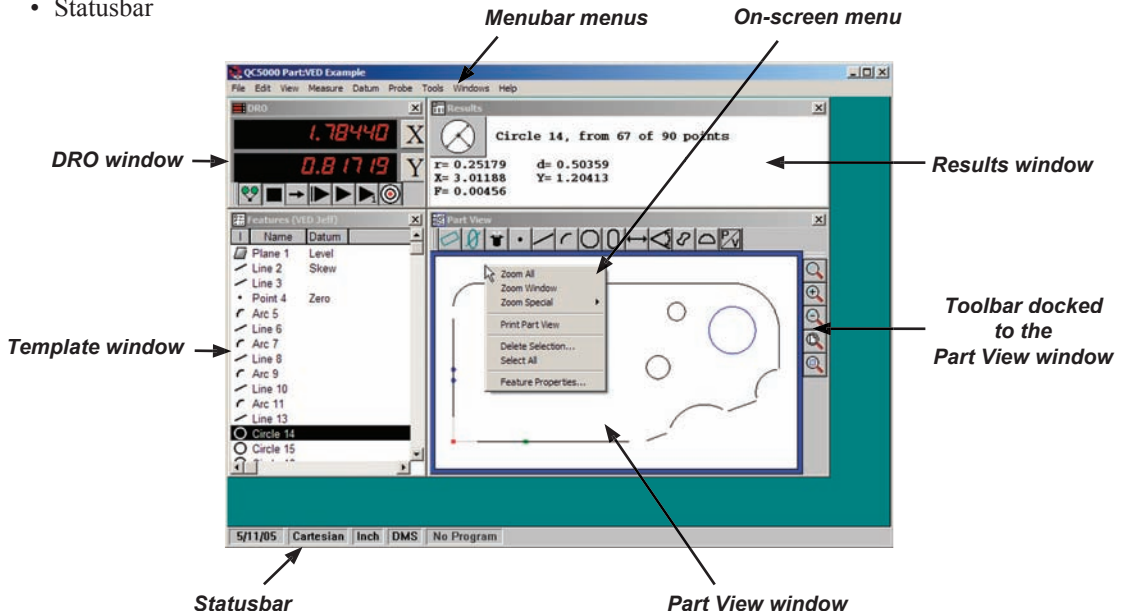

The overall appearance of the user interface, or workspace, can be customized to vary greatly as shown here, but individual workspace elements remain essentially unchanged.

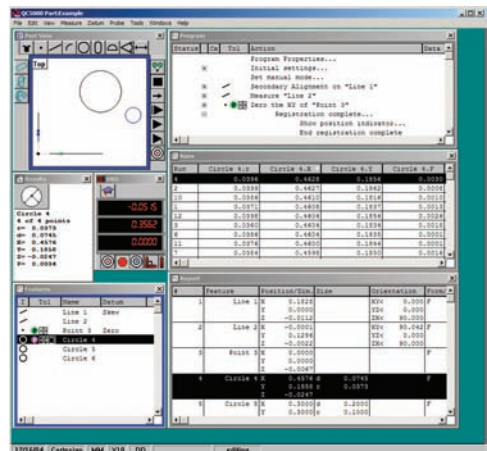
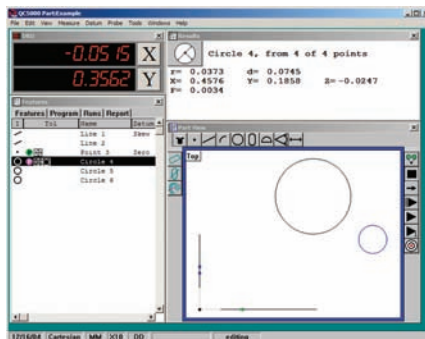

## Windows

Four window types are used to present numeric, text and graphic information:

- DRO
- Templates
- Results
- Part View
- Live Video

### DRO

The Digital Readout (DRO) presents numeric position information for each axis.



### Templates

Template windows present tabular data describing features, programs, runs database contents and tolerance measurements. The template windows shown here are stacked. However, each window can be presented alone.

I	Name	ZXa	F	r	X	Y	Da
/	Line 1	90.000	0.0000		0.1828	0.0000	Sk
/	Line 2	90.000	0.0005		-0.0001	0.1286	
•	Point 3	0.0000			0.0000	0.0000	Z:
○	Circle 4	0.0034	0.0373	0.4576	0.1858		
○	Circle 5	0.0000	0.1000	0.3000	0.3000		
○	Circle 6	0.0000	0.1000	0.3000	0.3000		

### Results

The Results window contains measurement data related to a feature selected in a template or in the Part View window.

Circle 4, from 4 of 4 points

r= 0.0373	d= 0.0745
X= 0.4576	Y= 0.1858
F= 0.0034	Z= -0.0247

### Part View

The Part View window contains a graphic display of the measurement reference frame and measured features.

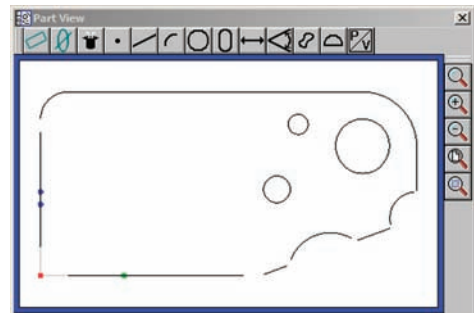

### Live Video

The Part View window contains a real-time display of the video camera image including the part view at the active magnification with the active video probe superimposed over the part image.

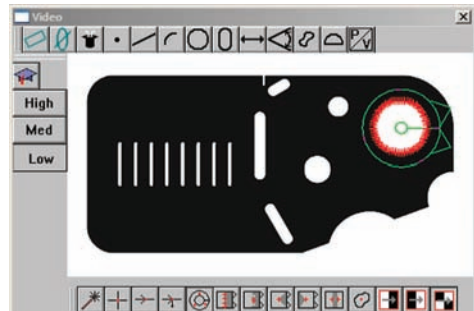

## Menus

Menus contain functions that control file operations, editing, measurements, displayed information and overall system configuration and setup. Menus can be accessed by clicking on a menu item in the menubar, or by right-clicking areas in the workspace.

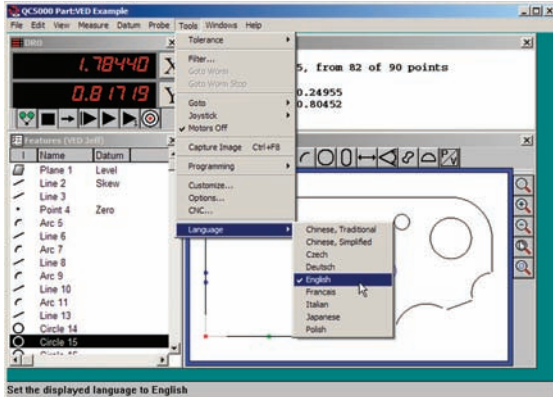

*Menu accessed from the menubar*

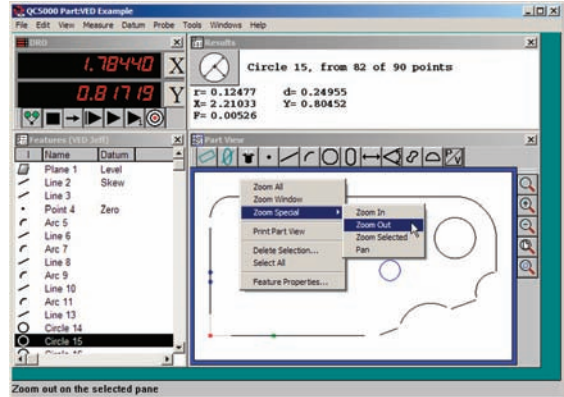

*Menu accessed by right-clicking a window*

## Toolbars

Toolbars like the examples below contain icons that provide quick access to functions that are also provided by menus. Toolbars can be located nearly anywhere within the workspace, and can be docked to most windows.



*Measure toolbar*



*Program toolbar*



*Datum toolbar*

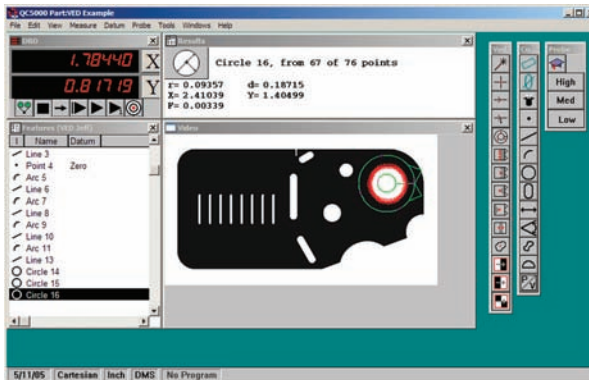

*Separate toolbars*

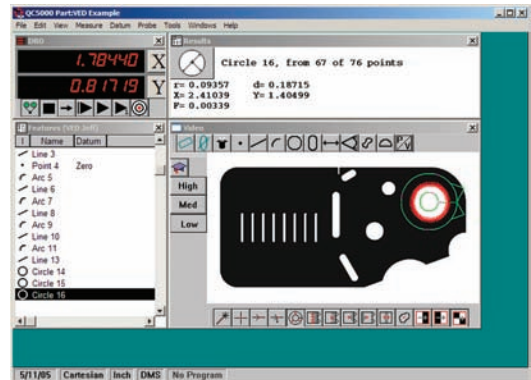

*Toolbars docked to the Part View window*

## Statusbar

The statusbar presents information regarding units of measure, current measurements, programming and other system status information across the bottom of the workspace. The information in the statusbar changes to support current activities.

The statusbar changes to display brief definitions when the mouse hovers over a menu command, as in this example of a statusbar definition displayed when hovering over the Datum zero menu command.

**Measures or constructs a zero point**

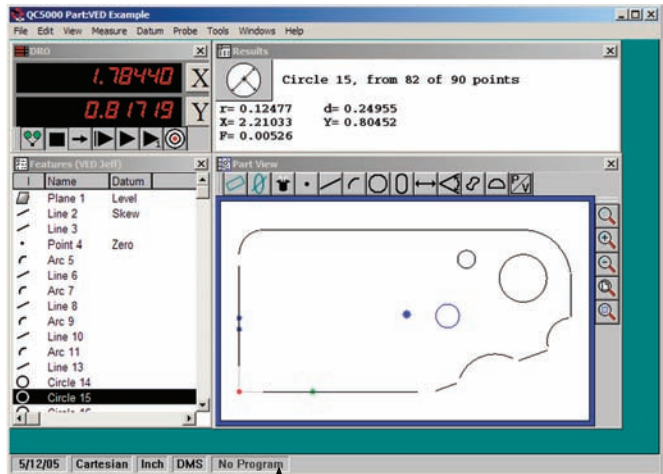

**Statusbar**

## Windows

Windows present numeric, text and graphic information describing probe position, feature measurement results, tolerance measurement results, program content and measurement database statistics.

Windows include:

- DRO (digital readout) window: Probe position referred to the current measurement reference (machine zero or part zero)
- Part View window: Graphic display of measured features
- Results window: Measurement result data
- Live Video window: Real-time display of video camera image and active video probe
- Templates: Eight default templates display feature data, program steps, database and report statistics and tolerance measurement results. Additional custom templates can be created by the user.

### DRO window

The DRO window shows the current probe position with respect to the zero position of the current reference frame.

Check the Windows/DRO menu item to display the DRO window, or clear the check mark to hide it.

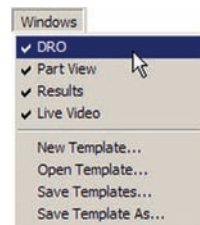

The zero location of each axis can be temporarily changed by clicking the axis button on the right side of the DRO window.

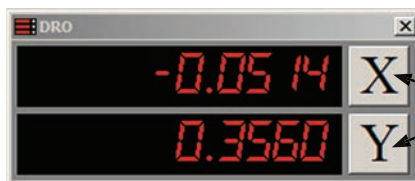

Axis zero buttons



#### NOTE

The X and Y axis Cartesian coordinates are changed to R and  $\Theta$  for polar coordinate systems.

The DRO window can be resized by clicking and dragging the side or corner of the window.



## Part View window

The Part View window contains a graphic display of the current measurement reference frame and all measured features. This Part View window shows features of the Metronics quickie slide and docked toolbars. Check the Windows/Part View menu item to display the Part View window, or clear the check mark to hide it.

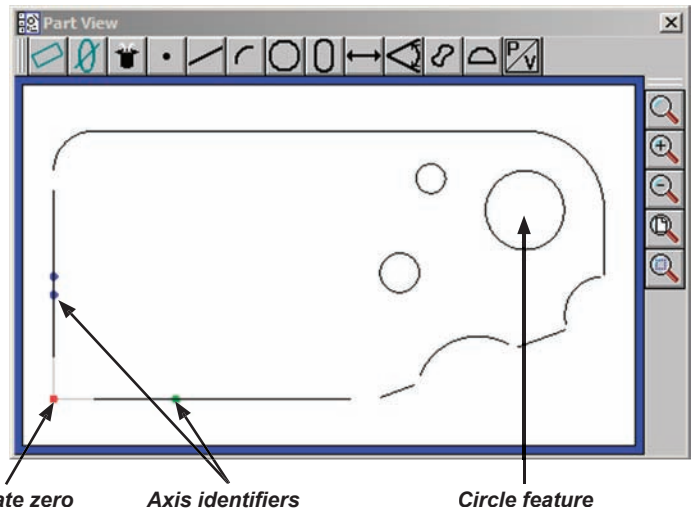
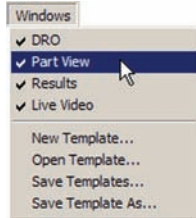

*Coordinate zero*

*Axis identifiers*

*Circle feature*

The current reference frame is shown as X and Y axes and a coordinate zero point. The X-axis is identified by a single green dot and the Y-axis by two blue dots.

## Selecting features

A single part feature or multiple features can be selected by clicking features while pressing the Control key, or by dragging a marquee across the desired features.

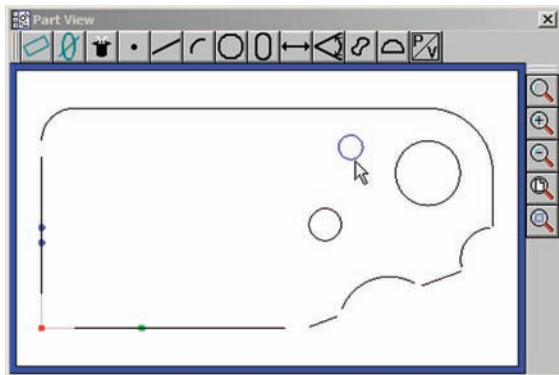

*Selecting features by clicking them*

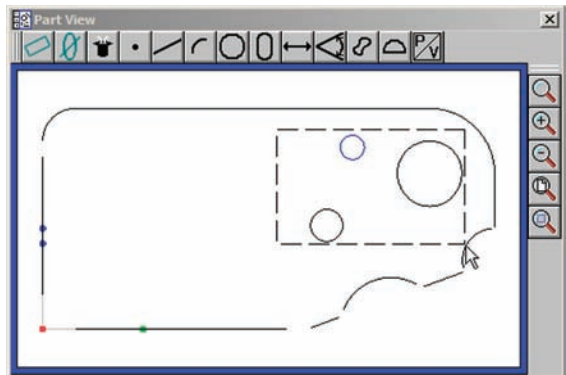

*Selecting features by dragging a marquee*

When the marquee is dragged across features from left to right, all features touched by the marquee are selected.

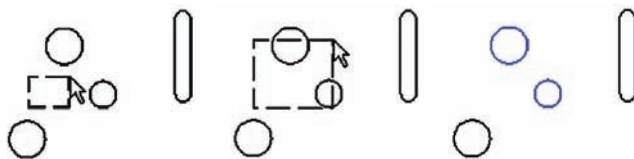

*Dragging the marquee from left to right selects all features touched by the marquee*

When the marquee is dragged across features from right to left, only features completely enclosed by the marquee are selected.

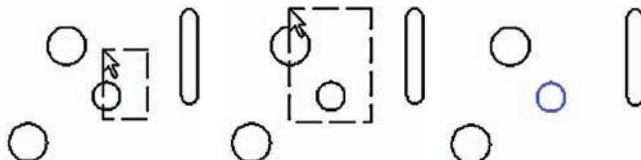

*Dragging the marquee from right to left selects only features completely enclosed by the marquee*

### Adding feature data

Feature data can be added to the Part View window by clicking and dragging the desired data for a selected feature from the Results window to the Part View window.

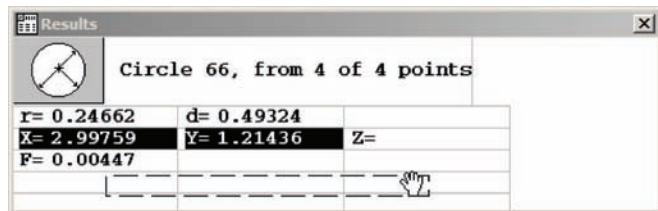

*Data for the selected feature is clicked and dragged...*

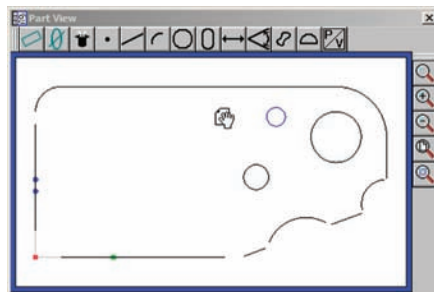

*into the Part View window*

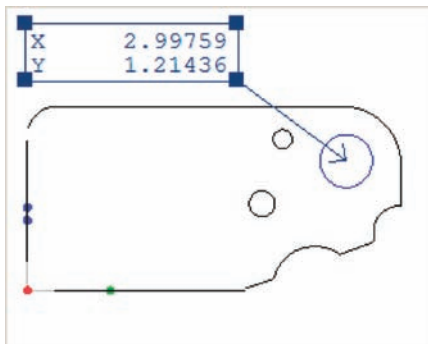

*The feature data can then be...*

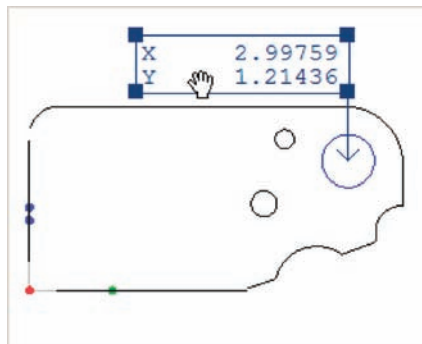

*clicked and dragged to the desired position*



Zoom and other Part View window functions can be accessed by clicking the Windows/View menu or by right-clicking in the window. These functions are described in detail later in the Menus section of this chapter.

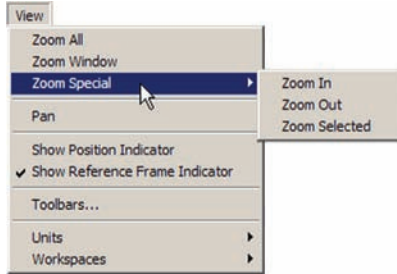

*Accessing functions from the Menubar*

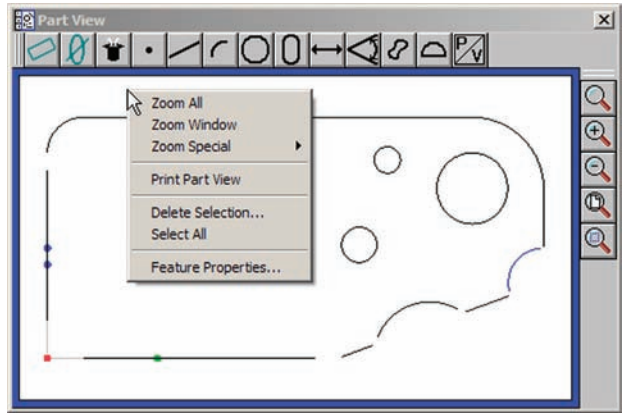

*Accessing functions from the on-screen menu*

The Part View window can be resized by clicking and dragging a corner of the window.

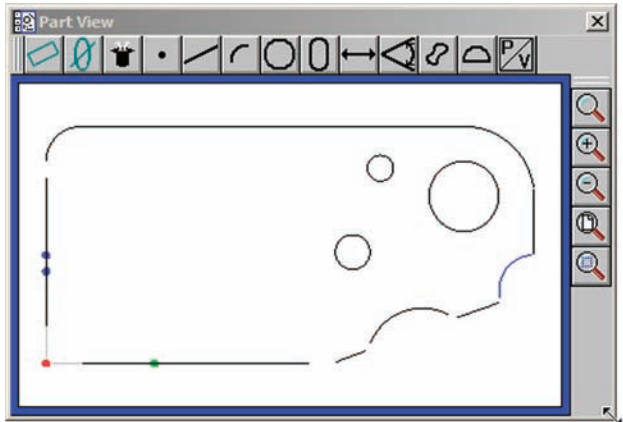

*Click and drag a corner to resize the window*

## Live Video window

The Live Video window displays a real-time image from the video camera. The active video probe is shown superimposed over the image.

Check the Windows/Live Video menu item to display the Live Video window, or clear the check mark to hide it.

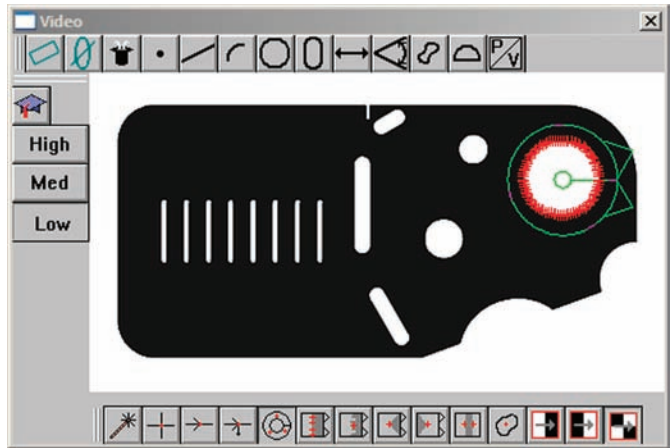
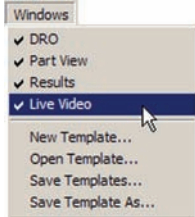

The image size is controlled by the Probe/Magnification menu and the Probe toolbar.

Click the desired Probe/Magnification menu item or Probe toolbar button to change the camera magnification.

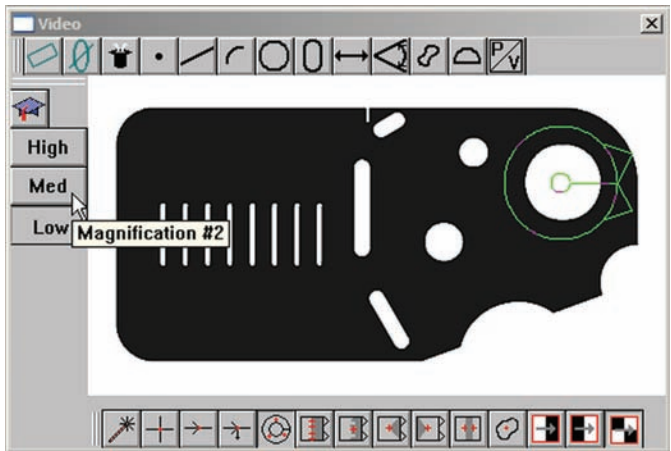
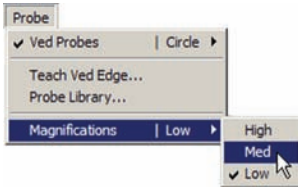

Click the Probe menu...

or Probe toolbar to change the camera magnification

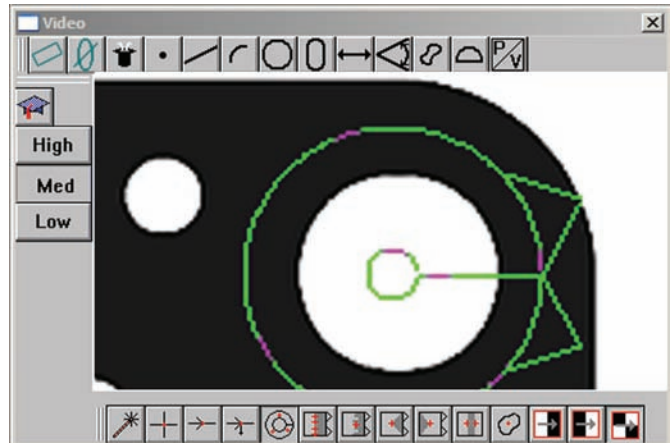

The display of live video typically appears in its own screen space when two monitors are used.

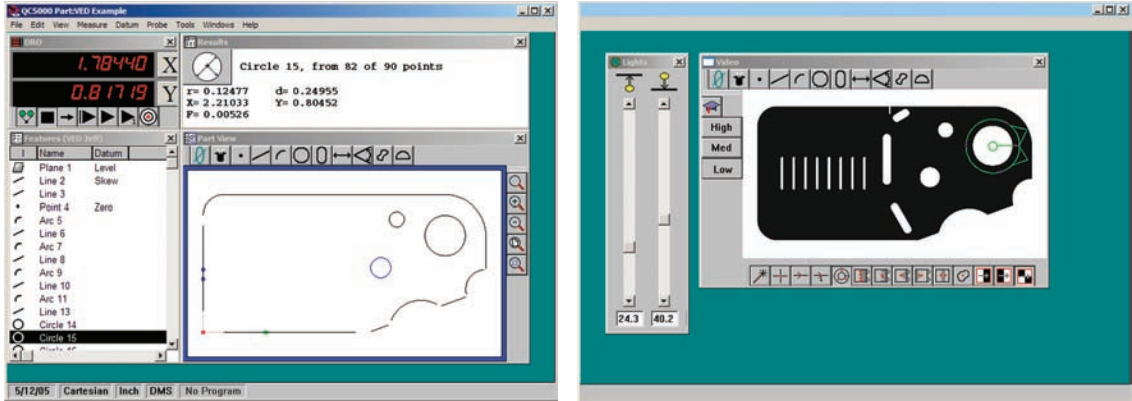

*The Live Video window appears in its own screen space when two monitors are used*

However, the display can be toggled between the Live Video window and the Part View window to conserve screen space when only a single monitor is used. Position the Live Video window directly over the Part View window, matching the window sizes, then click the P/V toolbar button  to toggle between the two windows.

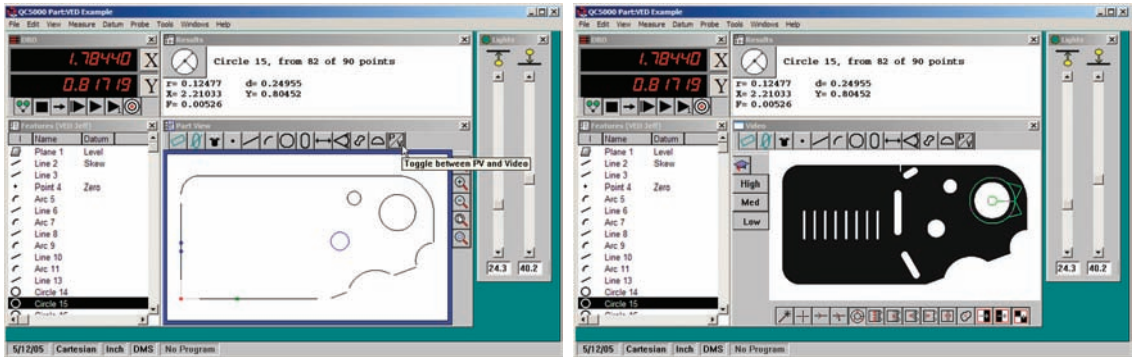

*The Part View and Live Video windows share screen space on a single monitor using the P/V toolbar button*

## Results window

The Results window contains measurement data for the selected feature.

Check the Windows/Results menu item to display the Results window, or clear the check mark to hide it.

All basic feature data is displayed for the current coordinate system. The information changes to reflect the new coordinate system when the measurement coordinate system is changed by the user.

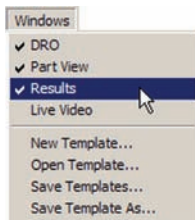
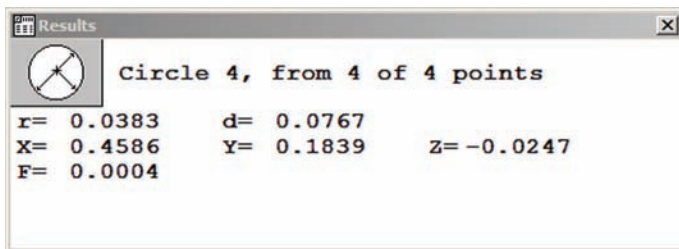

Results window functions can be accessed by right-clicking the window. These functions are described in detail later in the Menus section of this chapter.

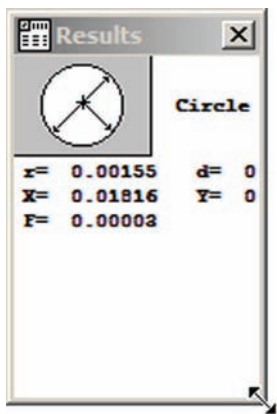

*Simply changing the overall shape doesn't change the text formatting*

The size and shape of the Results window can be changed by clicking and dragging a corner, but the content's text format remains unchanged when this method is used.

To change the text formatting of the Results window, right-click the title bar of the Results window to display the Results window menu, then highlight the desired Results window text format and release the mouse. The new format will be displayed.

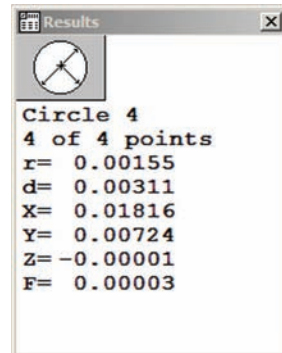
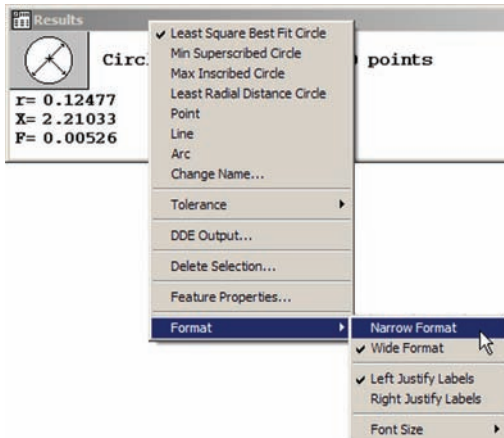

*Text formatting must be changed from the Results window menu*

## Template Windows

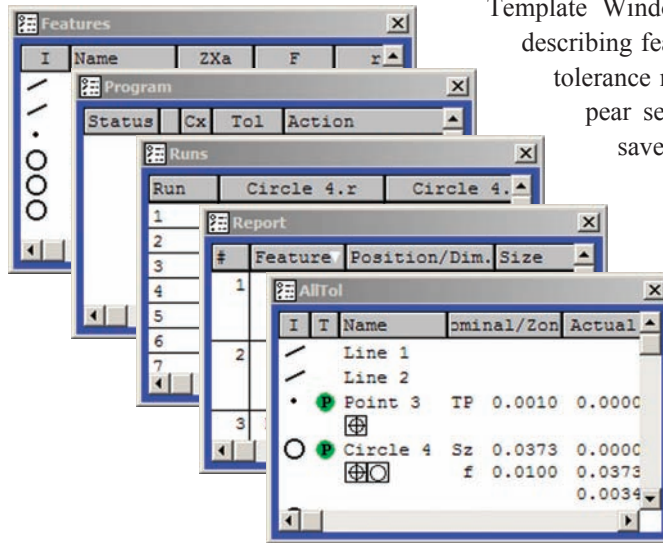

*Template windows presented separately*

Template Windows present tabular data and information describing features, programs, runs database content and tolerance measurements. Template Windows can appear separately, or can be tabbed and stacked to save screen space.

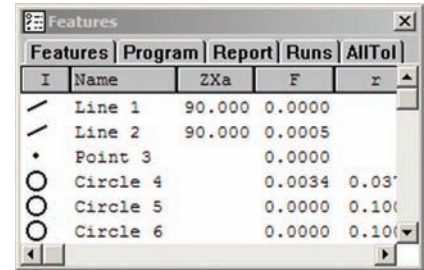

*Template windows tabbed and stacked*

Check the desired template title in the recent template portion of the Windows menu to display the template, or clear the check mark to hide it.

If the desired template is not shown in the list of recent templates, click the Windows/Open Template menu item to select and open it, or right-click the Template window and open a new template from the on-screen menu. Menubar and on-screen menu functions are described in detail later in the Menus section of this chapter.

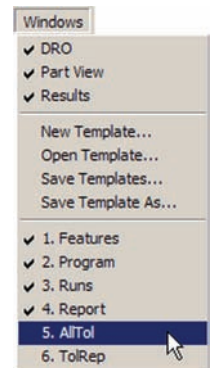

### Stacking and separating templates

Stack the templates by dragging and dropping one template onto another.

Unstack templates that you wish to appear separately by clicking and dragging the title tab of one template away from the stack.

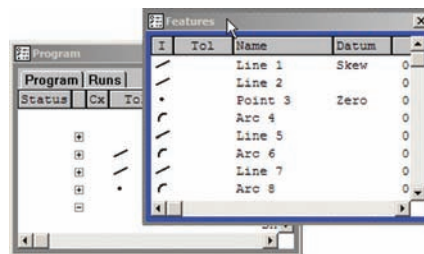

*The Feature template is dragged...*

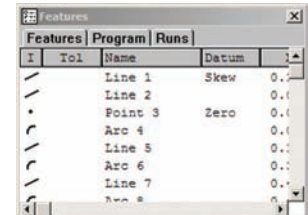

*onto the template stack*

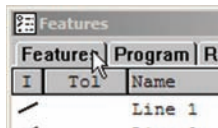

Eight default templates are included in the QC5200 system. These default templates include:

- Features
- Program
- Report
- Runs
- Tolerance (four tolerance templates are available)

### Adding and deleting template content

Each template contains default columns for displaying information appropriate for the template type. However, columns can be deleted or added to suit the needs of the user. Columns are deleted using the on-screen template menu described later in the Menus section of this chapter. Columns are added by dragging and dropping data fields from the Results window as shown in the example below.

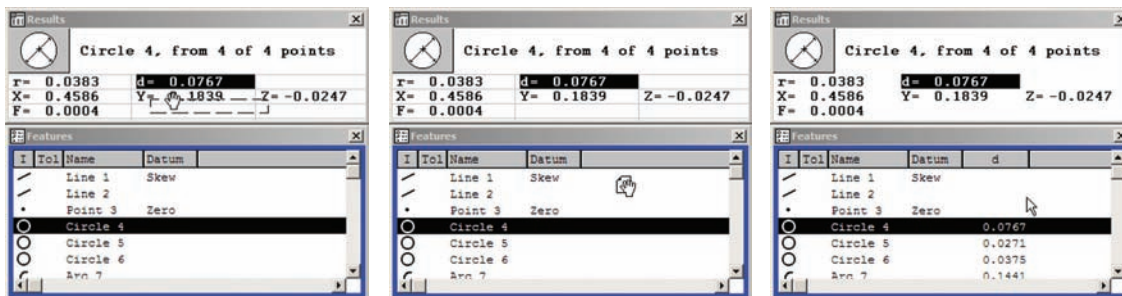

Diameter is clicked in the Results window and dragged...

from the Results window to the Features template...

to create a diameter column in the Features template



**NOTE**

When the Results window is locked in the Tools/Options/Locks setup screen, data fields cannot be dragged and dropped from the Results window into templates.

Template scrollbars provide access to information that extends beyond the fixed boundaries of the template window.

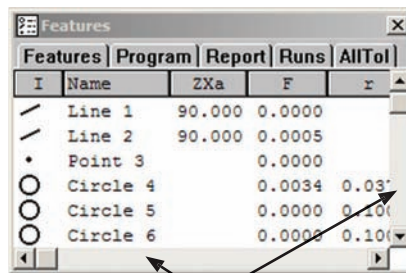

Scrollbars

## Features template

The Features template displays dimensional data for all measured, created or constructed features. Default columns include the feature icon, tolerance, feature name and datum.

Use of the Features template is described in detail in [Chapter 5: Measuring](#).

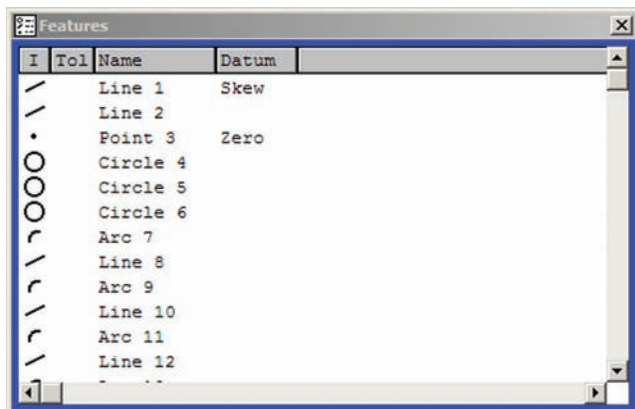

I	Tol	Name	Datum
/		Line 1	Skew
/		Line 2	
•		Point 3	Zero
○		Circle 4	
○		Circle 5	
○		Circle 6	
∩		Arc 7	
/		Line 8	
∩		Arc 9	
/		Line 10	
∩		Arc 11	
/		Line 12	

## Program template

The Program template displays a list of program steps with information that includes program status, tolerances, current step, actions to be performed and the program data such as loop executions completed.

Use of the program template is described in detail in [Chapter 8: Programming](#).

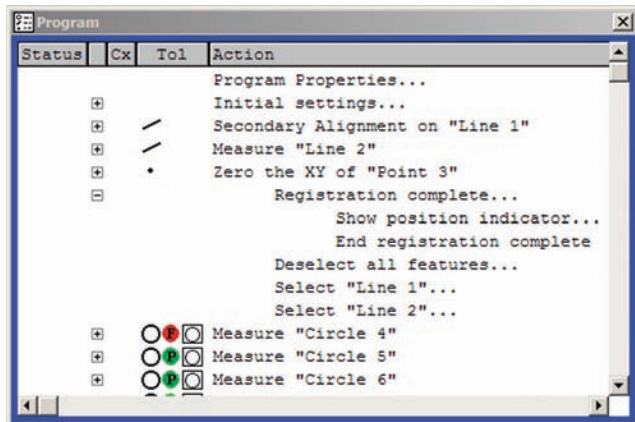

Status	Cx	Tol	Action
			Program Properties...
			Initial settings...
+	/		Secondary Alignment on "Line 1"
+	/		Measure "Line 2"
+	•		Zero the XY of "Point 3"
□			Registration complete...
			Show position indicator...
			End registration complete
			Deselect all features...
			Select "Line 1"...
			Select "Line 2"...
+	○	⊖	Measure "Circle 4"
+	○	⊕	Measure "Circle 5"
+	○	⊕	Measure "Circle 6"

## Report template

The Report template displays a tabular summary of feature data intended as the basis of printed reports of measurement results.

Use of the report template is described in detail in [Chapter 7: Reporting and Templates](#).

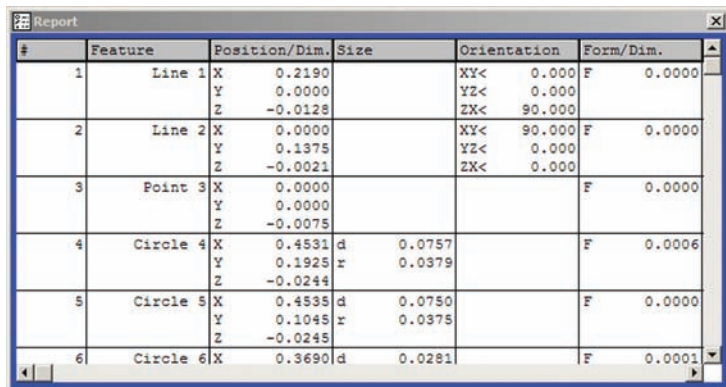

#	Feature	Position/Dim.	Size	Orientation	Form/Dim.
1	Line 1	X 0.2180 Y 0.0000 Z -0.0128		XY< 0.000 YZ< 0.000 ZX< 90.000	F 0.0000
2	Line 2	X 0.0000 Y 0.1375 Z -0.0021		XY< 90.000 YZ< 0.000 ZX< 0.000	F 0.0000
3	Point 3	X 0.0000 Y 0.0000 Z -0.0075			F 0.0000
4	Circle 4	X 0.4531 d Y 0.1925 r Z -0.0244	0.0757 0.0379		F 0.0006
5	Circle 5	X 0.4535 d Y 0.1045 r Z -0.0245	0.0750 0.0375		F 0.0000
6	Circle 6	X 0.3690 d	0.0281		F 0.0001

## Tolerance templates

Tolerance templates display tabular summaries of tolerance measurement results.

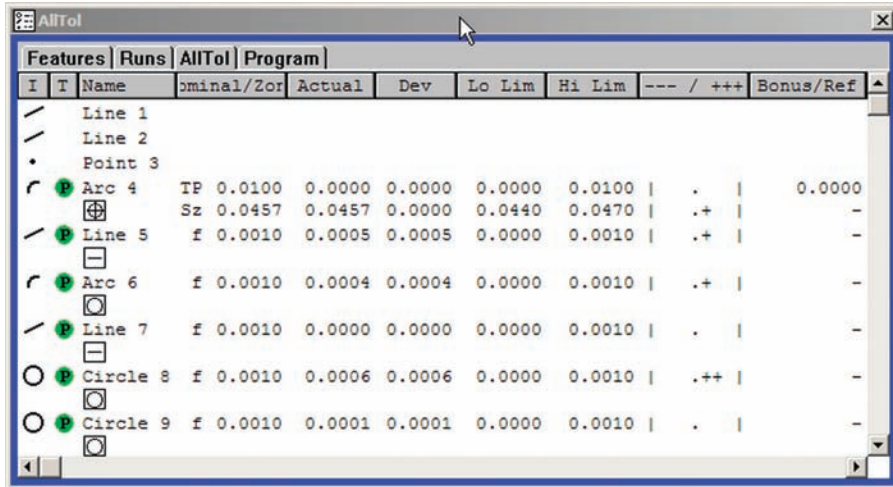

AllTol										
Features   Runs   AllTol   Program										
I	T	Name	Nominal/Zor	Actual	Dev	Lo Lim	Hi Lim	---	+++	Bonus/Ref
/		Line 1								
/		Line 2								
.		Point 3								
/	P	Arc 4	TP 0.0100	0.0000	0.0000	0.0000	0.0100		.	0.0000
			Sz 0.0457	0.0457	0.0000	0.0440	0.0470		+.	-
/	P	Line 5	f 0.0010	0.0005	0.0005	0.0000	0.0010		+.	-
/	P	Arc 6	f 0.0010	0.0004	0.0004	0.0000	0.0010		+.	-
/	P	Line 7	f 0.0010	0.0000	0.0000	0.0000	0.0010		.	-
O	P	Circle 8	f 0.0010	0.0006	0.0006	0.0000	0.0010		++.	-
O	P	Circle 9	f 0.0010	0.0001	0.0001	0.0000	0.0010		.	-

Four default Tolerance templates are available. Each template contains a feature icon, tolerance flag (pass-fail), tolerance symbol, feature name, nominal value, actual value and deviation. Tolerance templates include:

- AllTol: Complete tolerance information for all features
- EuroTol: Cartesian +/- tolerance values formatted for European users
- TolRep: Complete tolerance information for only toleranced features
- QDAS: Report of feature data formatted for European users

Use of Tolerance templates is described in detail in [Chapter 7: Database, Reporting and Templates](#).



## Menus

Menus can be displayed by clicking a menu title in the menubar, or by right-clicking certain items within the workspace area.

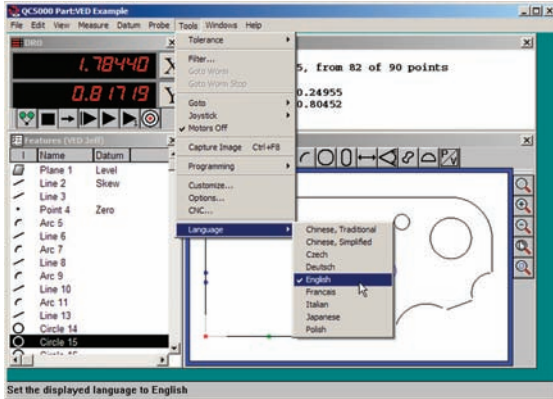

*A menu is displayed by clicking a menubar title*

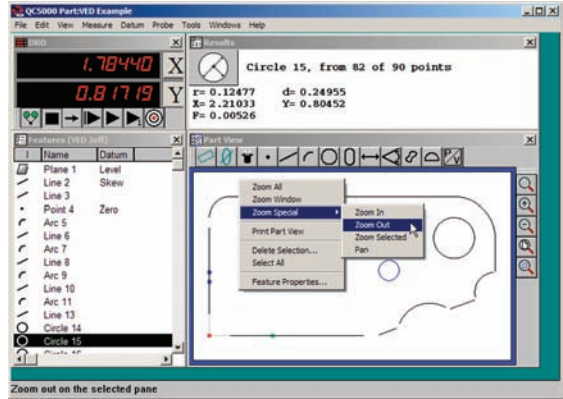

*Another menu is displayed by right-clicking an item within the workspace area*

Most menus accessed by right-clicking in the workspace area are also available in the menubar.

## Menubar menu

The menubar includes the following categories of menus:

- File: Typical Windows file and print functions
- Edit: Functions for editing features and programs
- View: Workspace viewing alternatives
- Measure: Feature measurement selections
- Datum: Reference frame creation
- Probe: Measurement probe selection and adjustment
- Tools: Tolerance, CNC, programming, setup and language functions
- Windows: Window selection and template functions
- Help: User guide, backup and diagnostic utilities

**File menu**

Most file menu functions are identical to those found in other Windows applications and are shown below:

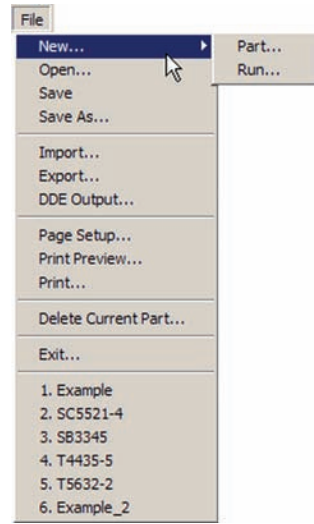

**New**

Opens a new part or initiates a new run of the current program.



**NOTE**

The QC5200 can be configured to automatically save part changes when a new program run is initiated. Refer to the Chapter 10: Supervisor Setup, Tools/Options/Files screen.

**Open**

Displays the Open Part file dialog box to select and open an existing part.

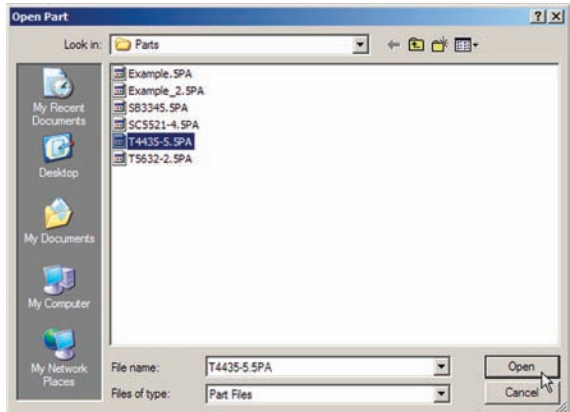

**Save**

Saves the current part and part program using its current filename. If the part is new and has no current filename, the Save Part As file dialog box will be displayed and a new filename will be required.

**Save As**

Displays the Save Part As file dialog box. The part file and part program are then saved using a filename of the user's choice.

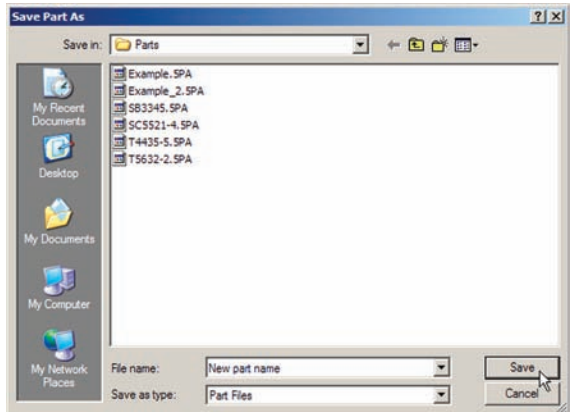

**Import**

Imports part files in one of many standard formats. Refer to Appendix A: Import File Formats for details.

### Export

Exports highlighted feature data in one of many standard file formats to a location of, and using a file name of the user's choice.

### DDE output

Exports highlighted feature data to an application of the user's choice using Microsoft's Direct Data Exchange protocol.

### Page setup

Standard Windows pre-print function for selecting and configuring a printer.

### Print preview

Displays a dialog box for selecting the source material to print and the number of copies to be printed, then displays a preview of the printer output.

### Print

Displays a dialog box for selecting the source material to print and the number of copies to be printed, then prints the material.

### Delete current part

Deletes the current part file and all associated files. Users are asked to confirm the delete request.

### Exit

Closes the QC5200 application. Users are given the opportunity to save the part file before closing.

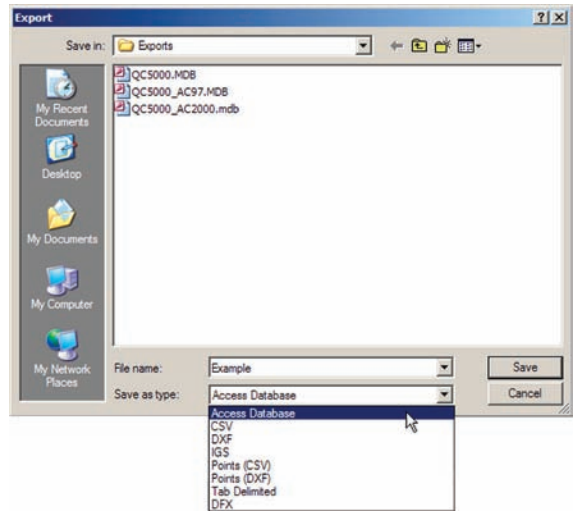

### NOTE

The QC5200 can be configured to automatically save changes to part and template files upon exiting the application. Refer to the [Chapter 10: Supervisor Setup, Tools/Options/Files screen](#).

**Edit menu**

The first seven items of the Edit menu provide standard Windows editing functions for cutting, copying, pasting, deleting and selecting elements in one of the QC5200 templates.

In the example shown below, Circles 4, 5 and 6 are selected and then copied from the Features template and pasted into a Notepad document.

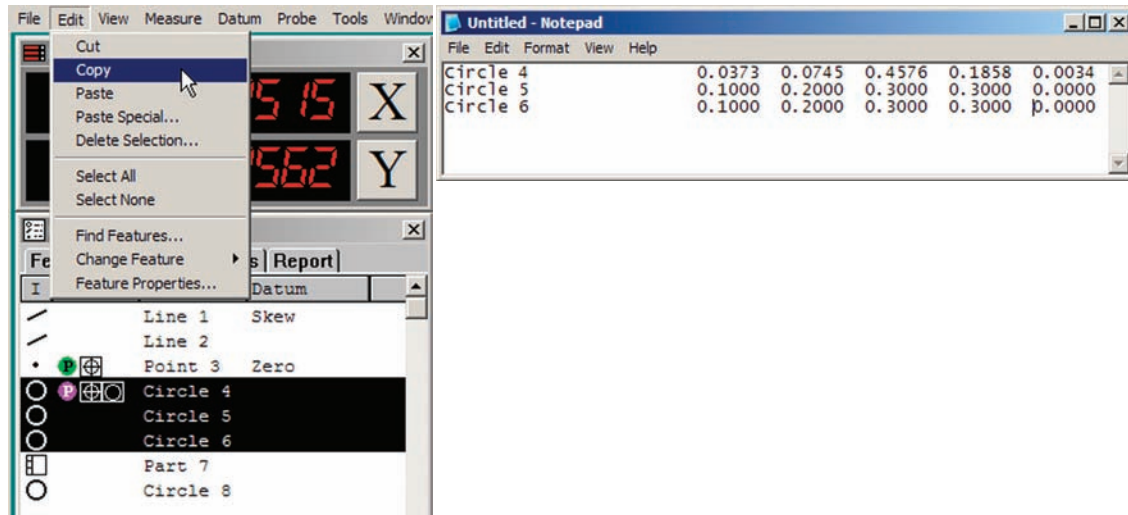
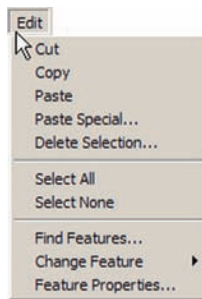

**NOTE**

The use of these standard editing functions is shown throughout the remainder of this guide as part of the many instructions and examples that follow.

## Find Features

Features listed in the Features, Report and Tolerance templates can be found and highlighted (selected) by the system. This is useful when selecting features with similar names from long lists containing many different feature types.

Clicking the Find Features menu item displays the Find Feature dialog box.

Feature names are entered directly into the Name field.

Checking the Add to Current Selection box adds the new feature(s) to any existing selections. Clearing the box replaces any existing selections with the new features.

The Find Feature function can be limited to features that passed or failed tolerance tests by checking the Passed or Failed Tolerances boxes, can find all features of the specified name by clearing both boxes, or can find only tolerated features of the specified name by checking both boxes.

Clicking the Advanced button displays the advanced Find Feature dialog box.

Advanced search criteria include characteristics listed in the Item, Condition and Value drop-down lists.

A wide variety of search criteria can be specified and then included in, or excluded from the search using drop-down lists and tool buttons on the advanced Find Feature dialog box.

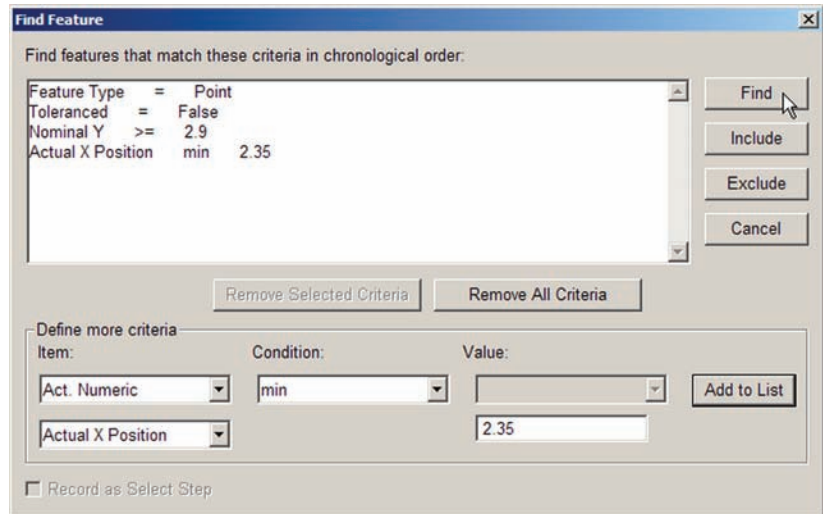
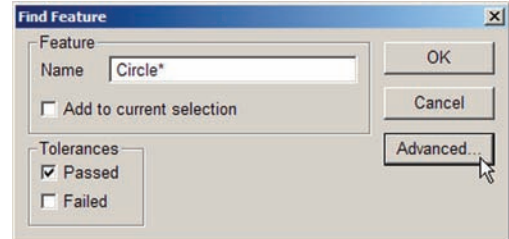
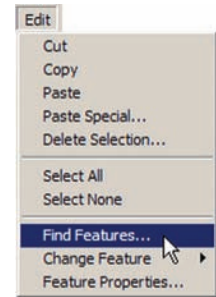

### Change feature

Features are measured by selecting feature types from the Measure menu or Measure toolbar and then probing part features. When a specific feature type is selected prior to probing, the feature data is assigned the specified feature type and cannot be changed. However, when Measure Magic is selected prior to probing, the feature type can be changed using the Change Feature menu item.



The Change Feature function is useful when one set of feature data describes different feature types. In this example, a shallow arc was interpreted as a line with marginal form, and is changed from a line to an arc in the Features list.

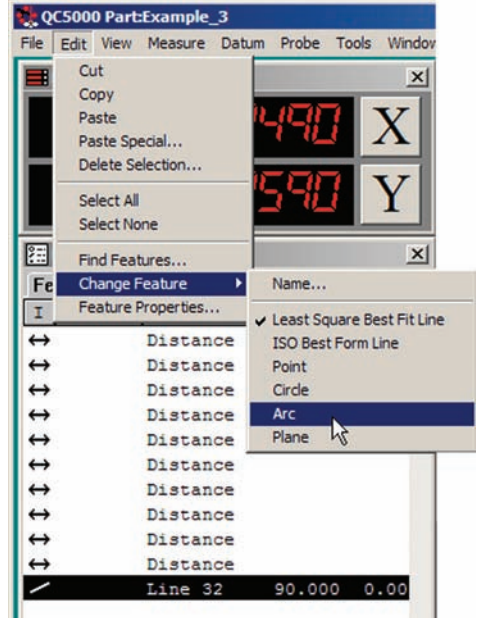

### Feature properties

The Feature Properties dialog box contains tools for specifying feature properties that include:

- Name  
The feature name
- Display/Hidden  
Hides or shows the feature in the Part View window
- Display/Phantom  
Displays the feature as a dashed line or a solid line
- Display/Guide  
Displays the feature as a guide, outlined in the Part View window during program executions
- Display/Show Note  
Displays a note over the feature in the Part View window
- Display/Show Name  
Displays the feature's name in the Part View window
- Point Filtration/Filtered  
Displays only data points within the specified sigma factor, and with errors lower in value than the specified Quantization limit

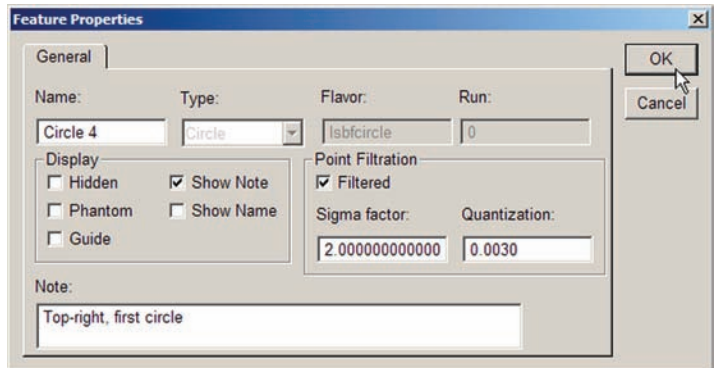
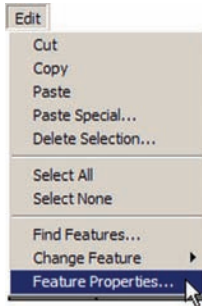

**NOTE**

Refer to **Chapter 10: Supervisor Setup** for additional details requiring display and point filtration properties.

The Type field displays the feature type and cannot be changed.

The Run field displays the program run number used to record the feature data in the runs database.

### View menu

The View menu includes functions for:

- Zooming in or out to show Part View, Feature stamp and Profile window contents at different magnifications
- Panning the contents of the Part View, Feature stamp and Profile window
- Showing the probe position in the Part View, Feature stamp and Profile window
- Showing the measurement reference frame in the Part View window
- Displaying the Toolbar selection dialog box
- Specifying English or metric units of measure
- Specifying Cartesian or polar coordinate systems
- Opening, saving or specifying workspaces

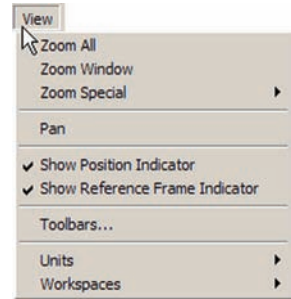

### Zoom all

Click Zoom All to automatically fit all measured features in the Part View window.

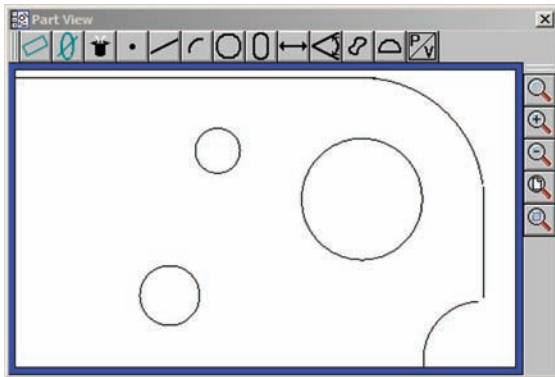
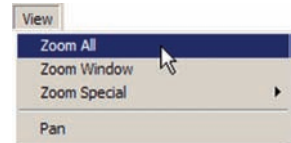

*Clicking Zoom All...*

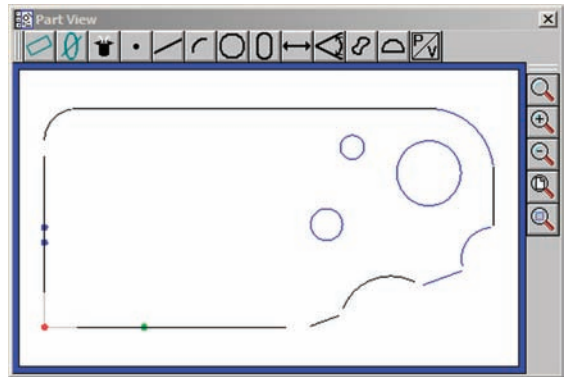

*automatically zooms to fit all features into the Part View window*



### Zoom Window

Click Zoom Window to display the magnifying glass cursor. Click and drag the cursor to select the portion of the Part View window to be magnified and fit into the Part View window.

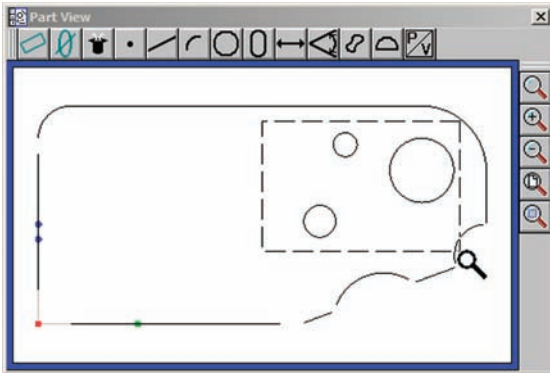
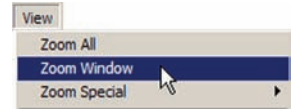

*Click and drag the magnifying glass cursor...*

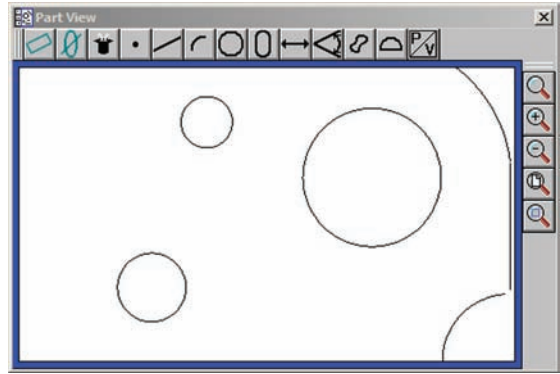

*to select an area to fit into the Part View window*

### Zoom Special

Click Zoom Special to zoom in, Zoom out or zoom to fit a selected feature or collection of features into the Part View window.

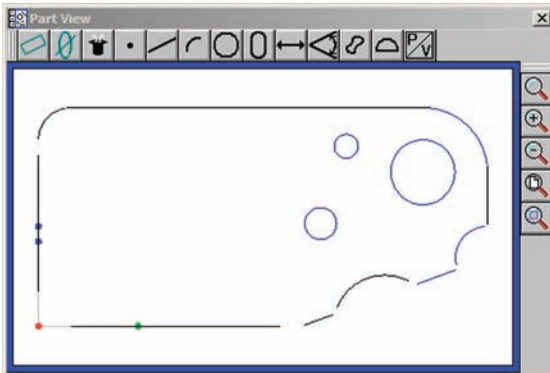

*Clicking Zoom In...*

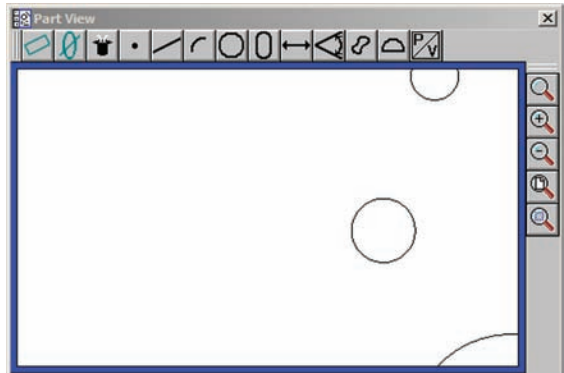

*increases the magnification without changing position*

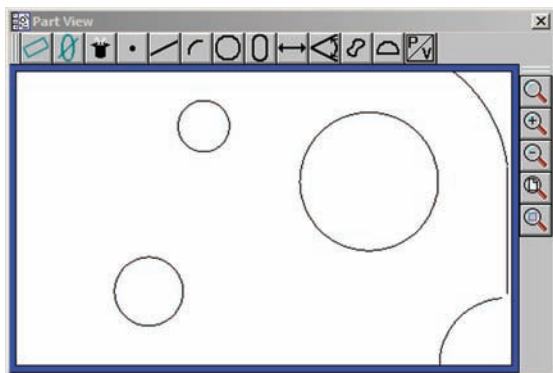

*Clicking Zoom Out...*

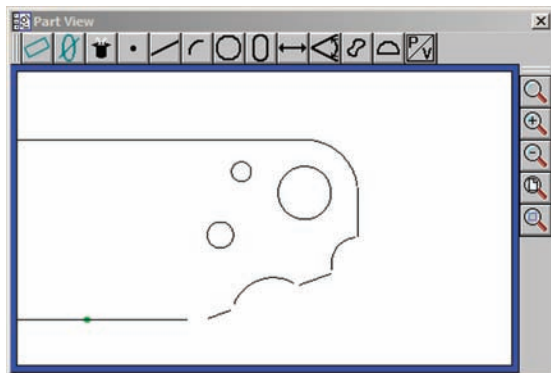

*decreases the magnification without changing position*

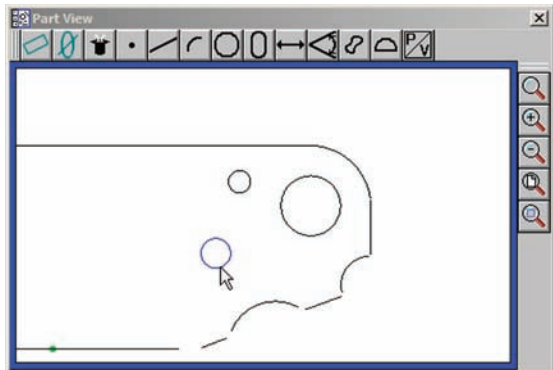

*Selecting a feature or features and clicking Zoom Selected...*

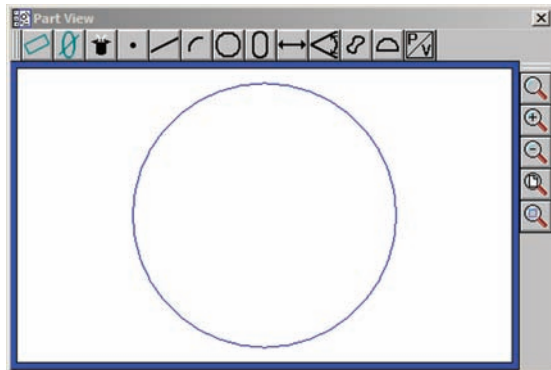

*fits the selected feature or features into the Part View window*

## Pan

Click Pan to display the hand cursor. Click and drag the hand cursor in the desired direction to reposition the image displayed in the Part View window.

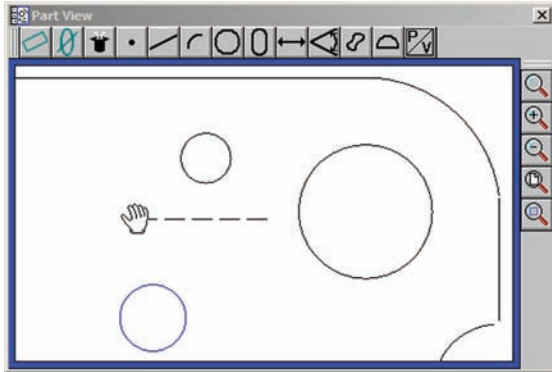
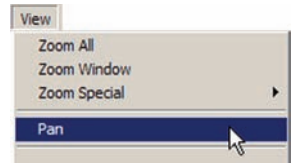

*Clicking Pan and then clicking and dragging the hand cursor...*

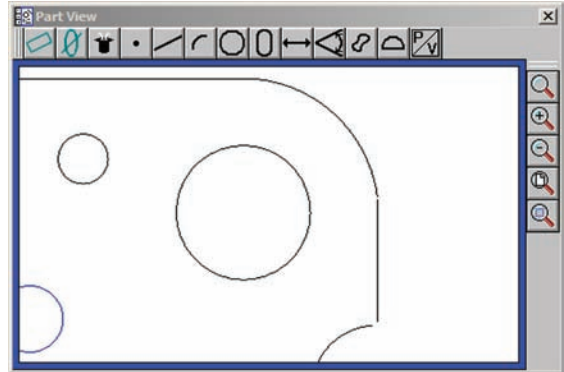

*moves the contents of the Part View window*

## Show position indicator

The position of the probe can be shown in the Part View window as a large dot by checking the Show Position Indicator menu item. Clicking the menu item toggles a check mark on and off.

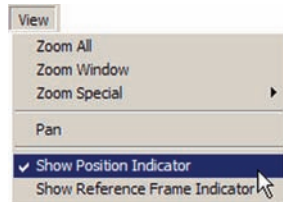
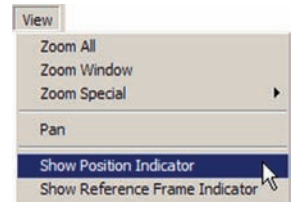

*Toggling the Position Indicator on...*

*Position indicator*

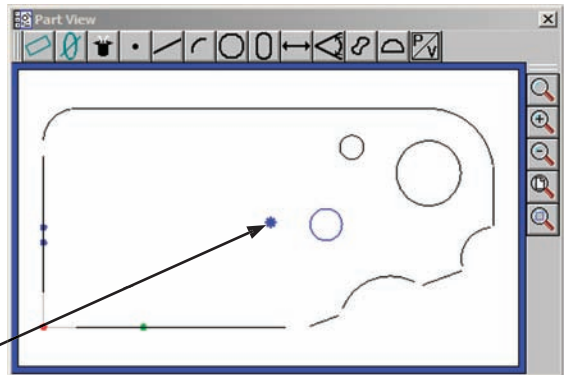

*displays the probe position as a dot in the Part View window*

**Show reference frame indicator**

The X-Y reference frame can be shown in the Part View window as large dots on the X and Y axes by checking the Show Reference Frame Indicator menu item. The X-axis is indicated by a single dot. The Y-axis is indicated by two dots. Clicking the menu item toggles the check mark on and off.

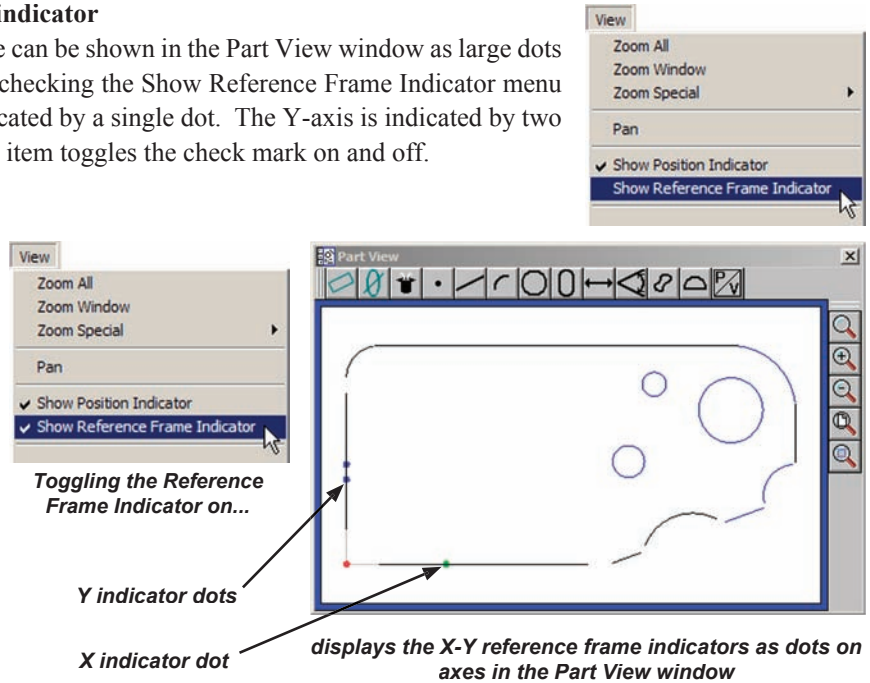

**Units**

Measurements can be shown in English or metric units, and in Cartesian or polar coordinates by checking the desired Units menu item selections. Clicking a menu item toggles the check mark on or off.

Checking Units selections displays the desired units of measure and coordinate system in the Results window and in all templates. The current units of measure and coordinate system are also displayed in the Status bar.

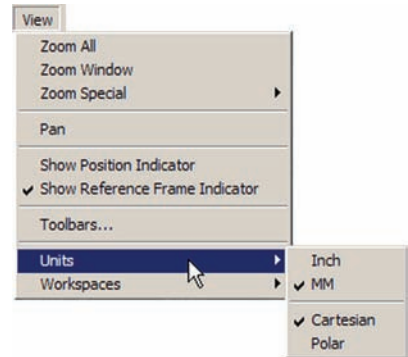

## Workspaces

Click the Workspaces menu item to open or save a workspace. Recently used workspaces are listed in the bottom section of the Workspaces drop-down menu.

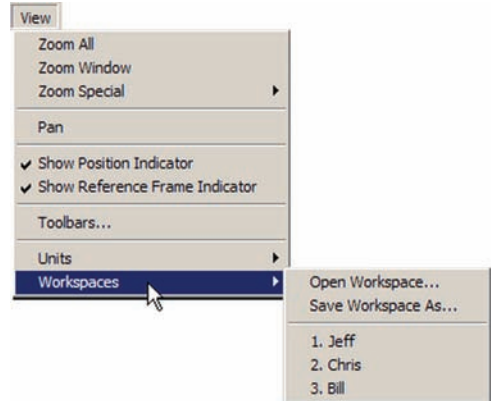

### Measure menu

The measure menu provides access to the QC5200 measurement functions. Detailed descriptions of the measurement functions are contained in [Chapter 5: Measuring](#).

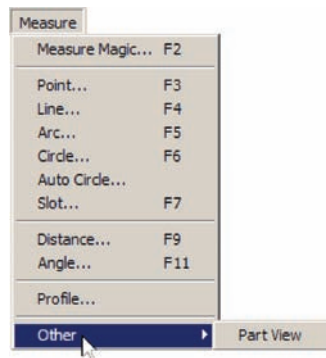

### Datum menu

The datum menu provides access to the tools required to establish a measurement reference frame. Measurement reference frame construction is discussed in detail in [Chapter 5: Measuring](#).

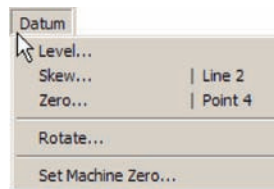

### Probe menu

The Probe menu provides access to tools for:

- Selecting a video probe
- Displaying the light control
- Associating light settings with the current camera magnification
- Enabling or disabling light w/mag function
- Calibrating the video edge detection
- Displaying the Probe Library functions
- Selecting camera magnification levels

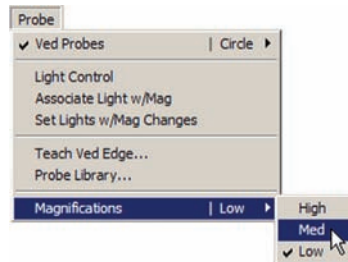
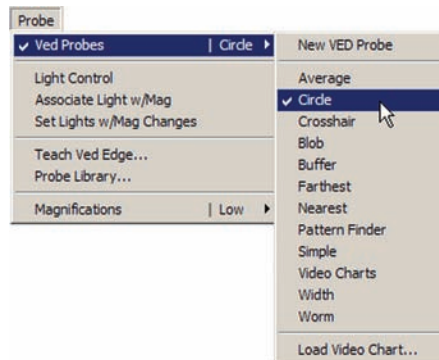

The contents of the Probe menu are described in detail in [Chapter 4: Probes](#).

## Tools menu

The Tools menu provides access to tools for:

- Conducting tolerance measurements
- Filtering the video camera image for improved edge detection
- Moving the stage to the Worm probe start or stop position
- Controlling CNC functions
- Capturing a bitmap of the current camera image
- Programming automated and semiautomatic measurements
- Configuring supervisor setup parameters for the QC5200 system
- Specifying a language for screen displays and file output



### Tolerance menu items

The menu items available for performing tolerance measurements change in support of the feature selected in the Part View window or active template.

Tolerance menu items are described in detail in [Chapter 6: Tolerancing](#).



*Tolerance menu for a line*

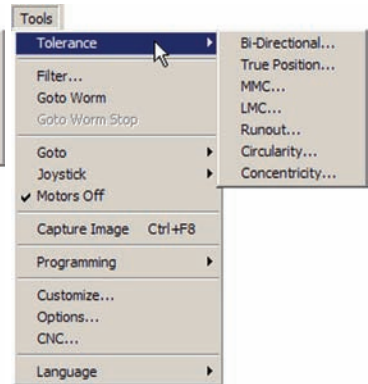

*Tolerance menu for a circle*

### Filter functions

Clicking Filter launches the image processing functions that include tools for cleaning and optimizing the camera image to improve video edge detection. The filter functions are described in detail in [Chapter 4: Probes](#).

### Goto Worm functions

Clicking Goto Worm or Goto Stop Worm sends the stage to the beginning or end of the Worm video probe path. The Goto Worm functions are described in detail in [Chapter 4: Probes](#).

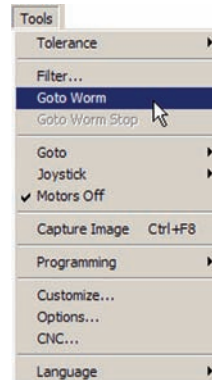

**CNC control functions**

CNC functions control the stage position, joystick behavior and CNC motors.

**Goto**

The Goto functions control the CNC stage. Clicking Goto Position moves the CNC stage to a specified coordinate. Clicking Goto Click or Goto Selected Feature moves the stage to a mouse location clicked on the Part View window or to the center of a selected feature. The Goto functions can be used anytime, but are typically used during a programming session or during program execution. Detailed descriptions of the Goto functions are contained in [Chapter 8: Programming](#).



} **CNC functions**

**Joystick**

The Joystick functions control the resolution of joystick motion, limit motion to a single axis and enable/disable automatic part following when part alignment has been performed.

These joystick functions are not included in part programs, but are typically used by the operator during programming sessions or program execution. Detailed descriptions of the joystick functions are contained in [Chapter 8: Programming](#).

**Motors off**

Checking the Motors Off menu item disables CNC motor operation. Clicking the Motors Off menu item toggles the check mark on and off.

**Capture Image**

Clicking Capture Image creates a bitmap (bmp) file of the current camera image and stores the file in the QC5000\Parts folder using a name that includes time and date information.

The Capture Image function can also be launched by pressing the Control and F8 computer keyboard keys simultaneously.





## Programming functions

Programming functions are used during programming sessions, program execution, for program editing and for program troubleshooting. The programming functions are described in detail in [Chapter 8: Programming](#).

## Setup functions

The Customize, Options and CNC menu items provide access to the supervisor setup functions that are used to configure most operating characteristics of the QC5200 system. The supervisor setup functions are explained in detail in [Chapter 10: Supervisor setup](#).

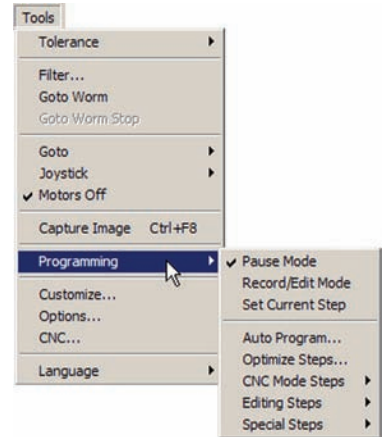
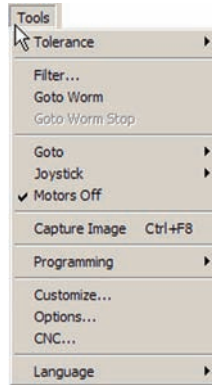

### CAUTION

Changing setup functions may significantly impact the accuracy and reliability of your QC5200 system. These setup functions should be used only by technically qualified supervisors, OEMs and Metronics distributors. If you have questions regarding the setup of your system, please contact your Metronics distributor or the Metronics

technical support group. Contact information is provided in [Chapter 11: Problem solving](#).

## Language

A language for the display of information on the screen, in exported files and on printed reports is specified by clicking the Language menu item and then clicking the desired language.

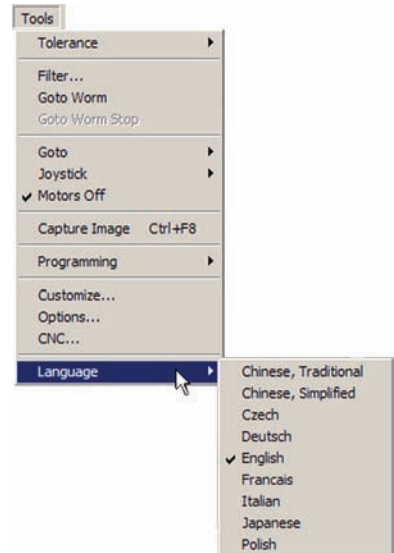

## Windows menu

The Windows menu contains selections for:

- Displaying or hiding the DRO (Digital readout) window
- Displaying or hiding the Part View window
- Displaying or hiding the Results window
- Displaying or hiding the Live Video window
- Creating a new template
- Opening an existing template
- Saving the current templates
- Saving the current template with a new name
- Displaying recently used templates

### Displaying and hiding windows

Check a window name to display the window in the QC5200 workspace. Clear the check mark to hide it.

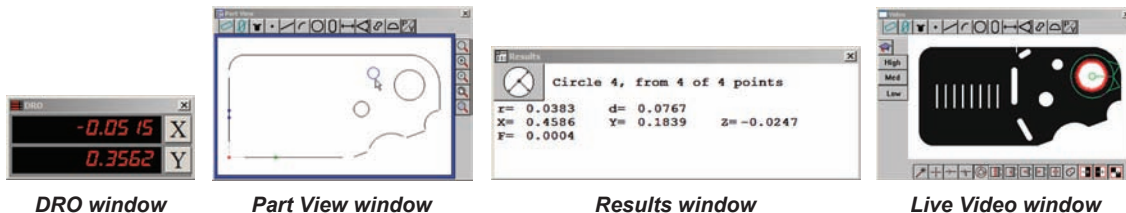
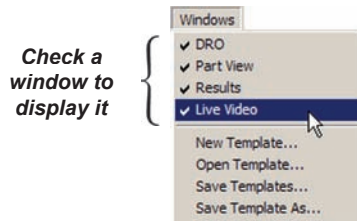

### Creating a new template

Click the New Template menu item to create a new template. The New Template Name dialog box will be displayed.

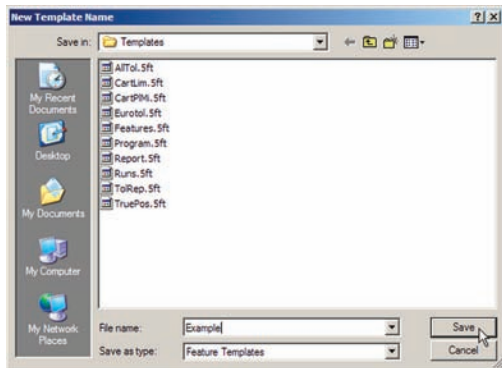
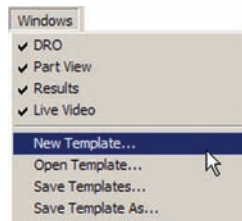

Enter the desired name into the File Name field, then click Save. The New Template type dialog box will be displayed.

Click the desired template type, then click the Use Defaults box to apply all the selected template's defaults to the new template, or clear the box to create a blank template.

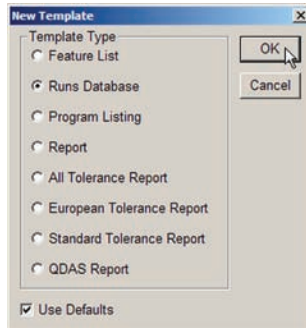

### Opening an existing template

Click the Open Template menu item to open an existing template. The Open Feature Template dialog box will be displayed.

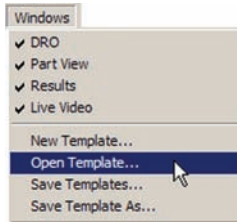

Select the desired template and click Open.

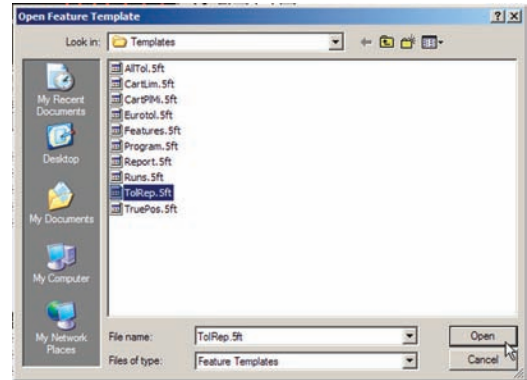

### Saving templates

Templates that have been modified can be saved using the existing file name or a new filename.

#### Save with an existing file name

Click the Save Templates menu item. All current templates will be saved using their existing filenames.

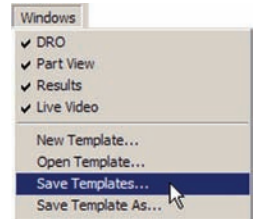

#### Save with a new filename

Click the Save Template As menu item. The Save Feature Template As dialog box will be displayed.

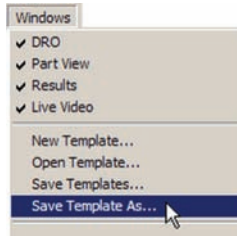

Only the active template will be saved with a new filename.

Enter the desired filename and click Save.

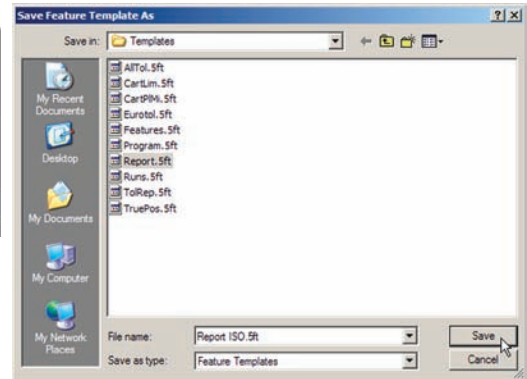

### Displaying recently used templates

Recently used templates are displayed in the lower portion of the Windows menu. Check a template to display it, or clear the check mark to hide it.

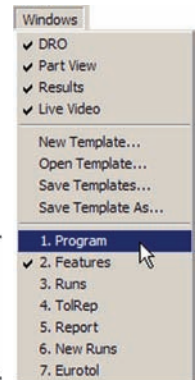

*Check a template name to display it*

## On-screen menus

On-screen menus are displayed by right-clicking different areas of the screen within the QC5200 workspace. The following categories of on-screen menus are available:

- Template window menus
- Results window menus
- Part View window menus
- Live Video window menus
- Toolbar menus

### Template window menus

Template window menus consist of template edit and program edit menus.

### Template edit menus

Template edit menus provide access to standard Windows editing functions, feature editing functions, template functions and chart functions. Template edit menus are displayed by right-clicking a column heading of any template.

A slightly simpler version of the template edit menu can be displayed by right-clicking the title bar of any template except the programming template. This simpler edit menu does not include the Column Properties and Delete Column functions.

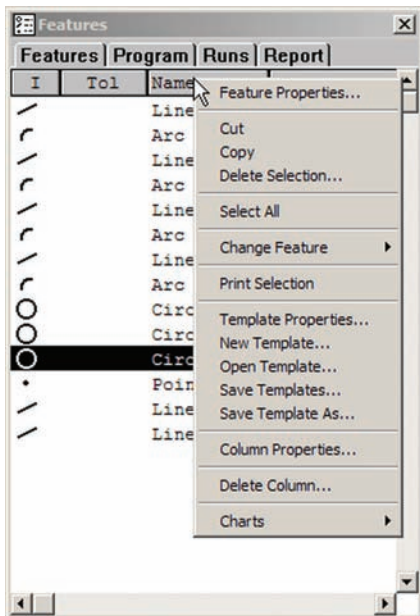

Template menu with column functions

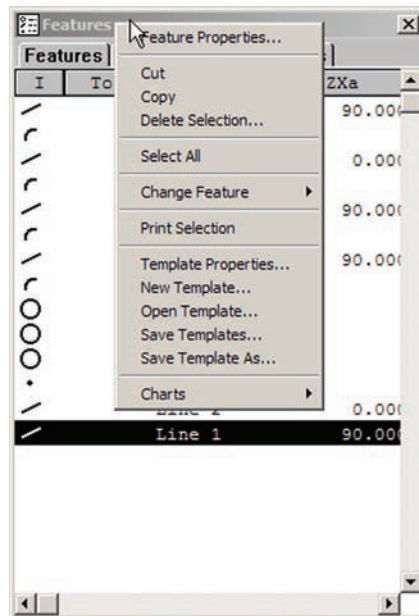

Template menu without column functions

## Common editing functions

The common editing functions include:

- Feature Properties
- Cut
- Copy
- Delete Selection
- Select All
- Change Feature

These first 6 common editing functions are identical to menubar items described earlier in this chapter and are included again in on-screen menus as a convenience for the user.

## Print selection

A feature or collection of features can be selected using standard Windows methods. Selected features are highlighted, and can be printed by clicking the Print Selection menu item.

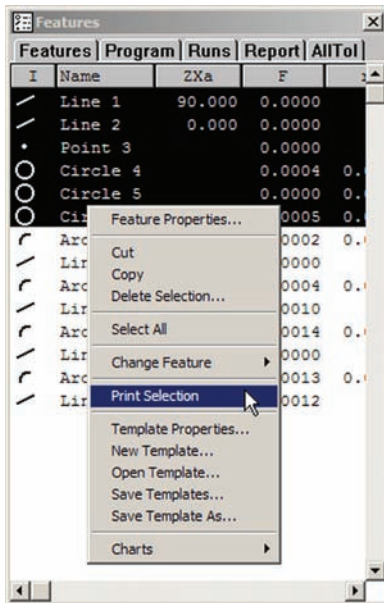

*Clicking Print Selection...*

I	Name	ZXa	F	r	X	Y	Datum
/	Line 1	90.000	0.0000		0.1750	0.0000	Skew
/	Line 2	0.000	0.0000		0.0000	0.1380	
•	Point 3	0.0000	0.0000		0.0000	0.0000	Zero
○	Circle 4	0.0004	0.0383	0.4586	0.1839		
○	Circle 5	0.0000	0.0135	0.3675	0.2155		
○	Circle 6	0.0005	0.0188	0.3370	0.1235		

*prints the selected feature data*

### Template properties

Clicking the Template Properties menu item provides access to tools for specifying parameters for the current template. The Properties tool are slightly different for each template type.

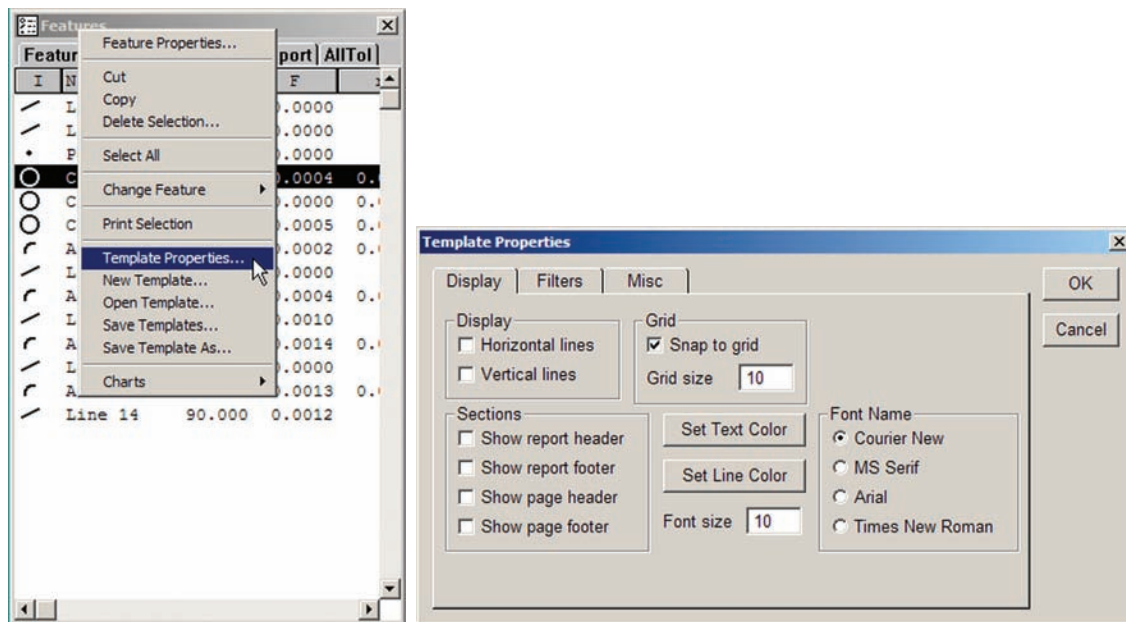

*Clicking Template Properties...*

*displays tools for specifying template parameters*

The template tools are discussed in detail in [Chapter 7: Reporting and Templates](#).

### Template file operations

Template file operations include:

- New Template
- Open Template
- Save Templates
- Save Template As

These menu items are identical to menubar items described earlier in this chapter and are also included in on-screen menus as a convenience for the user.

*Template file operations*

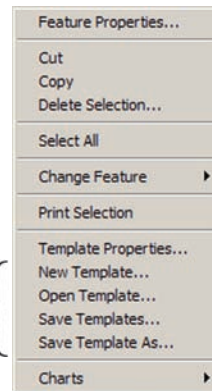

## Charts

Clicking the Charts menu item provides access to charts characterizing the statistical performance of feature data collected by a series of program executions (runs).

The Charts function is discussed in detail in [Chapter 7: Reporting and Templates](#).

## Program edit menus

Program edit menus provide access to standard Windows editing and printing functions, template properties tools, and a wide variety of programming functions. Program edit menus are displayed by right-clicking the title bar or a content line of the Program template.

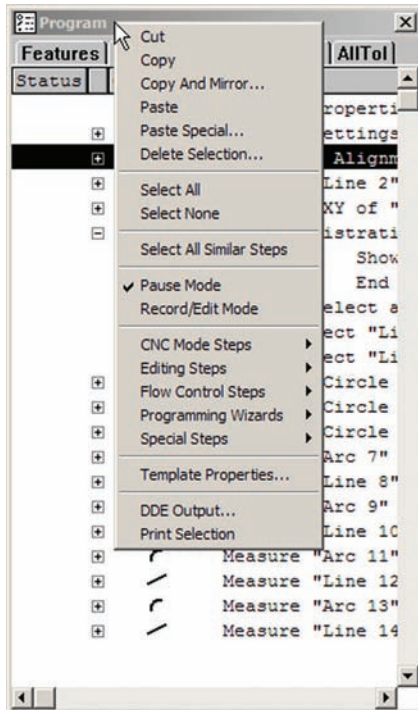
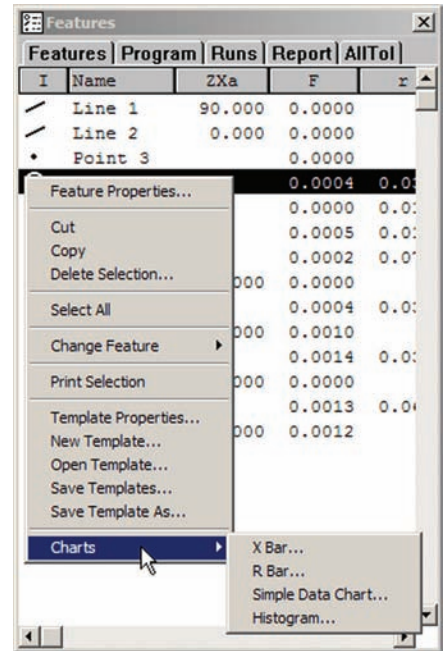

*Right-click the title bar...*

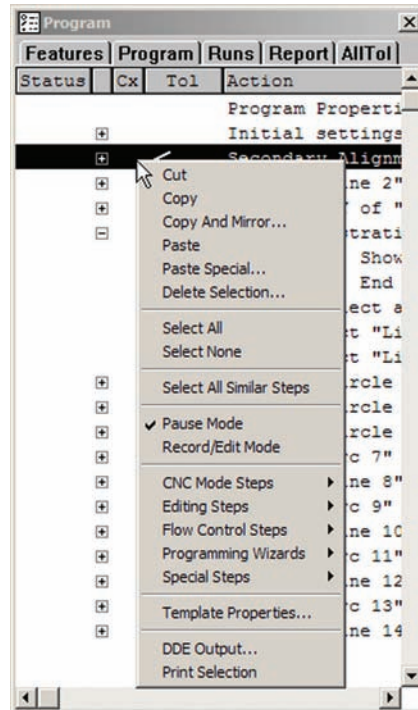

*or contents of the program template*

### Common editing, printing and template functions

The common editing, printing and template functions include:

- Cut
- Copy
- Paste
- Paste Special
- Delete Selection
- Select All
- Select None
- DDE Output
- Print Selection

These menu items are identical to menubar items described earlier in this chapter or are standard Windows functions. They are included in on-screen menus as a convenience for the user

### Programming functions

Programming functions include:

- Copy and mirror
- Select All Similar Steps
- Pause Mode
- Record/Edit Mode
- CNC Mode Steps
- Editing Steps
- Flow Control Steps
- Programming Wizards
- Special Steps

The programming functions are described in detail in [Chapter 8: Programming](#).

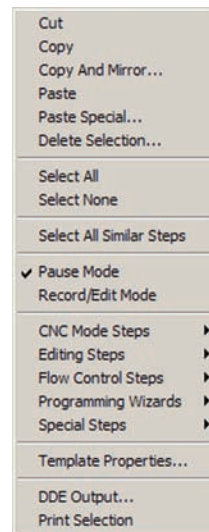



## Results window menus

The Results window menus provide access to tools for:

- Specifying a fit algorithm for the probed data points
- Redefining the feature type (when Measure Magic is used)
- Specifying tolerance parameters
- Exporting feature data using the Microsoft DDE protocol
- Deleting the selected feature
- Specifying feature display and filtration properties
- Formatting the display of the Results window



### NOTE

The contents of the Results window menu changes to support the selected feature type. For example, the menu for a line feature is different than the menu for a circle feature.

Results window menus are displayed by selecting a feature in the Features template or on the Part View window, and then right-clicking anywhere in the Results window.

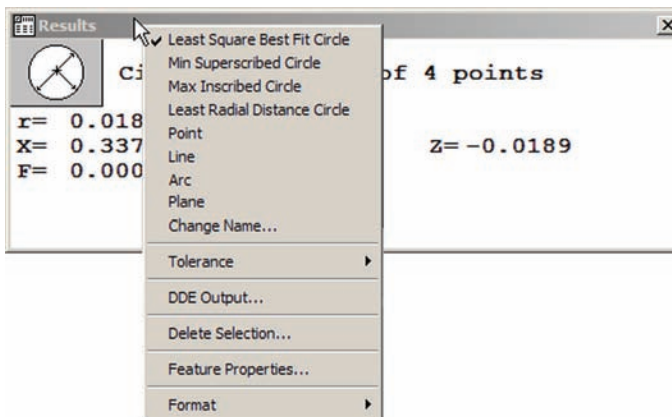

### Specifying a fit algorithm

When more than the minimum required number of points are probed to capture a feature, alternative algorithms can be specified to fit the data.

Click the desired fitting algorithm to re-fit the probed data points.

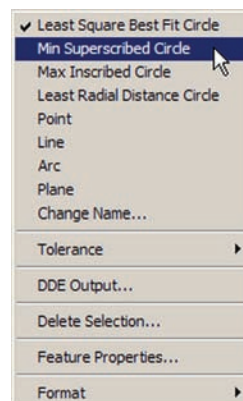

### Redefining the feature type

When Measure Magic is used to capture feature data and the probed data could fit more than one feature type, the wrong feature might be displayed in the Feature template and Results windows.

In this example, a shallow arc is initially classified as a line with poor form (0.0113).

Clicking the Arc feature alternative changes the feature classification to Arc, with a better form (0.0038).

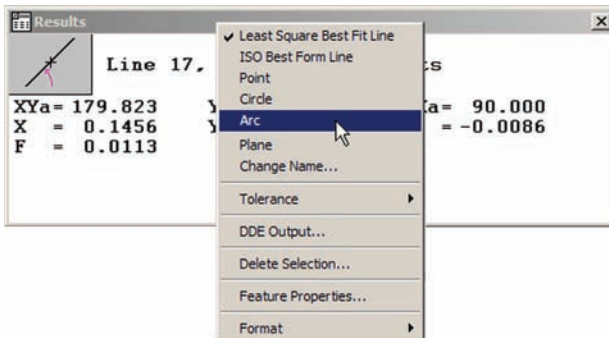

**NOTE**  
Feature alternatives are not provided when a specific measure function is used in place of Measure Magic.

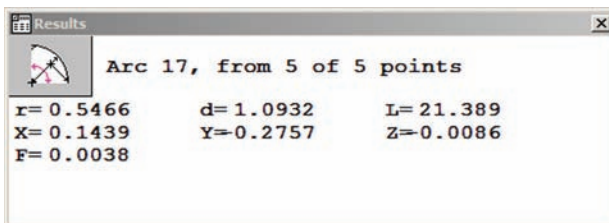

Change the current feature type by clicking the desired feature type in the Results window menu.

### Change name

Feature names can be changed to make feature names consistent with drawing nomenclature or to simplify reporting.

Click the Change Name menu item to display the Change Feature Name dialog box, then enter the desired name and click OK.

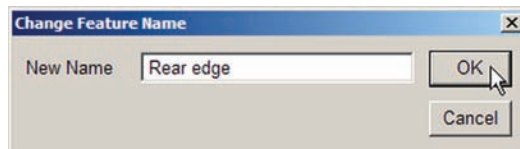
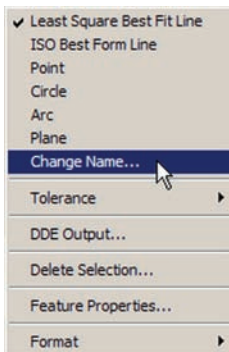

The original feature (type) name will be retained by the system, but the new name will be shown in the Part View window, in templates, in reports and in exported data files.

## Tolerance

The Tolerance menu item provides access to tools for specifying tolerance parameters for the current feature.

The tolerance menu item functions are described in detail in [Chapter 6: Tolerancing](#).

## DDE output

Click the DDE Output menu item to export data for the current feature to an application using Microsoft's DDE protocol.

## Delete selection

Click the Delete Selection menu item to delete the current feature.

## Feature properties

The Feature Properties functions are identical to menubar items described earlier in this chapter and are included in on-screen menus as a convenience for the user.

## Format

The Format menu item provides access to tools for:

- Specifying a narrow or wide window
- Left or right justifying label text
- Specifying text font size
- Editing Results window fields

## Narrow Format/Wide Format

Click the Narrow Format or Wide Format menu item to specify the desired Results window aspect ratio.

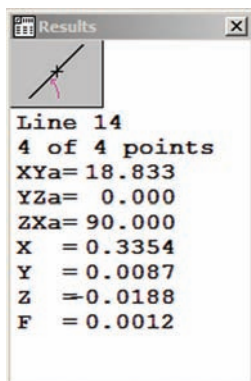
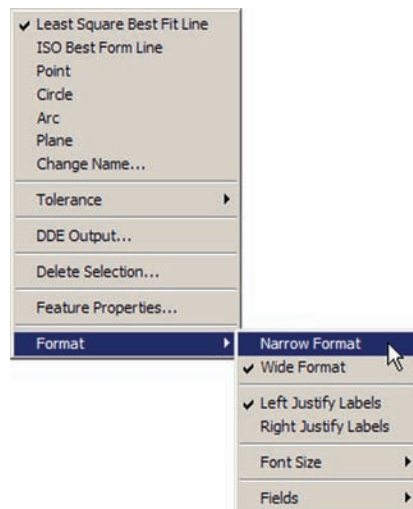
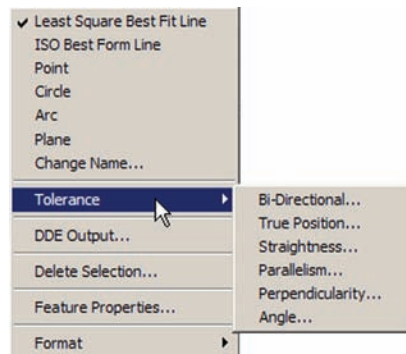

*Narrow format*

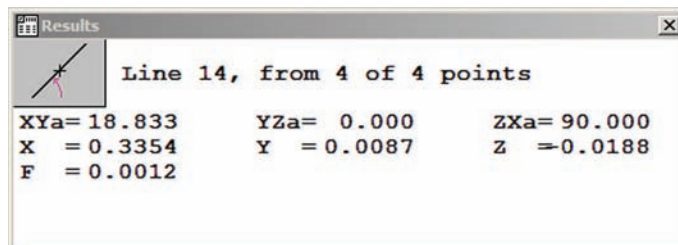

*Wide format*

**Left Justify/Right Justify labels**

Click the Left Justify or Right Justify menu item to specify the desired Results window label text justification.

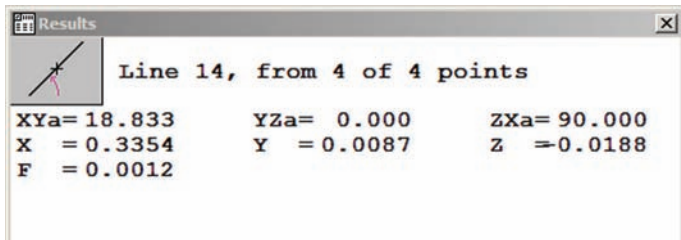

*Left justified*

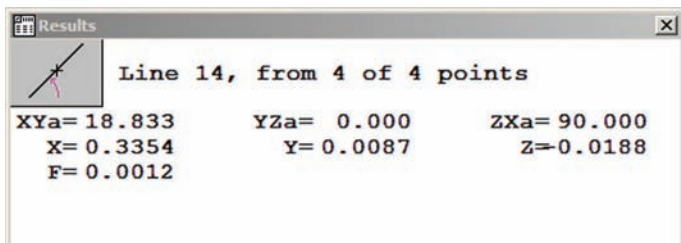

*Right justified*

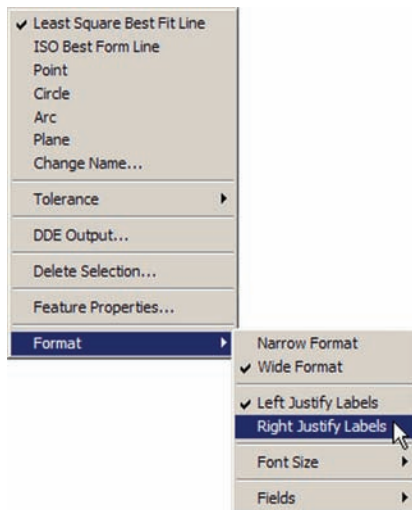

**Font size**

Click the Font Size menu item to choose a specific point size for all text in the Results window, or click Auto Size to allow the QC5200 to determine the optimum font size.

**Fields**

The Fields menu item provides access to advanced formula and field editing tools that are reserved for qualified special application developers.

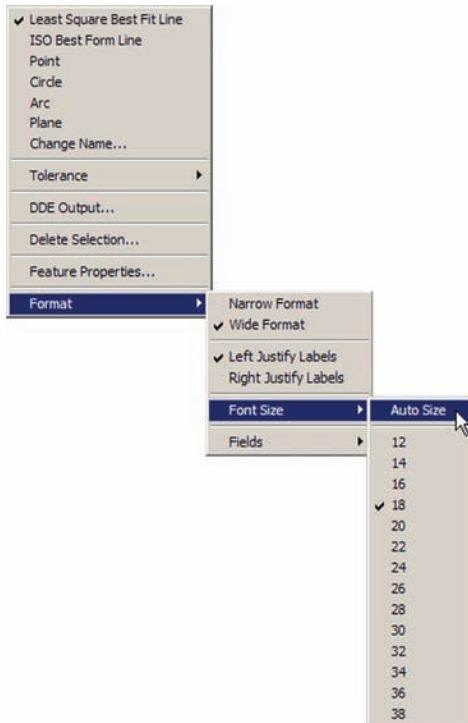

## Part View window menus

The Part View window menus provide access to tools for:

- Zooming in or out to show Part View window contents at different magnifications
- Printing the contents of the Part View window
- Deleting selected features
- Selecting all features
- Specifying feature properties

### Zoom functions

The Zoom All, Zoom Window and Zoom Special functions are identical to menubar items described earlier in this chapter and are included in on-screen menus as a convenience for the user.

### Print part View

Click Print Part View to display the Enter Report Header Data dialog box.

Enter the desired header information and click OK. The contents of the Part View window will be printed in the format determined by the current Page Setup and printer settings.

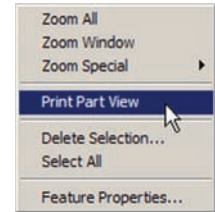
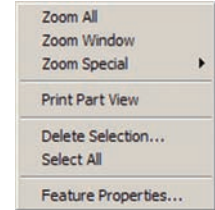

### Delete selection

Click the Delete Selection menu item to remove the highlighted feature(s).

### Select all

Click Select All to select all features.

### Feature properties

The Feature Properties functions are identical to menubar items described earlier this chapter and are included in on-screen menus as a convenience for the user.

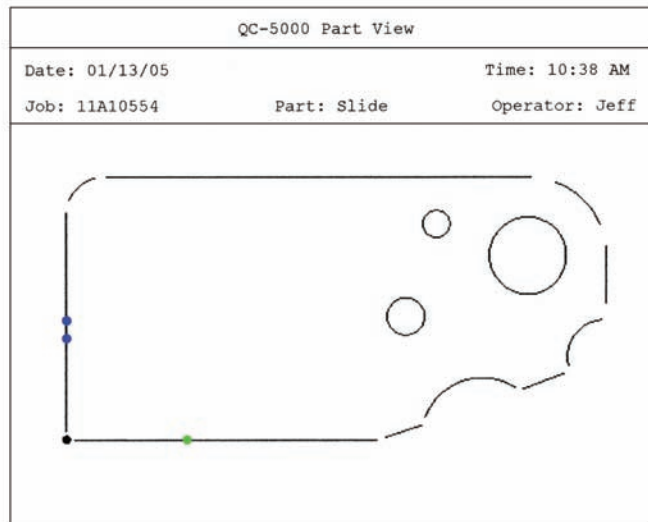

*Part View printout*

## Live Video window menus

The Live Video window menus provide access to tools for:

- Firing the current video probe
- Selecting the New VED probe
- Selecting a VED probe
- Teaching (calibrating) video edge detection
- Filtering camera images to improve video edge recognition
- Sending the stage to the beginning (Goto Worm) or the end (Goto Worm Stop) of the worm probe travel
- Capturing a bitmap of the current camera image
- Automatically finishing a feature measurement (Auto Finish) after a video tool is fired
- Selecting the High Accuracy mode for data acquisition
- Selecting the Continuous Fire mode for probe positioning
- Entering or removing data points and completing or cancelling a measurement

Most Live Video window menu items pertain to video probe calibration or use in measurements and are described in detail in [Chapter 4: Probes](#) and [Chapter 5: Measuring](#).

### Dry fire probe

During a probe setup process, when Measure Magic is not used, click Dry Fire Probe to indicate data points that will be collected during actual measurements. During a measurement session, when Measure Magic is used, clicking Dry Fire Probe collects feature data.

### New VED Probe

Click New VED Probe to select the New VED Probe for a measurement.

### VED Probes

Click VED Probes to select a probe from the list of VED probes. Click Load Video Chart to import a dxf overlay file as a basis of qualitative visual part inspections.

### Teach VED Edge

Click Teach VED Edge to calibrate VED edge detection. Follow instructions presented on the screen. Details are provided in [Chapter 4: Probes](#).

### Filter

Click Filter to launch an image processing utility that can be used to optimize the camera image for video edge detection. Follow instructions presented on the screen. Details are provided in [Chapter 4: Probes](#).

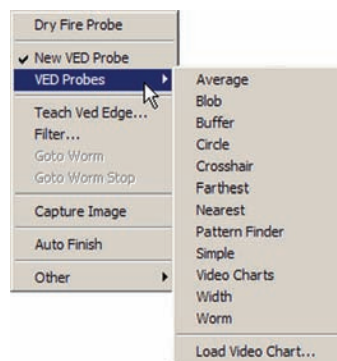
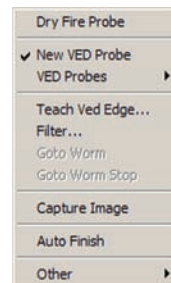

### Goto Worm/Goto Worm Stop

Click Goto Worm or Goto Worm Stop to send the stage to the beginning or end of the Worm probe path during a measurement session using the Worm probe. Details are provided in [Chapter 4: Probes](#).

### Capture Image

Click Capture Image to capture the current camera image as a bmp file in the QC5000\Parts folder. The file will be given a name that includes the time and date of the capture operation.

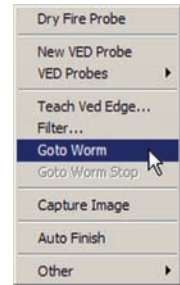

### Auto Finish

Click auto Finish to toggle the Auto Finish function on or off. When Auto Finish is enabled, a feature measurement will be completed when a video probe is fired.

### Other/High Accuracy

Click High Accuracy to toggle the High Accuracy measurement mode on or off. When the High Accuracy mode is enabled, three sets of data will be collected and averaged when a probe is fired. The average will be returned as feature data.



### Other/Continuous

Click Continuous to continuously fire the active video probe for probe performance evaluations. Data will not be collected until the probe is fired by the operator, but data points will be displayed at the probe continuously.

The Live Video window menu changes slightly during a measurement to the include measurement functions Enter Pt, Remove Last, OK and Cancel.

### Enter Pt

Click Enter Pt to acquire a data point or data points by firing the current probe.

### Remove Last

Click Remove Last to remove the last acquired point from the current collection of data points.

### OK

Click OK to complete the current measurement and send acquired data to the Feature list.

### Cancel

Click Cancel to cancel the current feature measurement.

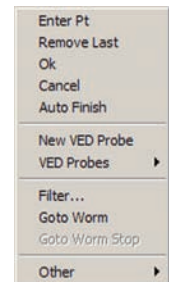

## Toolbar menus

Toolbar menus are identical for all toolbars and are displayed by right-clicking on a toolbar.

Toolbar menus provide access to functions for:

- Displaying or hiding toolbars
- Customizing toolbar content
- Changing toolbar appearance

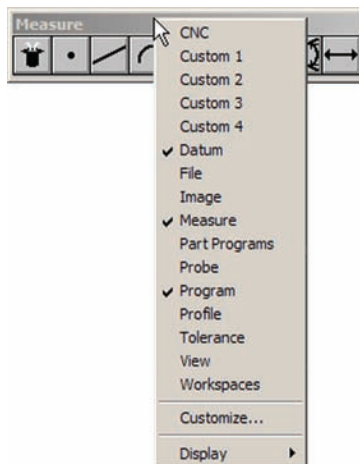

### Displaying or hiding toolbars

Check a toolbar title to display the toolbar. Clicking a title toggles the check mark on or off.

### Customize

Click the Customize menu item to display the Customize Toolbars dialog box. The customize toolbar functions are described in detail in [Chapter 10: Supervisor Setup](#).

### Display

Clicking the Display menu item provides access to tools for changing the toolbar icon size and toolbar title.

### Toolbar icon size

Click Normal, Large or Huge to specify the toolbar icon size as preferred.

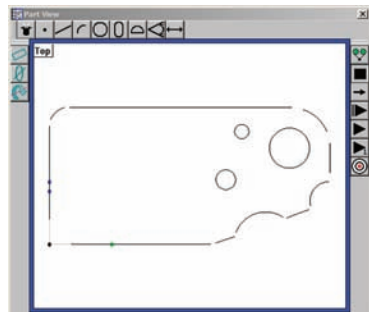
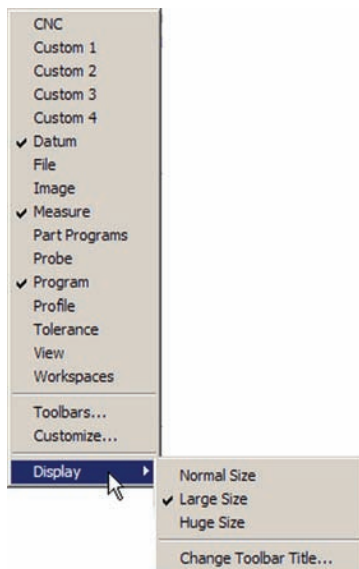

Normal icon size

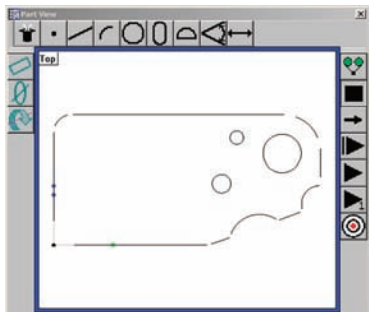

Large icon size

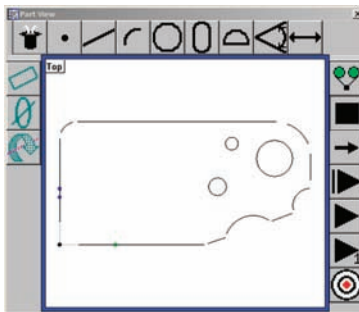

Huge icon size



**Change toolbar title**

Click the Change Toolbar Title menu item to display the Change Toolbar Title dialog box.

Enter the desired toolbar title and click OK. The new title will be displayed immediately in the toolbar.

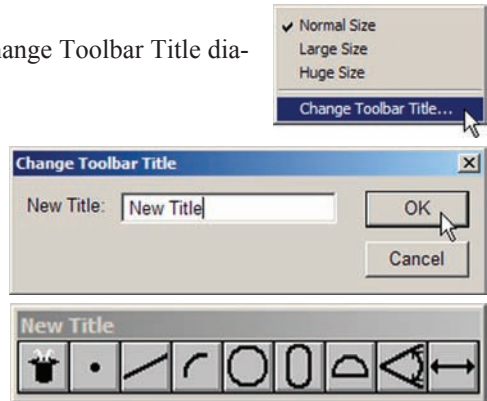

# Toolbars

Toolbars contain icon buttons that provide quick access to commonly used functions. Nearly all toolbar functions are also available in menubar or in on-screen menus. Clicking a toolbar button initiates the function.

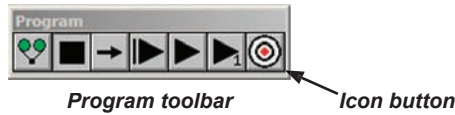

Click the View/Toolbars menu item to display the Toolbars dialog box. Highlight the desired toolbar title, and then click Show to display it, or click Hide to hide it.

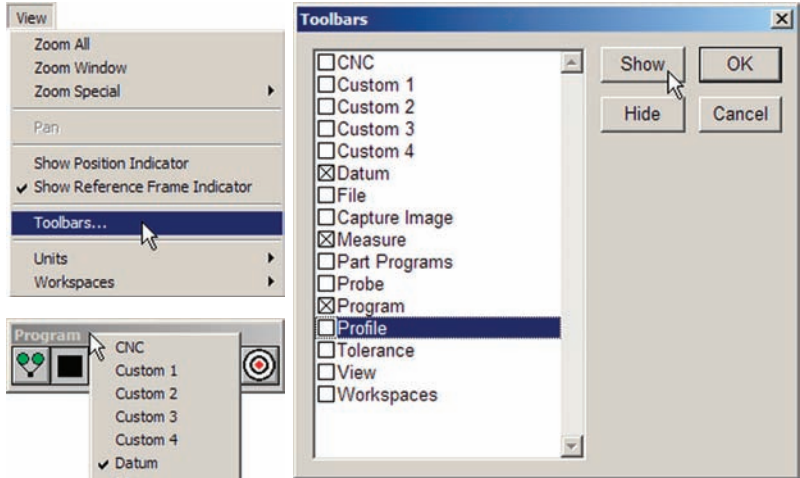

Toolbars can also be displayed or hidden by right-clicking the toolbar. The list of available toolbars will be displayed. Check a toolbar title to display it, or clear the toolbar check mark to hide it. Clicking the toolbar title toggles the check mark on and off.

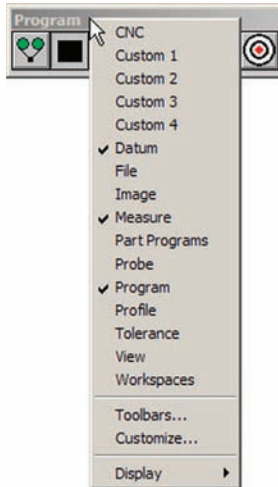

Toolbar icon functions are shown in tool tips when the mouse cursor hovers over an icon. The tool tip function is enabled in the Tools/Customize/Help screen.



## Changing toolbar shape

Toolbars can be displayed as horizontal or vertical bars, or as blocks. The shape of a toolbar can be changed by clicking and dragging a corner.

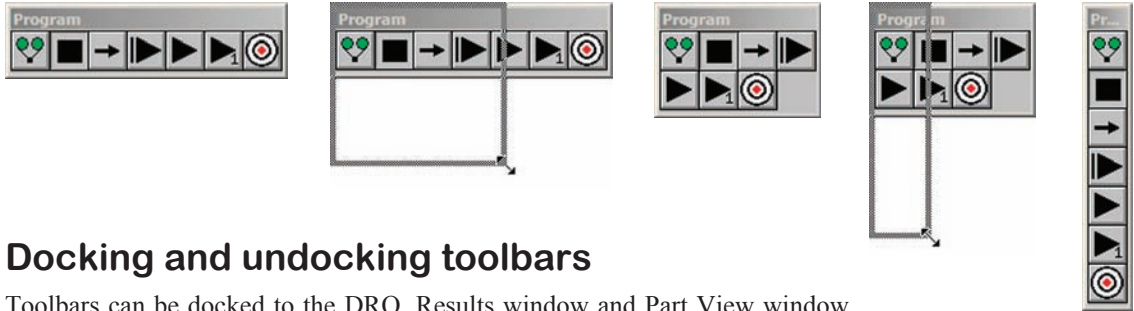

## Docking and undocking toolbars

Toolbars can be docked to the DRO, Results window and Part View window to conserve screen space and organize the workspace to suit the preferences of individual users.

To dock a toolbar, click and drag the desired toolbar to the edge of the target window, and then release the mouse. An edge of the toolbar should slightly overlap the inner perimeter of the target window as shown here.

When a toolbar is docked, its title bar is replaced with two parallel lines.

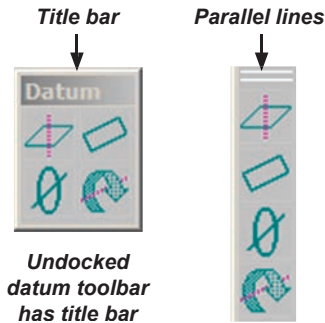

*Docked datum toolbar has parallel lines*

*Overlap*

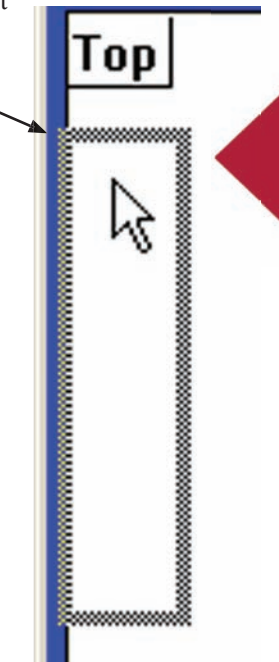

*The left edge of the toolbar overlaps the perimeter of the Part View window*

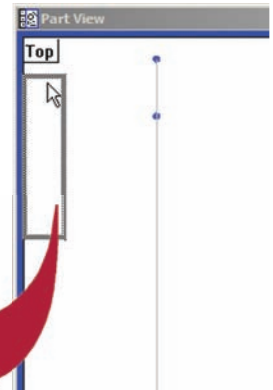

*The Datum toolbar is docked to the Part View window*

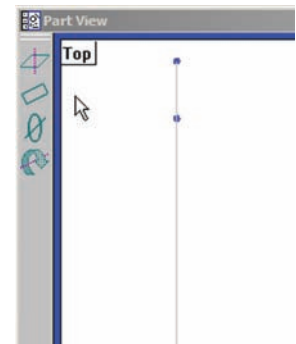

*When a toolbar is docked, its title bar is replaced with two parallel lines*

To undock a toolbar, click on the toolbar's parallel lines. The toolbar will separate from its docked position. Then click and drag the toolbar to a new location.

## Customizing and creating toolbars

Toolbars can be customized by the user to better support specific application requirements. New custom toolbars can be created that include any collection of function icons. Toolbar customizing and creation is described in detail in [Chapter 10: Supervisor Setup](#).

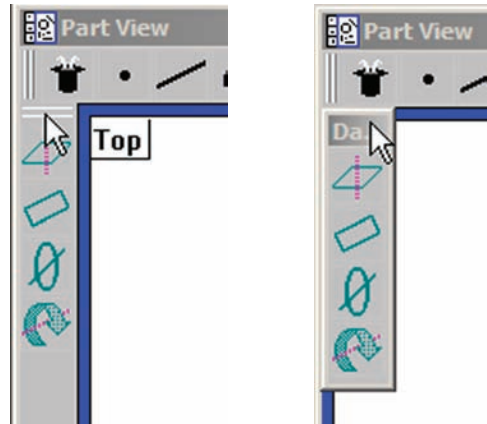

*Click on the parallel lines to undock the toolbar*

## Statusbar

The statusbar presents information regarding measurement, program and other QC5200 status. Status information fields can include:

- Date
- Coordinate system (Cartesian or polar)
- Units of measure (English or metric)
- Current probe magnification
- Angular display units (degrees, minutes, seconds or digital degrees)
- Error correction enabled
- Program status
- Fine position enabled
- Temperature compensation status



Click the Tools/Customize/Statusbar menu item to display the Statusbar dialog box. Highlight the desired status information, and then click Show to display it or click Hide to hide it.

The Statusbar is also used to display descriptions of functions. When the mouse cursor hovers over a menu item, the Statusbar changes to provide a brief description of the menu item function.

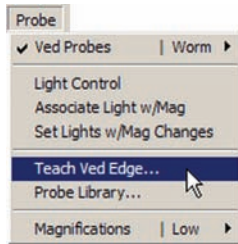

*When the cursor hovers over a menu item...*

**Teach the current probe**

*the Statusbar displays a description of the function*

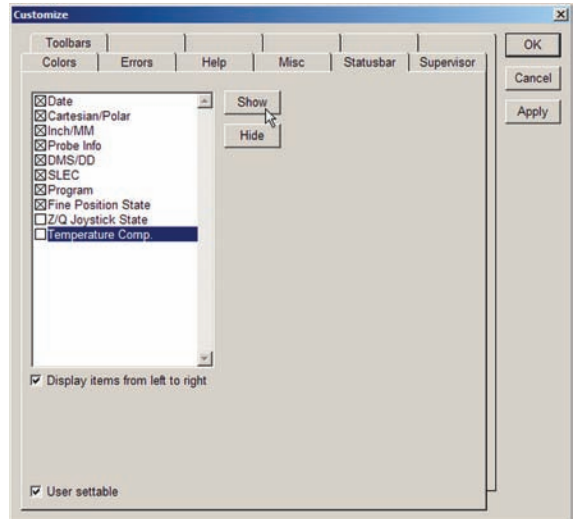

The statusbar can be displayed from left to right, or from right to left. Check or clear the Display items... box of the Tools/Customize/Statusbar screen as desired.

# Workspaces

QC5200 workspaces contain all elements of the user interface organized to satisfy the needs and preferences of individual users.

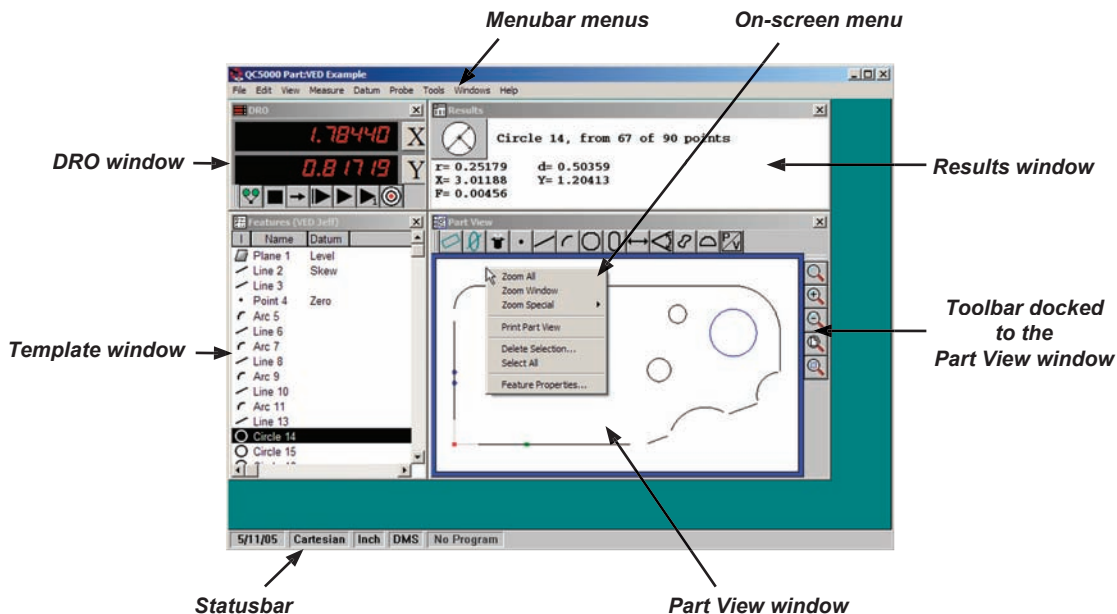

## Creating custom workspaces

Custom workspaces can be created by using the tools discussed earlier in this chapter to customize the shapes, content and locations of Windows, templates and toolbars. The two screens shown on this page contain the same part data but have customized to show it differently, illustrating the flexibility of custom workspaces.

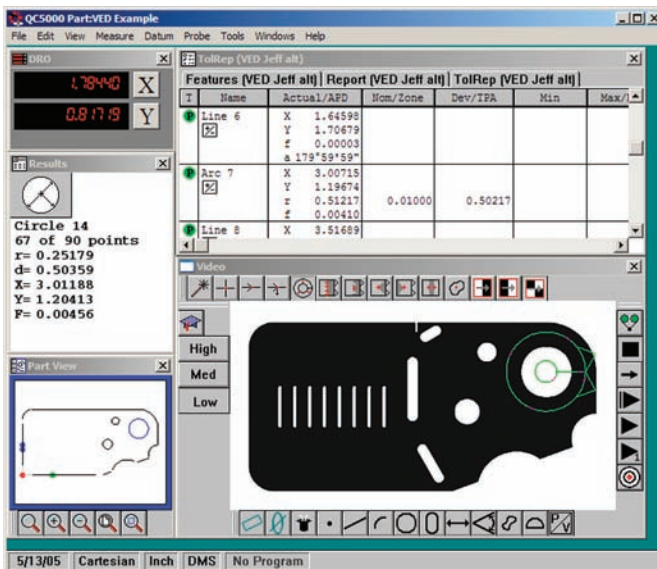

## Saving custom workspaces

Workspaces are stored in the Workspaces folder of the QC5000 directory using a .5ws file extension. To save a workspace, click the View/Workspaces menu item and then click Save Workspace as. The Save Workspaces as file dialog box will be displayed. Enter the desired name and click Save.

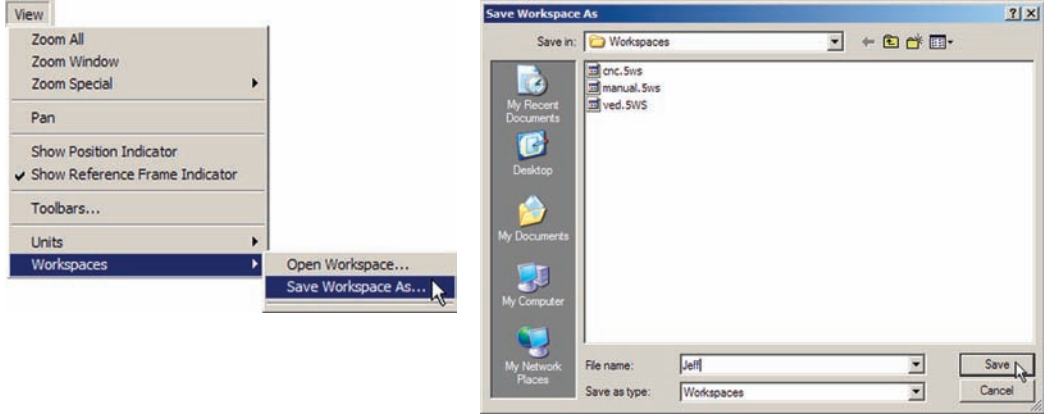

When saved, the workspace name will be shown on the template tabs and in the View/Workspaces list of available workspaces.

## Opening custom workspaces

Custom workspaces can be opened to restore the user interface to an organization of Windows, toolbars and templates developed at an earlier time. To open a custom workspace, click the View/Workspaces menu item to display the list of available workspaces, and then click the desired workspace name.

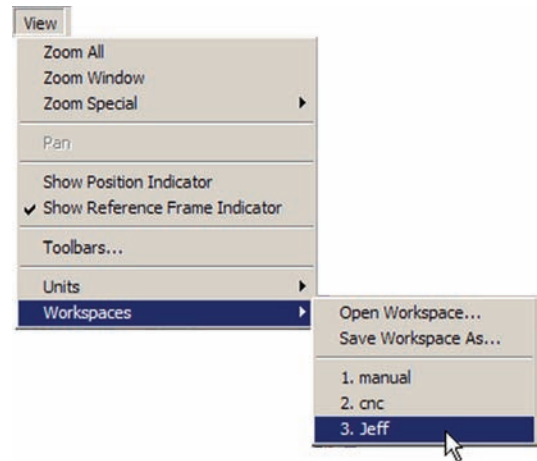

## Launching the QC5200 program into a specific workspace

When multiple operators use the same QC5200 system and prefer different workspace layouts, it is convenient to provide each operator with a unique desktop shortcut that launches the QC5200 program directly into a specified workspace.

To create a custom desktop shortcut:

- 1 Right-click the QC5000 desktop shortcut icon, and then click Properties. The Properties dialog box will be displayed.
- 2 Append the following information to the command line in the Target data field:

space, path to specific workspace file in the workspaces folder

for example, to launch directly into a workspace previously saved as *Jeff*, the revised command line would be:

C:\QC5000\QC5000.exe C:\QC5000\workspaces\Jeff.WS5

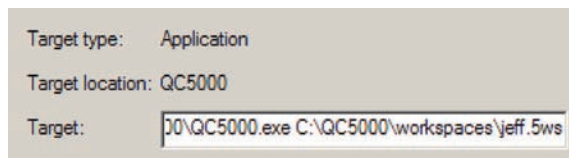

- 3 Click OK to save the new command line.
- 4 Right-click the QC5000 desktop shortcut icon, and then click Rename. Enter a unique name for the desktop shortcut icon and then click the keyboard Enter key.



Double-clicking the shortcut will now launch the QC5200 directly into the specified workspace. The workspace name will be shown on templates.

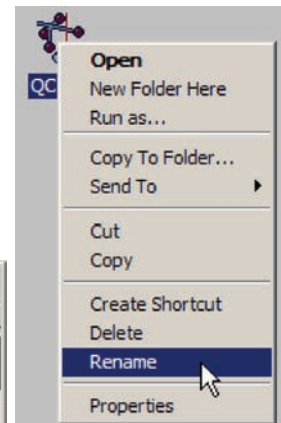
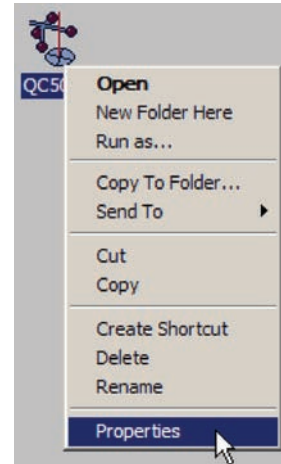
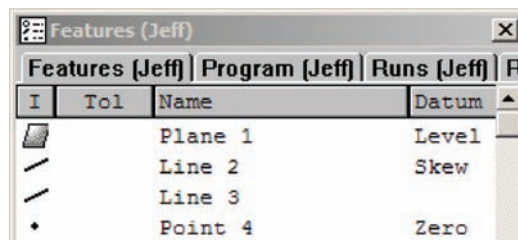



# Chapter 3:

## Quick Start Demonstration

This chapter demonstrates the operation of the QC5200 system. The demonstration is provided as a means of quickly getting experienced operators started using the system. This material will be most helpful if you perform the measurements and other activities as you follow along with this demonstration.

The demonstration will measure the Metronics QC Quickie slide part skew and datum, measure some part features, apply a few tolerances, export results data as a comma separated variable (csv) file and print a tolerance report. These activities will be recorded as a program and saved as a part file.



*The QC Quickie slide is shipped with each system*

Measurements will be performed on a video stage using video edge detection, but could also be performed on a video microscope. When the program is run on a CNC system using temporary fixturing, the user will measure the datum of the first part, and then all subsequent measurements will be completed by the system as the stage is repeatedly positioned and the required points are automatically probed. When the program is run on a manual system, the series of required points will be indicated by a blinking green dot that moves over the part outline in the Part View window. The user need only probe locations indicated by the dot to complete measurements.

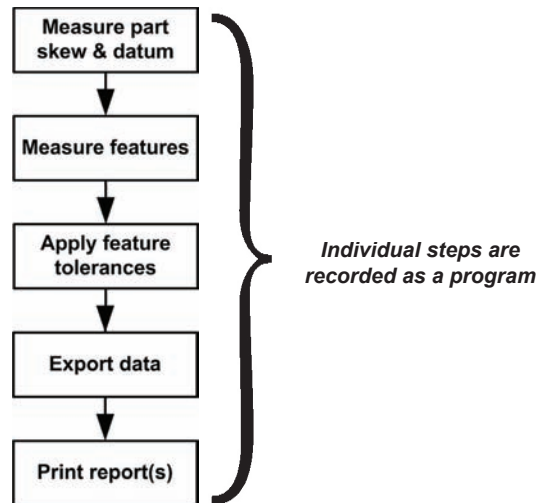

*Summary diagram of the Quick Start Demonstration*

Detailed information regarding measuring is contained in [Chapter 5: Measuring](#). Detailed information regarding programming is contained in [Chapter 8: Programming](#).

## Demonstration steps

This diagram shows the individual steps of the quick start demonstration. References are provided on the diagram and throughout the demonstration to more detailed information in this guide regarding each step.

Measure Magic will be used throughout this demonstration so that video probes can be fired on feature edges without the need to first identify the feature type. Refer to [Chapter 5: Measuring](#) for details regarding Measure Magic.

*Individual steps are recorded as a program*

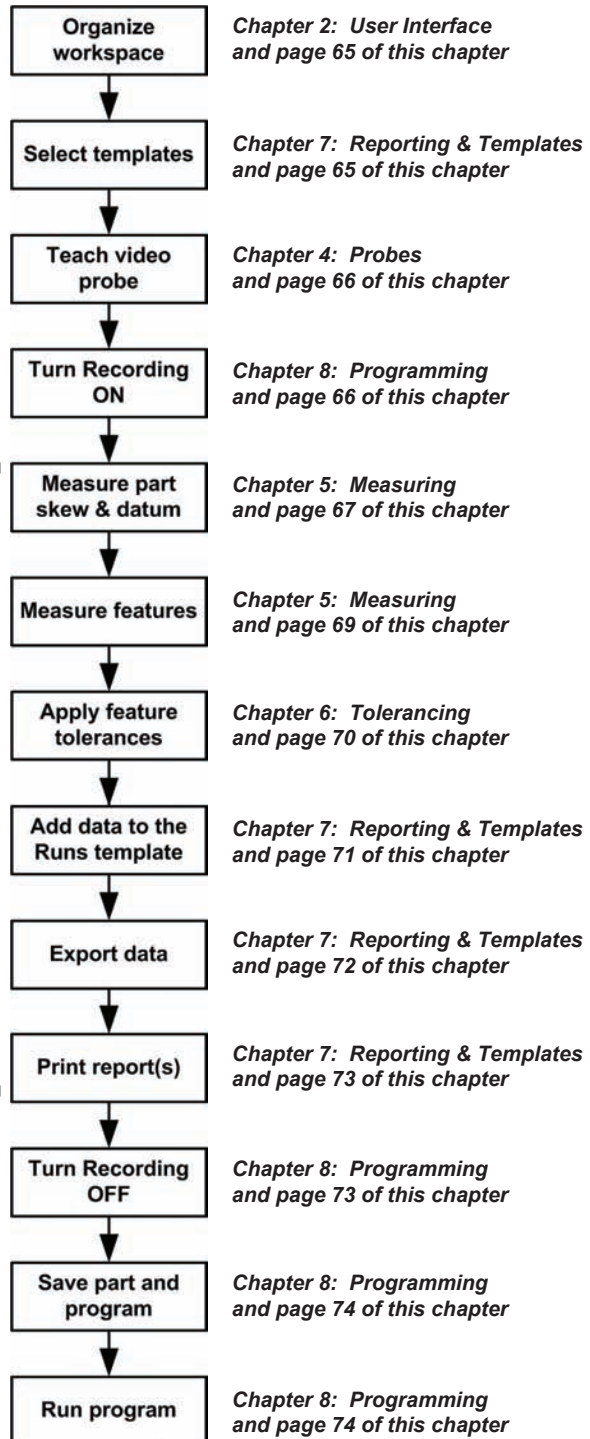

## Organizing the workspace

A detailed description of the user interface and methods of organizing, saving and opening workspaces is provided by [Chapter 2: User Interface](#). The workspace components for this demonstration include the:

- DRO
- Features template
- Measure toolbar
- Probe toolbar
- Results window
- Program template
- VED toolbar
- Part View window
- Runs template
- Program toolbar
- Live Video window
- TolRep template
- Datum toolbar

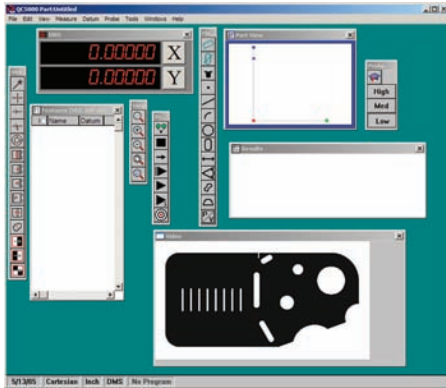

Workspace windows and toolbars...

A single monitor is used in this demonstration. The Windows should be resized and relocated to optimize viewing.

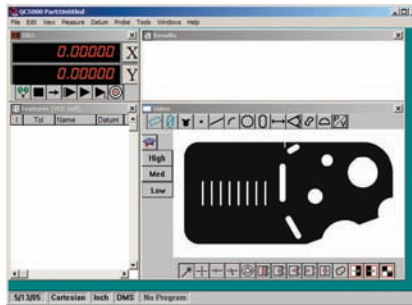

are organized to optimize viewing

Toolbars should be docked to conserve screen space. The Part View and Live Video windows are also stacked to conserve space and are toggled using the P/V toolbar button.

3 Quick Start Demonstration

## Selecting templates

A detailed description of templates is provided by [Chapter 7: Reporting and Templates](#). The Runs and TolRep (Tolerance Report) templates will be stacked on the Features and Program templates to facilitate data collection in the Runs database and tolerance reporting.

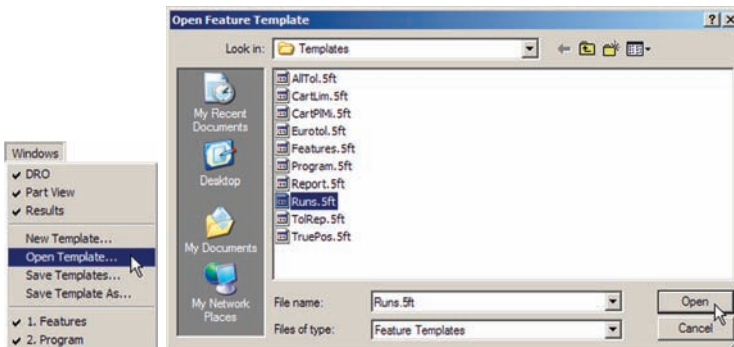

Open the Runs and TolRep templates...

Program			
Features	Program		
Status	Cx	Tol	Action

TolRep			
Features	Program	Runs	TolRep
T	Name	Actual/APD	Nom/Zone

to add them to the Template window

## Teaching the video probe

A detailed description of video probes is provided by [Chapter 4: Probes](#). Video edge detection must be taught (calibrated) to optimize recognition of the contrast between dark and light levels prior to measurements. Click the Probe/Teach Video Edge menu item to teach the probe.

You will be instructed to move the Simple probe over an edge and press OK. You will also be given the opportunity to select the type of edge detection algorithm. Click Auto if it is not already selected, then click OK.

Position the simple probe over an edge oriented to detect in the light to dark direction, and then fire the probe. The acquired data point will be shown by a red cross at the edge and you will be notified that a point was acquired by the Simple probe. Click OK to conclude the calibration.

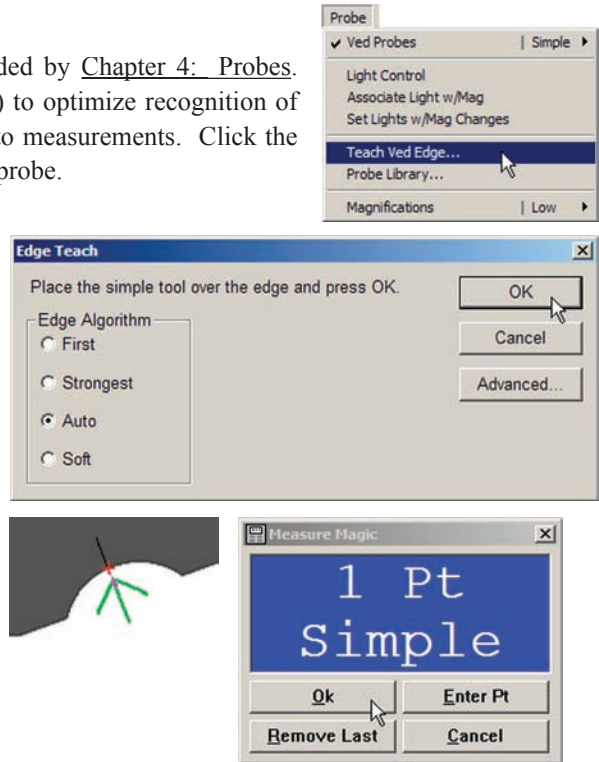

## Turning program recording ON

A detailed description of programming is provided by [Chapter 8: Programming](#). Click the Record/Edit Program toolbar button to begin recording your measurement activities as a program.



## Measuring part skew and datum

Detailed descriptions of measuring the part skew and datum are provided in [Chapter 5: Measuring](#).

### Skew

The part skew must be measured to eliminate errors resulting from part misalignment. Use the Buffer probe to measure the bottom edge.

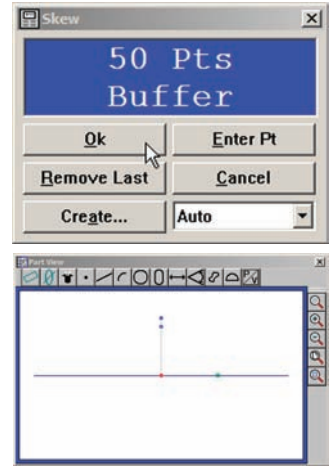
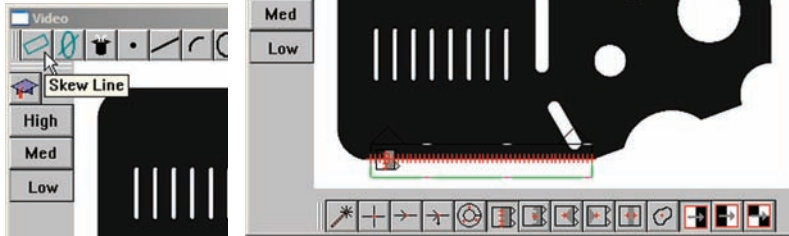

Click the Skew Line toolbar button, measure the skew line and click OK to complete the measurement

### Datum

A part datum point must be established as a reference for subsequent measurements. In this example, it will be constructed at the intersection of the skew line and the vertical line measured along the left edge of the part.

Use the buffer probe to measure the left vertical edge.

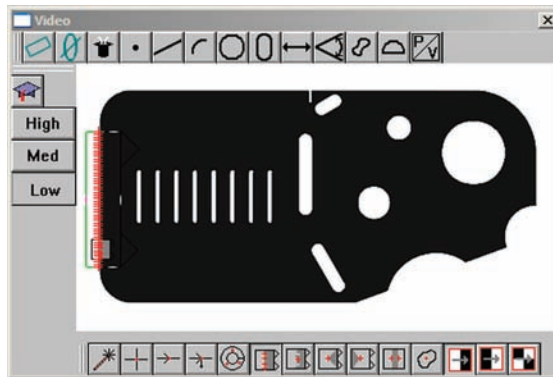

Construct the datum point from the intersection of the skew line and the left part vertical line.

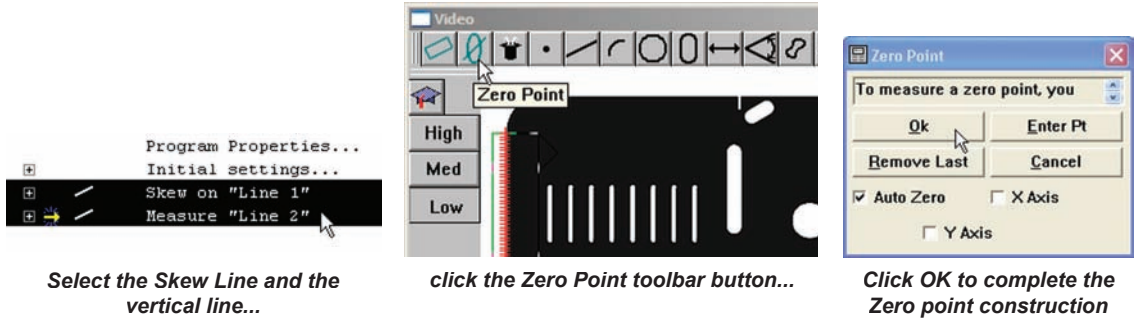

You will be asked to confirm that your reference frame is complete. Click Yes. The program will include the datum and record the part registration.

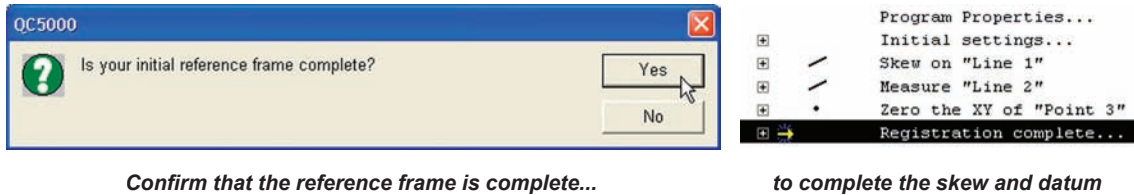

The reference frame will be shown in the Part View window, and subsequent measurements will be referred to the new datum.

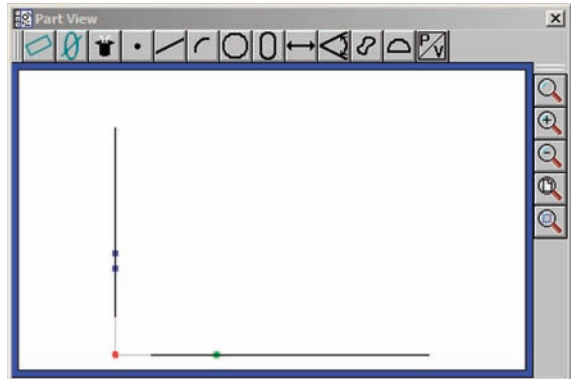

## Measuring features

In this example, the perimeter and the three holes of the QC Quickie slide will be measured using the Buffer, New and Circle probes and Measure Magic. A detailed description of measuring features is provided by [Chapter 5: Measuring](#).



Measure the perimeter starting with the arc in the top left corner of the part. In this example the New probe is used to click and drag a probe and measure the arc.

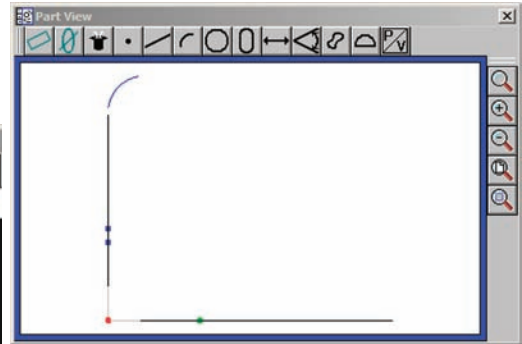
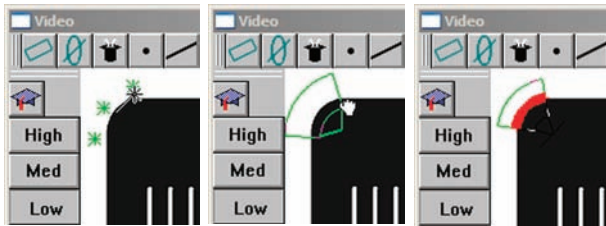

*Click, drag and fire the New probe to measure the top-left arc feature*

Continue measuring perimeter features in a clockwise direction using the Buffer and New probes until the entire slide perimeter is measured, and then measure the three holes using the Circle probe.

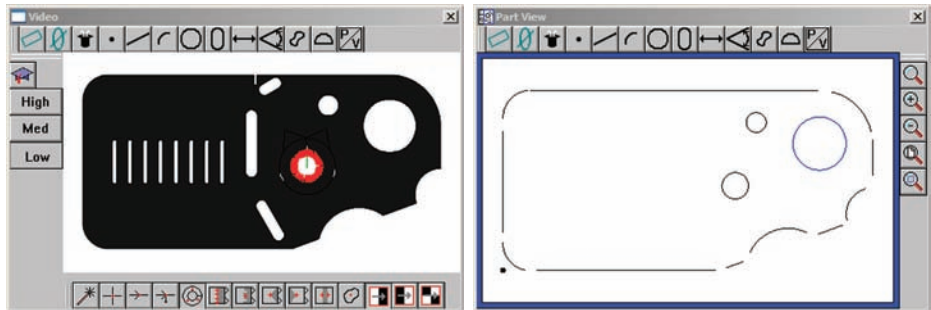

The final measurement steps are shown in the Program template window.

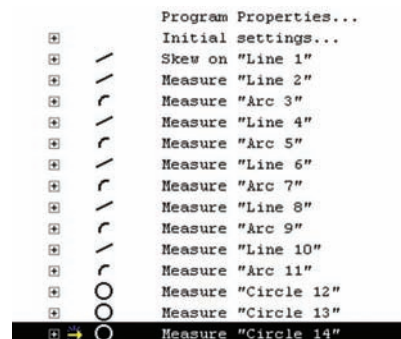

3 Quick Start Demonstration

## Applying feature tolerances

A detailed description of applying tolerances to features is provided by [Chapter 6: Tolerancing](#). Circularity tolerances will be applied to the three circles. The tolerance result data will be collected automatically by the TolRep (Tolerance Report) template, and will be printed later.

Select the features and then select the tolerance type.



Select the three circles and then right-click the Results window and select the tolerance type

Enter the tolerance data into the Tolerance Entry dialog box and click OK. The tolerance results will be displayed in the Tolerance Results dialog box and in the feature lists. Click OK to complete applying tolerances.

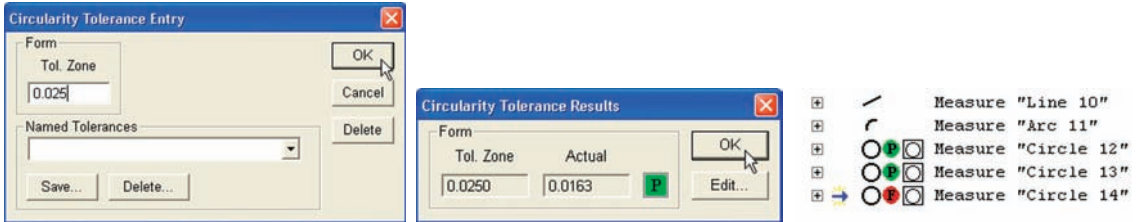

Enter the tolerance data...

to display tolerance results in the Tolerance Results dialog box and in feature lists



## Adding data to the Runs template

A detailed description of the Runs template is provided by [Chapter 7: Reporting and Templates](#). The Runs template will be used to collect user-specified measurement result data in the Runs database. In this example, measurement results for the three circles will be collected by the Runs template. The contents of the Runs template will be exported later as a .csv file.

Each part should have a unique Runs template and associated database. The Runs template can be made unique by saving it using a unique template name. Change the name of the default Runs template for the current part. Select the Runs template as the active template, right-click the template, click Save Template As, enter the new unique template name and Click Save.

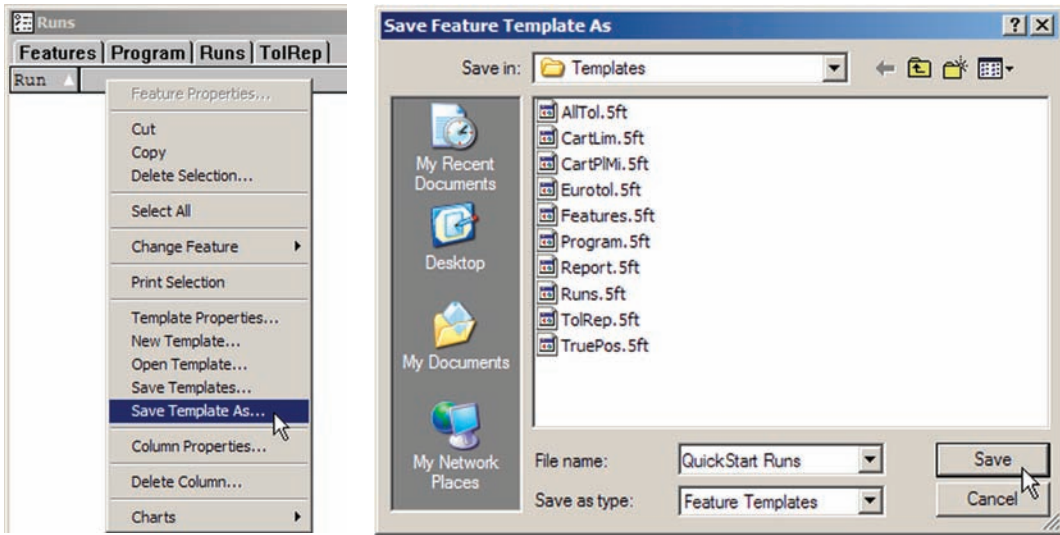

**Make the Runs template active and save it using a name unique to this part**

The desired feature measurement results must be loaded into the renamed Runs template. Select the Features or Program template as the active template then select the desired features. Select the renamed Runs template as the active template, select the desired feature parameters in the Results window and drag and drop them from the Results window into the Runs template.

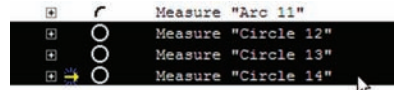

**Select the desired features**

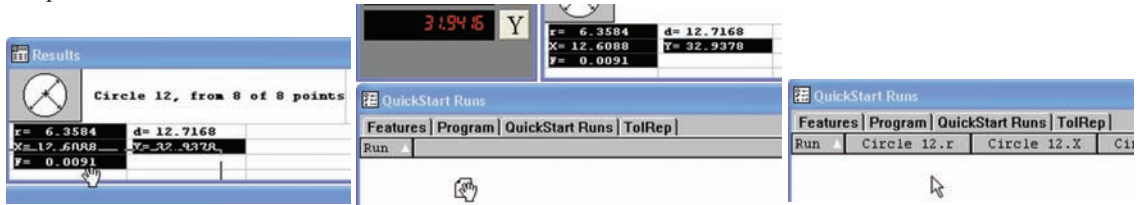

**Select the desired results...**

**then drag and drop them...**

**into the Runs template as columns**

## Exporting data

A detailed description of exporting data is provided by [Chapter 7: Reporting and Templates](#). Data can be exported from templates in a variety of file formats. This example will export the measurement result data previously loaded into the Runs template as a comma separated variable (.csv) file.

Select the Runs template as the active template, select the data to be exported, click File/Export, enter the desired export file name into the Export dialog box, select the export file type and click Save.

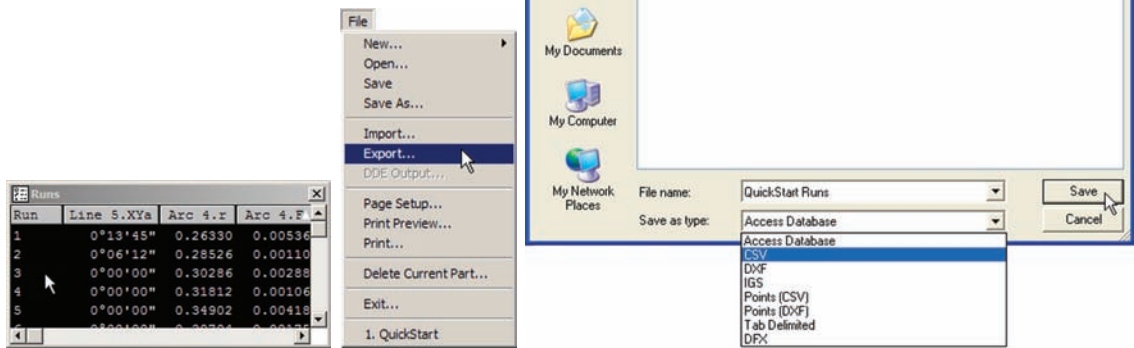

Select the template and data...

click Export...

enter an export file name, select the file type and click Save

## Printing reports

A detailed description of printing reports is provided by [Chapter 7: Reporting and Templates](#). Reports can be printed from any template. This example will print the tolerance results for the three hole measurements of the slide.

Select the TolRep template as the active template, select the desired report contents (in this case the tolerance data for the three holes), right-click the selection and click Print. The report will be printed to the system's active printer.

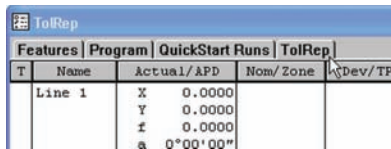

Select the active template...

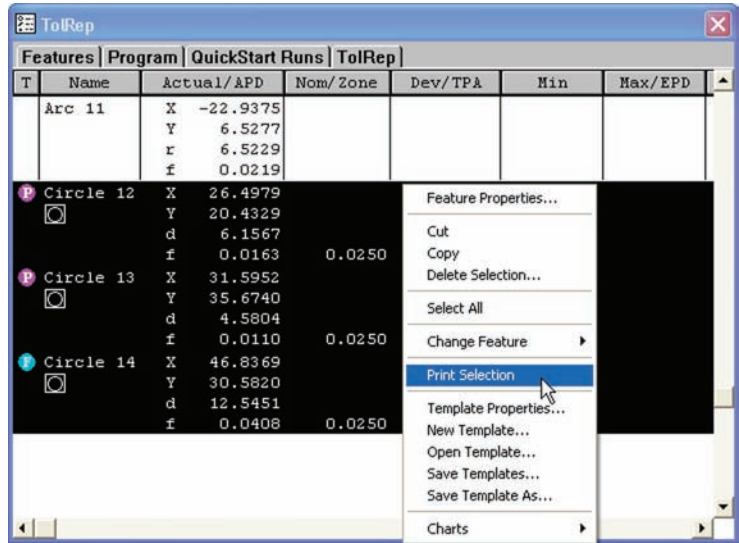

select the desired report contents, right-click the selection and click Print Selection

3 Quick Start Demonstration

## Turning program recording OFF

A detailed description of programming is provided by [Chapter 8: Programming](#). Click the Pause Program toolbar button to finish recording your measurement activities as a program.



All measurement, tolerancing, exporting and printing activities recorded in the program will be repeated each time the program is run.

## Saving the part

Click the File/Save menu item to save the part including all feature data and the program. The part data and program will be saved in a part (.5pa) file in the default file location C:\QC5000\parts. The data from program executions will be saved in a runs (.5ru) file at the same default location.

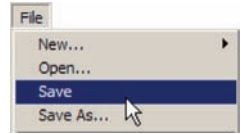

## Running the program

Click File and then click the part file name at the bottom of the File menu to load the part. Click the New Run toolbar button to run the program.

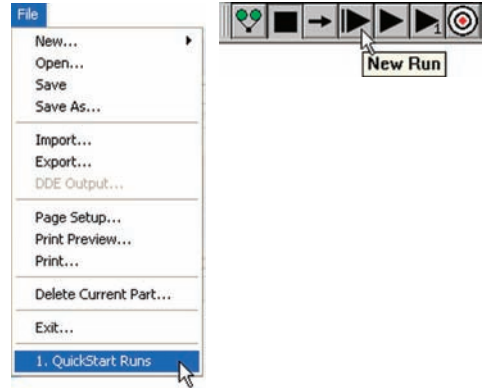

# Chapter 4:

# Probes

Measurements are conducted using video edge detection on manually controlled systems or on automated CNC systems. Part features can be probed manually by the user or automatically under program control. This chapter explains how to use and calibrate video probes.



## NOTE

The measurement, construction and creation of features using video probes is explained in **Chapter 5: Measuring**.

Here's what you'll find in this chapter:

Preparing to use video probes .....	77
System and part condition.....	77
Selecting video magnification.....	77
Adjusting light control .....	77
Associating lighting with magnifications .....	77
Enabling and disabling light associations .....	78
Using video probes.....	78
Selecting a probe type.....	79
Changing probe position.....	79
Changing probe orientation.....	79
Changing probe size.....	80
Changing scan direction.....	80
Changing edge detection order .....	81
Enabling and disabling high accuracy scanning .....	82
Firing video probes .....	83
Loading a video chart.....	84
Video probe descriptions .....	85
Crosshair probe .....	86
Simple probe .....	87
Buffer Probe.....	89
Average probe.....	91
Nearest probe .....	93
Farthest probe.....	94

Height probe.....	95
Width Probe .....	97
Circle Probe .....	98
Blob Probe .....	101
Worm probe .....	102
New probe.....	105
Pattern Finder probe.....	108
Initial setup of the video probe system .....	116
Adding magnifications to the Probe toolbar .....	117
Adding the highest magnification to the probe library .....	118
Adding other magnifications and associating Zoom positions .....	119
Deleting magnifications .....	120
Configuring the highest magnification .....	121
Configuring the lower magnifications .....	121
Calibrating auto focus.....	122
Calibrating video edge recognition (Teach) .....	124
Advanced Edge Teach .....	126
Calibrating pixel resolution.....	127
Calibrating offset .....	129
Compensating for camera skew.....	132
Configuring video probe data collection parameters .....	135

## Preparing to use video probes

The accuracy and repeatability of video probing depends on the general condition of the system and part, video magnification, part lighting and optical focus.

### System and part condition

The system is presumed to be well-maintained which implies a clean stage and optical system, free of scratches and other damage. The part to be measured is also presumed to be clean and undamaged.

### Selecting video magnification

Select the desired video magnification by clicking the corresponding probe toolbar button or Probes/Magnifications menu item. The magnifications that appear in the Probe menu and toolbar are setup in the Probe Library by supervisors, distributors and OEMs.

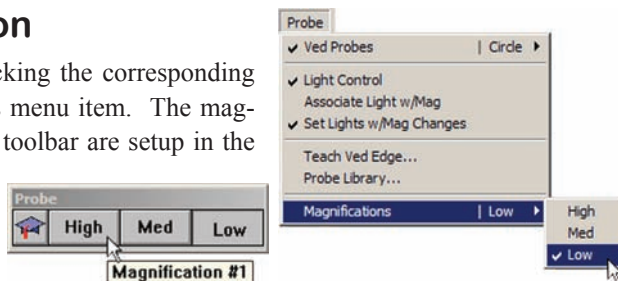

### Adjusting light control

Video backlighting and surface lighting are adjusted by operating the Lights slider controls. Click the Probe/Light Control menu item to display the Lights slider controls.

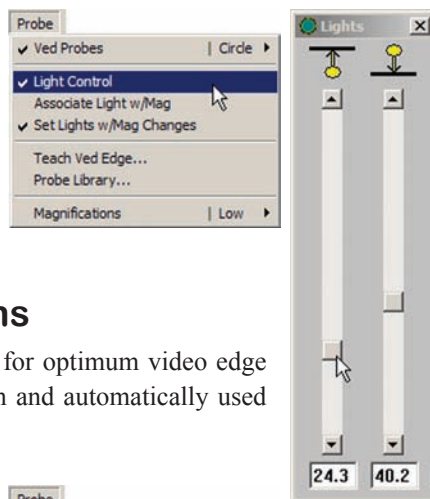

Lighting is described in detail in [Chapter 5: Measuring](#).

### Associating lighting with magnifications

Each video magnification can require unique light adjustments for optimum video edge recognition. The light adjustments can be stored by the system and automatically used each time the magnification is selected.

Click the Probe/Associate Light w/Mag menu item to store the current light levels for the current magnification.

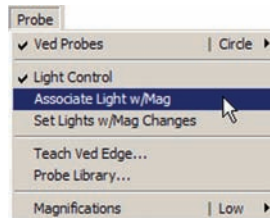

**NOTE**  
The Probe/Set Lights w/Mag Changes menu item must be checked for stored light adjustments to be applied to associated magnifications.

## Enabling and disabling light associations

Enable the light adjustments associated with magnifications by checking the Probe/Set Lights w/Mag Changes menu item.

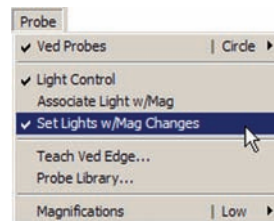

## Using video probes

A wide variety of video probes is available for measuring regular geometric features such as points, lines, arcs, circles and slots. Video probes are also available for measuring irregular features, features that extend beyond the field of view and entire part profiles. In addition, pass/fail charts can be imported and used to facilitate visual inspections.

Each video probe is comprised of one or more scan lines, each of which acquires a point as the scan crosses an edge bounded by light and dark areas of the screen image. For example, the Simple probe consists of a single scan line, while the default buffer probe contains 50 scan lines.

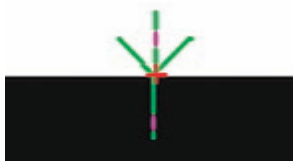

*The Simple probe acquires one point with a single scan*

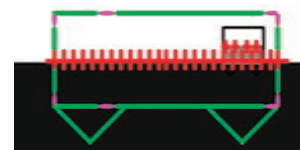

*The Buffer probe acquires many points with 50 scans*



### NOTE

The number of points acquired by multiscan video probes can be changed by supervisors, distributors and OEMs in the Probe Library.

Since many video probes simply consist of multiple scan lines, it is technically possible for these probes to measure several different feature types. However, each video probe is intended for specific measurements and measuring features for which the probe was not specifically designed is discouraged. For example, while a circle probe can perform a line measurement, higher accuracy and repeatability will be obtained by using the buffer probe to measure a line.

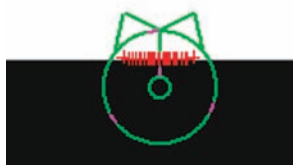

*While most probes can scan many feature types...*

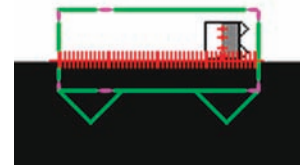

*always use a probe intended for the feature*

The video probe descriptions presented in this chapter include recommended feature measurements for each probe.



## Selecting a probe type

Select the desired probe type by clicking the corresponding the VED toolbar button or Probe/VED Probe menu item.

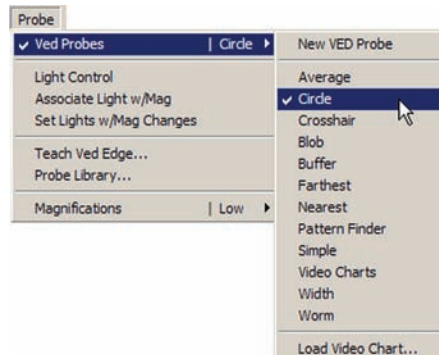

## Changing probe position

Click and drag a probe from one location to another using the open hand mouse cursor. The open hand mouse cursor is available inside a probe and anywhere on the screen outside the probe.

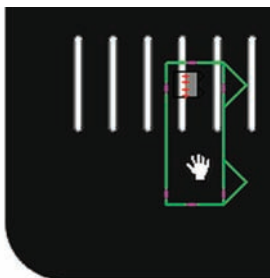

*Click and drag the probe using the open hand icon...*

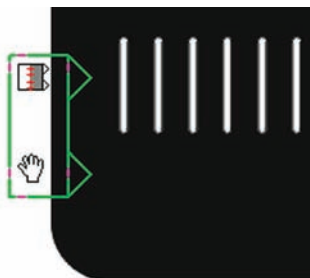

*to move the probe to a new location*

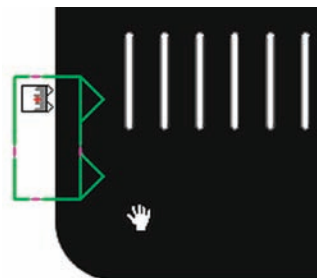

*The open hand icon is available inside or outside the probe*

## Changing probe orientation

Click and rotate a probe from one orientation to another using the pointer finger mouse cursor. The pointer finger icon becomes available when the mouse cursor is positioned over a corner or end of the video probe.

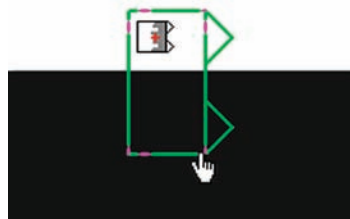

*Click a corner of the probe to with the pointer finger icon...*

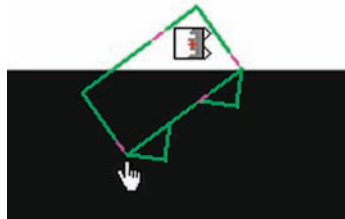

*and rotate (drag) the probe...*



*to a new orientation*

## Changing probe size

Click and drag an edge of any probe except the Simple and Worm probes to change the probe size using the closed fist mouse cursor. The closed fist icon becomes available when the mouse cursor is positioned over a probe edge.



*Click and drag a probe edge using the closed fist icon...*

*to change the probe size*

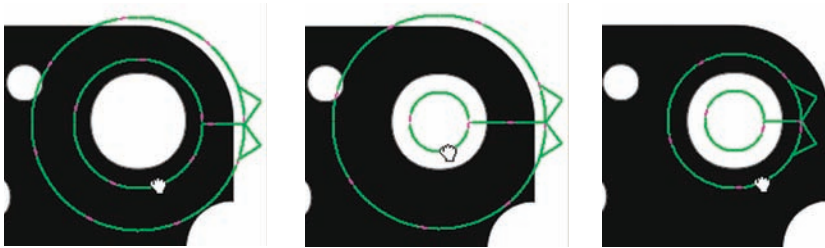

*Click and drag the inner and outer circle probe edges ... to change the probe size*

Click and drag an end of the Simple (or Worm) probe to change probe size using the pointer finger icon discussed earlier.

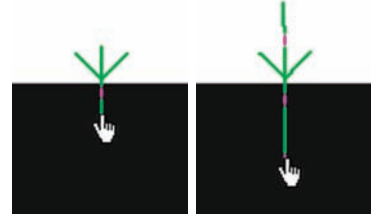

## Changing scan direction

Scan direction becomes important when the image contains more noise on one side of the edge being measured than on the other. The scan direction should always be from the cleanest side of the edge to the noisiest. Scan direction is indicated by the arrow(s) associated with each probe.

Click and drag an end or edge of a video probe using the pointer finger or closed fist icon to change the scan direction of the probe.

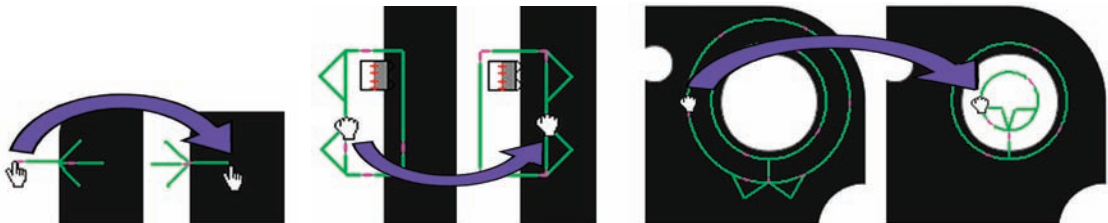

*Click and drag the probe ends or probe edges to change scan direction*

## Changing edge detection order

Edges are detected as the scan moves from light to dark, from dark to light or automatically when the first edge is encountered. Edge detection order is selected from the VED toolbar.



Double-clicking a probe cycles the edge detection order of the probe as shown here.

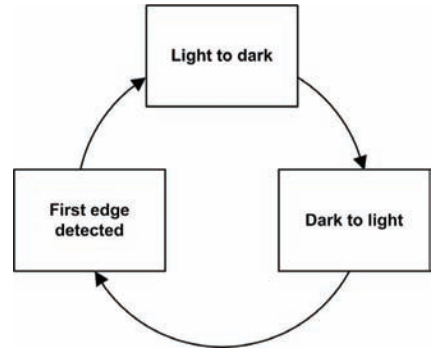

The edge detection order is indicated by the colors of the two halves of each video probe.



*Light to dark order is indicated by probe arrows in the dark*



*Dark to light order is indicated by probe arrows in the light*



*First edge is indicated by a single color probe*

The edge detection order must be consistent with the scan direction. For example, if the scan direction (from cleanest to noisiest) is from a dark area of the image to a light area, the edge detection order must be set to dark to light or first edge. When the edge detection order is inconsistent with the scan direction, no points will be acquired.

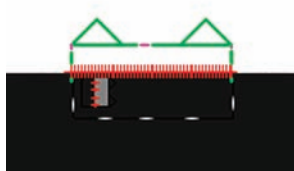

*Dark to light is consistent with the scan direction: probe fires*



*Automatic first edge: probe fires*

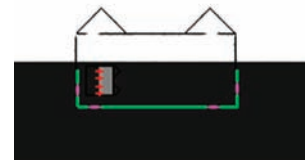

*Light to dark is not consistent with the scan direction: probe does not fire*

## Enabling and disabling high accuracy scanning

The accuracy of the QC5200 is extremely high even when the probing techniques of the operator are relaxed or hurried. However, small accuracy gains can be obtained by enabling the high accuracy mode. The high accuracy mode automatically optimizes probe positioning to orient scans orthogonal to the edge, and then returns points that are averaged from a series of three rapid probe firings. The extra processing required to reposition the video probe, fire the probe three times and return average point locations is minimal, and in most applications enabling the high accuracy mode is beneficial.

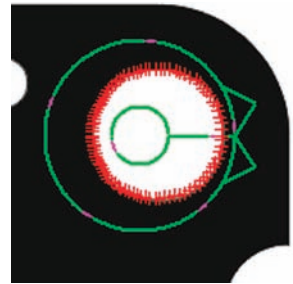

*A misaligned probe is fired*

Toggle the high accuracy mode on or off by right-clicking the live video window, and then clicking Other/High Accuracy, or by clicking the High Accuracy VED toolbar button.

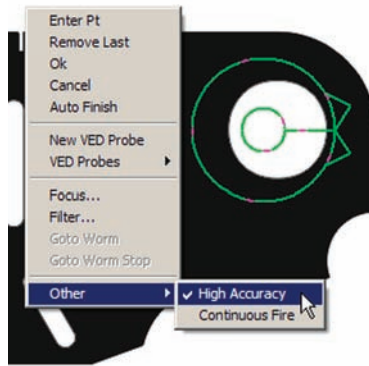
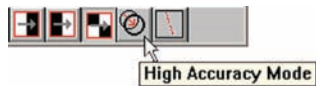

*The High Accuracy mode is enabled...*

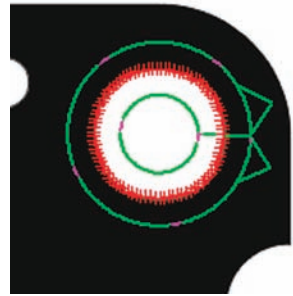

*then the probe is automatically aligned when the probe is fired*

## Firing video probes

Fire any video probe by clicking the center mouse button.

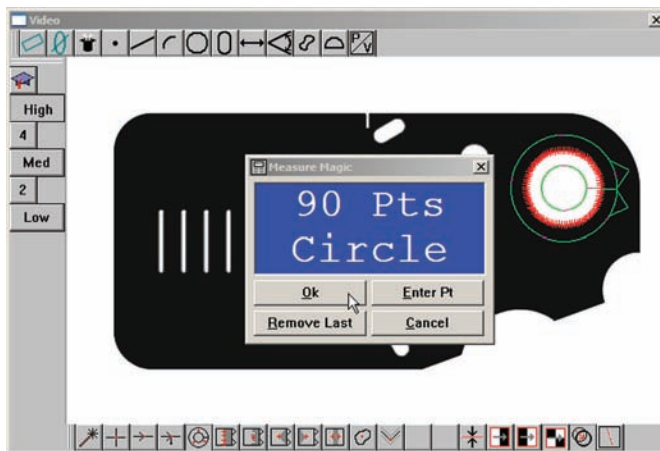

### Dry firing probes

Probes can also be fired by right-clicking the live video window and clicking Dry Fire Probe. When Measure Magic is enabled in the Tools/Options/Measure setup screen, the probe will acquire points, otherwise only an indication of scanned points will be displayed, and no points will be acquired.

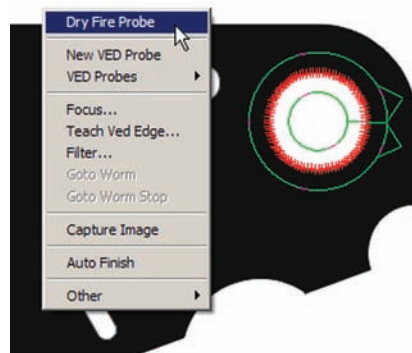

### Continuous probe firing

Probes can be dry-fired continuously to show data points that would be acquired under the current light, focus, part alignment and other current measurement conditions if the probe were actually fired. The data points are shown in blue until the probe is fired to acquire points, then the acquired points are shown momentarily in red.

Continuous probe firing is useful for setup and troubleshooting activities, but requires substantial system resources and should be avoided during routine use to maintain high throughput.

Click the Continuous Fire VED toolbar button to toggle continuous firing on or off.



## Loading a video chart

Video charts are Overlays that are superimposed over part images to facilitate visual inspections.



### NOTE

Video charts are created for specific parts and saved as .dxf files.



*Video chart for the visual inspection of a hole*

Click the Probe/VED Probes/Load Video Chart menu item to display the Video Chart file dialog box.

Select the desired chart file and click Open.

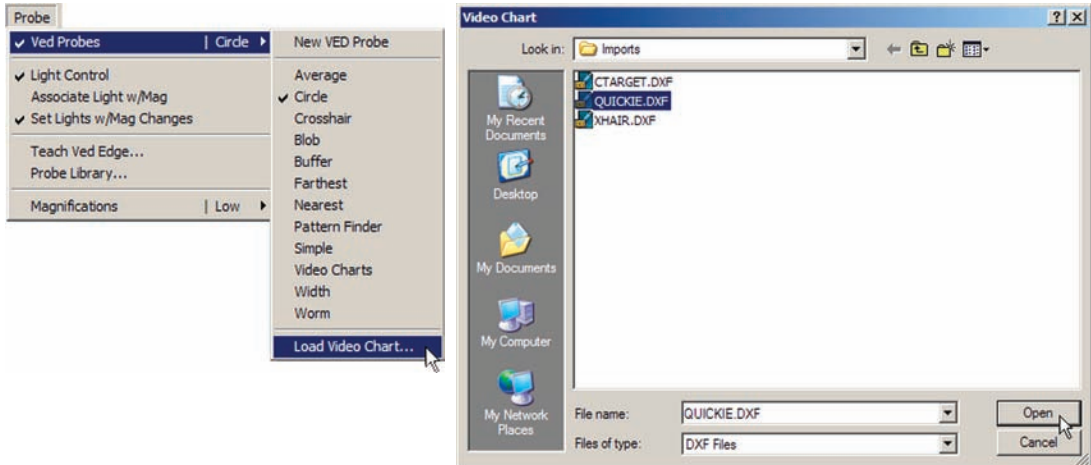

## Video probe descriptions

Video probes are available for measuring regular geometric features such as points, lines, arcs, circles and slots. Video probes are also available for measuring a regular features, features that extend beyond the field of view and entire part profiles. Pass/fail charts can also be imported and used to facilitate visual inspections. Video probes include:

- Crosshair Measures points in X-Y space without edge detection
- Simple Measures a single point at an edge crossing
- Buffer Measures a line at an edge crossing
- Average Returns the average point location of all points acquired along an edge transition by a buffer-like probe
- Farthest Returns the farthest point location of all points acquired along an edge transition by a buffer-like probe
- Nearest Returns the nearest point location of all points acquired along an edge transition by a buffer-like probe
- Height Returns the Z-axis location of the best focus within the area bounded by the probe
- Width Returns a distance comprised of 2 opposing points located at the average width of a line
- Circle Measures circles and arcs at edge crossings
- Blob Measures the center of mass and area of an irregular shape
- Worm Measures regular and irregular shapes, completely within or extending beyond the field of view.
- New Used to create a new Simple, Buffer, Circle or Worm probe quickly by clicking and dragging the mouse cursor within the live video window
- Pattern finder Used to learn and later to find a regular or irregular feature.
- Video charts Imports an overlay chart from a drawing file to be used in a visual pass/fail inspection

## Crosshair probe



The crosshair probe acquires a single point each time it is fired. The crosshair probe does not use video edge detection and is not used in conjunction with Measure Magic.

The crosshair probe can be used to acquire points for most feature measurements and is especially useful when measuring textured, transparent or other surface features that must be identified by careful visual inspection.

Select the probe from the Probe menu, the live video window on-screen menu or the VED toolbar. Move the probe or change its size as described earlier in this chapter.

To acquire a point, select a feature measurement, and click the center mouse button to fire the probe.

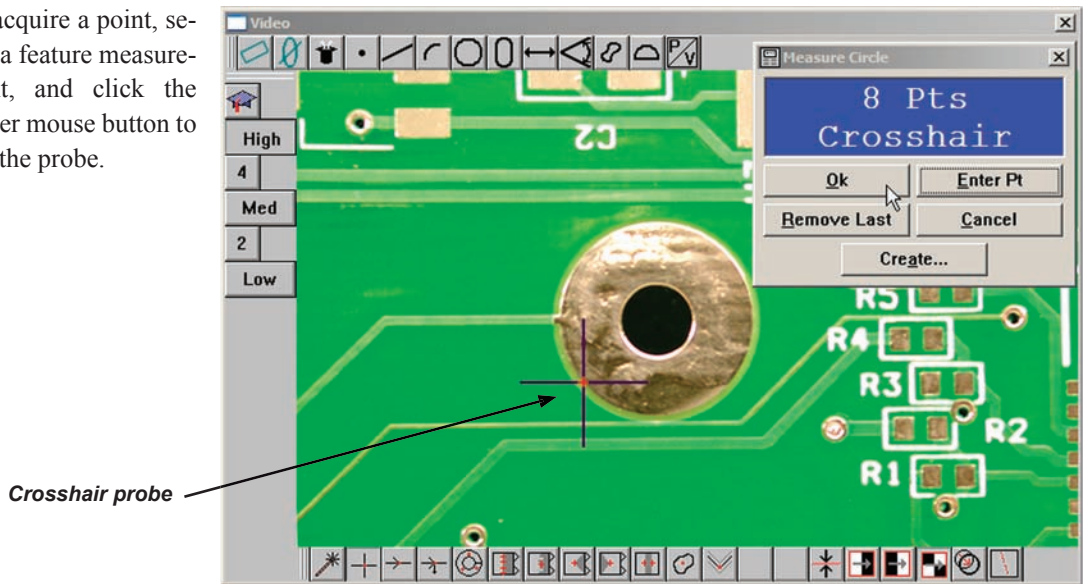

*The crosshair probe is used to measure a circular solder pad that might be more difficult to measure using edge detection*

Measurement results are sent to the Features template and the Results window. The results data depend on the type of feature measured. Point measurement results include:

- The feature type and feature number
- The number of points acquired and the number of points used to calculate feature data
- The geometric center location of the feature
- The form value

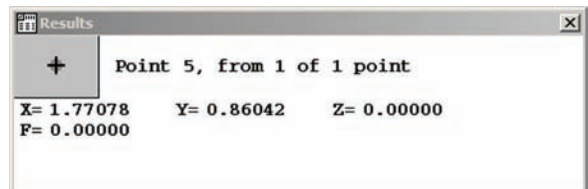



## Simple probe



The simple probe acquires a single point each time it is fired. The simple probe uses video edge detection and consists of a single scan line.

The simple probe can be used to acquire points for most feature measurements and is useful when there are space constraints or the part geometry makes it difficult to use a larger probe to acquire many points.

Select the probe from the Probe menu, the live video window on-screen menu or the VED toolbar. Move the probe, change its size or change its orientation as described earlier in this chapter.

To acquire a point, use Measure Magic or select a feature measurement, select and position the probe and then click the center mouse button to fire the Probe.

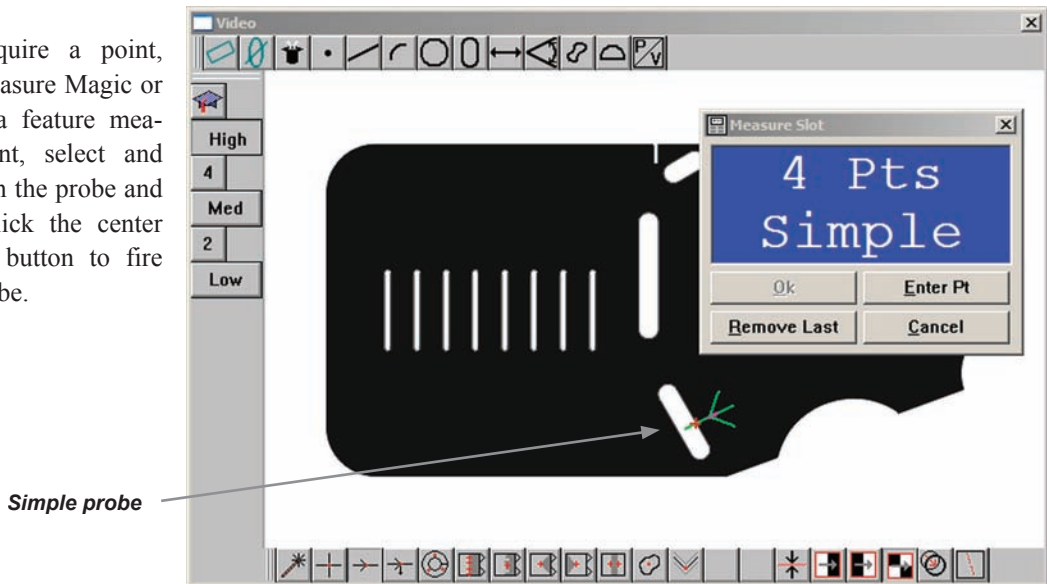

*The simple probe is used to measure a slot where 5 single points are required and edge detection is not possible*

The simple probe can be created quickly in the live video window by clicking and dragging the New probe across the edge to be scanned.

When the New probe creates a Simple probe, the edge order will automatically be made consistent with the scan direction. In this example, the edge order and scan direction are light to dark.

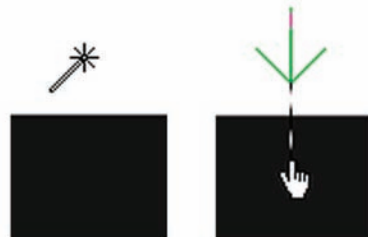

*The New probe is clicked and dragged across an edge to create a Simple probe*

Measurement results are sent to the Features template and the Results window. The results data depend on the type of feature measured. Point measurement results include:

- The feature type and feature number
- The number of points acquired and the number of points used to calculate feature data
- The geometric center location of the feature
- The form value

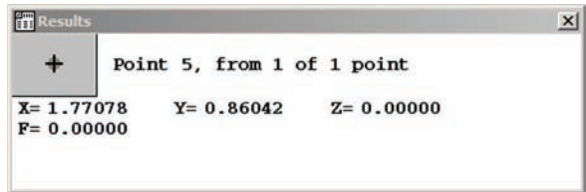

## Buffer Probe



The buffer probe uses edge detection to acquire many points along an edge each time it is fired. The default of 50 points can be changed by supervisors, distributors and OEMs in the Probe Library.

The buffer probe can be used to acquire points for line measurements, and can be fired once or multiple times on a single edge.

Select the probe from the Probe menu, the live video window on-screen menu or the VED toolbar. Move the probe, change its size or change its orientation as described earlier in this chapter.

To acquire points along an edge, use Measure Magic or select a feature measurement, select and position the probe over the edge and then click the center mouse button to fire the Probe.

*Buffer probe*

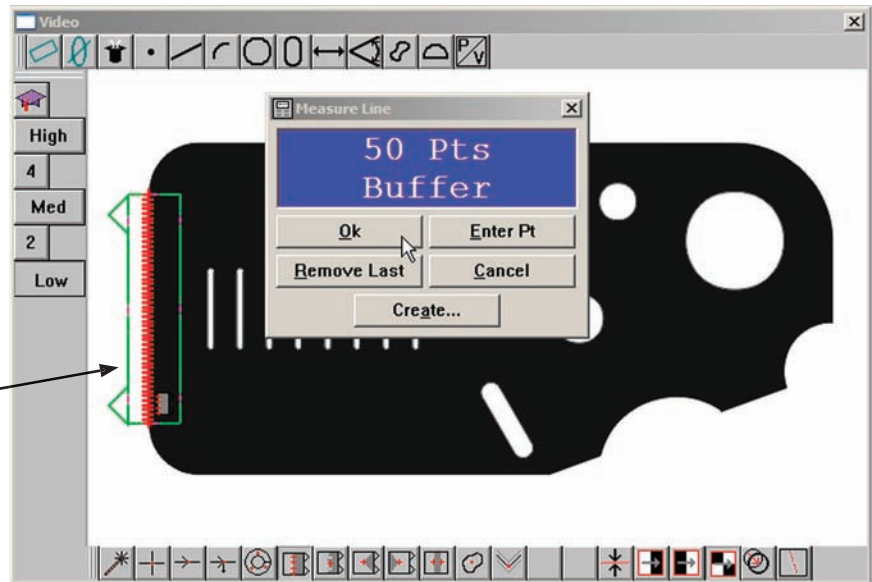

*The buffer probe is used to measure a line formed by the left edge of the part*

The buffer probe can be created quickly using the New probe in the live video window by clicking 2 points and dragging the second point across the edge to be scanned.

When the New probe creates a buffer probe, the edge order will automatically be made consistent with the scan direction. In this example, the edge order and scan direction are dark to light.

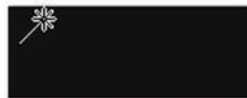

*The New probe is clicked twice and then...*



*the second point is dragged across the edge to create a Buffer probe*

The buffer probe can be obtained from a collection of six probes by clicking on the probe icon. Repeatedly clicking the probe icon cycles through the six probes shown here in this diagram.

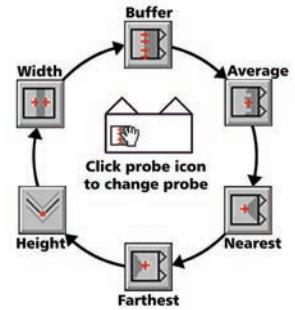

Measurement results are sent to the Features template and the Results window. The results data for line measurements include:

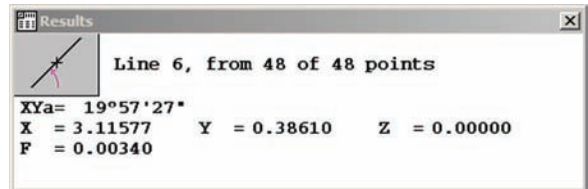

- The feature type and feature number
- The number of points acquired and the number of points used to calculate feature data
- The angle created between the line and the X-axis. Angles become more positive as they rotate counterclockwise.
- The geometric center location of the feature
- The form value

## Average probe



The Average probe uses edge detection to return a single point positioned at the geometric average location of many points acquired along an edge. The default of 50 points can be changed by supervisors, distributors and OEMs in the Probe Library.

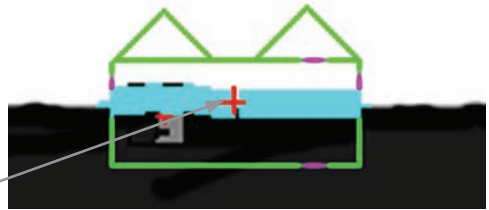

Average point

The average location of all points scanned along an irregular edge is returned as a single point

The average probe is typically used to determine the average location of a slightly irregular edge by acquiring multiple average points and then constructing a line.

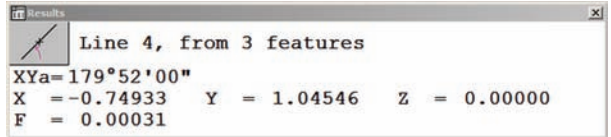
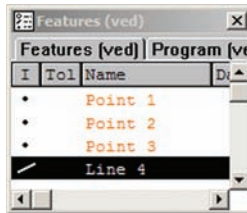
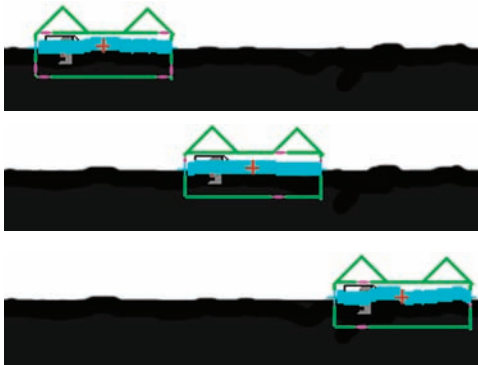

The top irregular edge of a molded part is measured by acquiring three average points that will be used to construct a line

Select the probe from the Probe menu, live video window on-screen menu or the VED toolbar. Move the probe, change its size or change its orientation as described earlier in this chapter.

To acquire an average point, select and position the probe over an edge then click the center mouse button to fire the probe.

The average probe can be obtained from a collection of six probes by clicking on the probe icon. Repeatedly clicking the probe icon cycles through the six probes shown in this diagram.

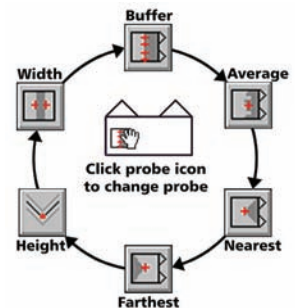

Measurement results are sent to the Features template and the Results window. The results data depend on the type of feature measured. Point measurement results include:

- The feature type and feature number
- The number of points acquired and the number of points used to calculate feature data
- The geometric center location of the feature
- The form value

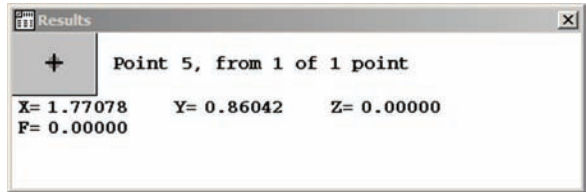

## Nearest probe



The Nearest probe uses edge detection to scan many points and return the single point positioned nearest to starting position of the probe scans when the scan direction is from light to dark. The probe scans every pixel line and the number of scans cannot be changed in the Probe Library.

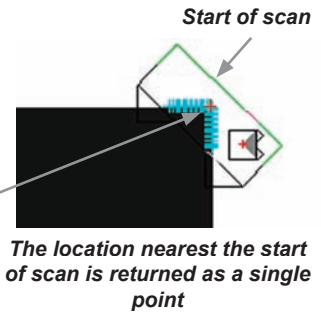

The nearest probe is typically used to determine the location of a corner or other prominence.



### NOTE

When the scan direction is from dark to light, the Farthest probe discussed on the next page can be used to determine the location of a prominence.



### CAUTION

The point identified as nearest to the start of scan side of the probe depends on the feature geometry and the probe orientation. Be careful to orient the probe so that the prominence being measured seems visually nearest to the start of scan side of the probe before firing the probe.

Select the probe from the Probe menu, live video window on-screen menu or the VED toolbar. Move the probe, change its size or change its orientation as described earlier in this chapter.

To acquire the nearest point, select and position the probe over a prominence then click the center mouse button to fire the probe.

The nearest probe can be obtained from a collection of six probes by clicking on the probe icon. Repeatedly clicking the probe icon cycles through the six probes shown in this diagram.

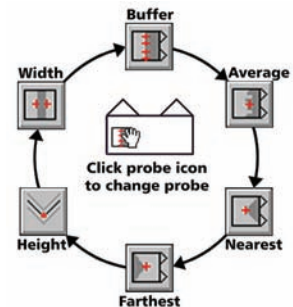

Measurement results are sent to the Features template and the Results window. Point measurement results include:

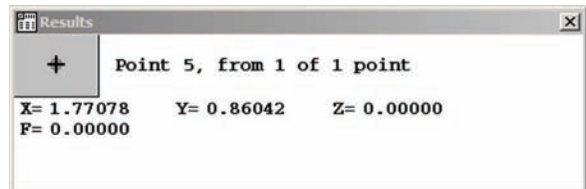

- The feature type and feature number
- The number of points acquired and the number of points used to calculate feature data
- The geometric center location of the feature
- The form value

## Farthest probe



The Farthest probe uses edge detection to scan many points and return the single point positioned farthest from the starting position of the probe scans when the scan direction is from dark to light. The probe scans every pixel line and the number of scans cannot be changed in the Probe Library.

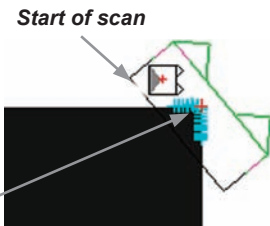

*The location farthest from the start of scan is returned as a single point*

The farthest probe is typically used to determine the location of a corner or other prominence.



### NOTE

When the scan direction is from light to dark, the Nearest probe discussed on the previous page can be used to determine the location of a prominence.



### CAUTION

The point identified as farthest from the start of scan side of the probe depends on the feature geometry and the probe orientation. Be careful to orient the probe so that the prominence being measured seems visually farthest from the start of scan side of the probe before firing the probe.

Select the probe from the Probe menu, live video window on-screen menu or the VED toolbar. Move the probe, change its size or change its orientation as described earlier in this chapter.

To acquire the farthest point, select and position the probe over a prominence then click the center mouse button to fire the probe.

The farthest probe can be obtained from a collection of six probes by clicking on the probe icon. Repeatedly clicking the probe icon cycles through the six probes shown in this diagram.

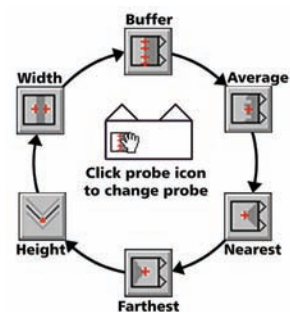

Measurement results are sent to the Features template and the Results window. Point measurement results include:

- The feature type and feature number
- The number of points acquired and the number of points used to calculate feature data
- The geometric center location of the feature
- The form value

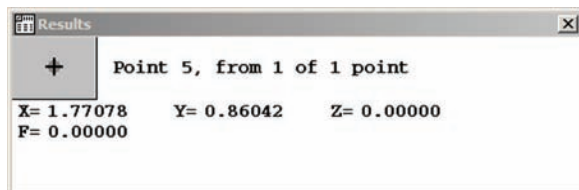



## Height probe



The Height probe uses edge detection and the auto focus algorithm to scan many points, focus on the highest Z-axis point and return this single point. The probe scans every pixel line bounded by the probe outline to maximize the data available to the auto focus algorithm. This number of scans cannot be changed in the Probe Library.



### CAUTION

The point identified as the highest Z-axis value depends on the feature geometry, number of scan lines and the probe orientation. Be careful use the largest probe box size possible at one elevation to maximize scan lines, and to orient the probe so that the scan lines are not parallel to the contrast features to insure good auto focus results.

Select the probe from the Probe menu, live video window on-screen menu or the VED toolbar. Move the probe, change its size or change its orientation as described earlier in this chapter.

To acquire the highest Z-axis point, select and position the probe over the largest area at the elevation of interest, then click the center mouse button to fire the probe.

*Highest point*

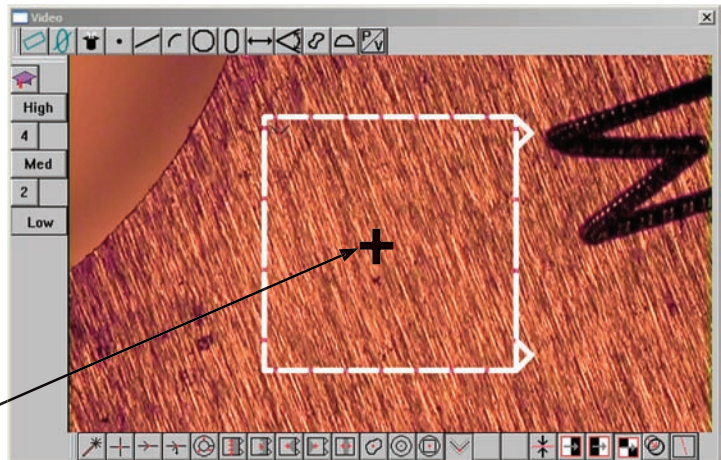

*The highest Z-axis location contained within the probe box is returned as a single point*

The Height probe is also used during datum creation to probe the 3 or more points needed to level the part.



### NOTE

Leveling is discussed in detail in [Chapter 5: Measuring](#). Leveling is optional.

The Height probe can be obtained from a collection of six probes by clicking on the probe icon. Repeatedly clicking the probe icon cycles through the six probes shown in this diagram.

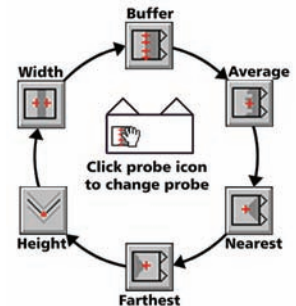

Measurement results are sent to the Features template and the Results window. Point measurement results include:

- The feature type and feature number
- The number of points acquired and the number of points used to calculate feature data
- The geometric center location of the feature
- The form value

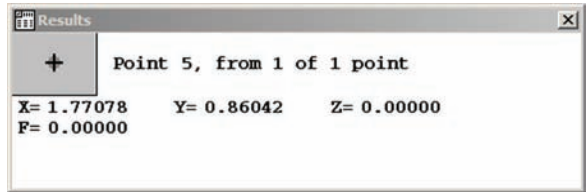

## Width Probe



The Width probe uses edge detection scanned in opposing directions to return two points on opposite sides of a line each time it is fired. Many points on both sides of the line are acquired and processed by the width algorithm to find the average line width. The default of 50 points can be changed by supervisors, distributors and OEMs in the Probe Library.

The Width probe is used to measure line widths that are returned as distances in the Features template.

Select the probe from the Probe menu, the live video window on-screen menu or the VED toolbar. Move the probe, change its size or change its orientation as described earlier in this chapter.

To measure line width, select and position the Width probe over the line and then click the center mouse button to fire the Probe.

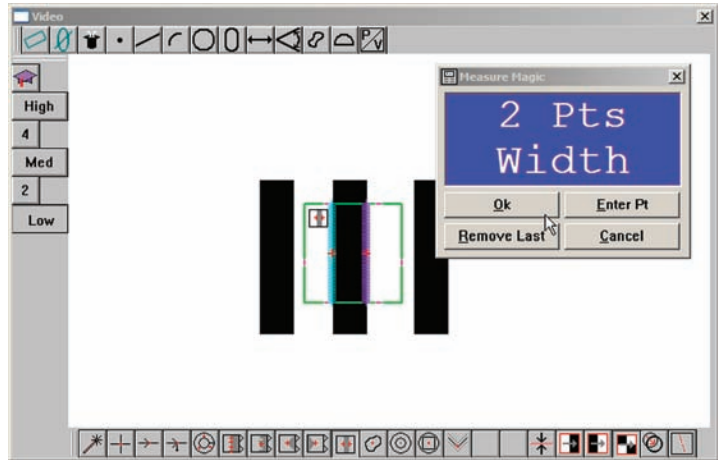

*The width of a line is returned as two opposing points*

The Width probe can be obtained from a collection of six probes by clicking on the probe icon. Repeatedly clicking the probe icon cycles through the six probes shown in this diagram.

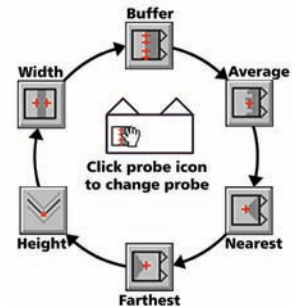

Measurement results are sent to the Features template and the Results window. Width measurement results include:

- The feature type and feature number
- The number of points acquired and the number of points used to calculate feature data
- The length (width) across the line
- The geometric center location of the feature

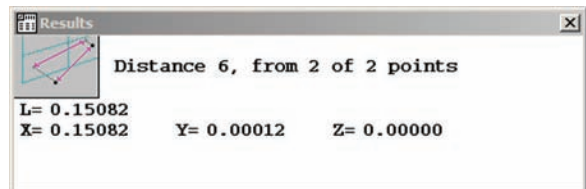

## Circle Probe



The Circle probe uses edge detection to acquire many points along an edge each time it is fired. The default of 90 points can be changed by supervisors, distributors and OEMs in the Probe Library.

The Circle probe can be used to acquire points for circle and arc measurements.

Select the probe from the Probe menu, the live video window on-screen menu or the VED toolbar. Move the probe, change its size or change its orientation as described earlier in this chapter.

### Circles

To acquire points along a circle edge, use Measure Magic or select a circle feature measurement, select the probe and position it over the circle and then click the center mouse button to fire the Probe.

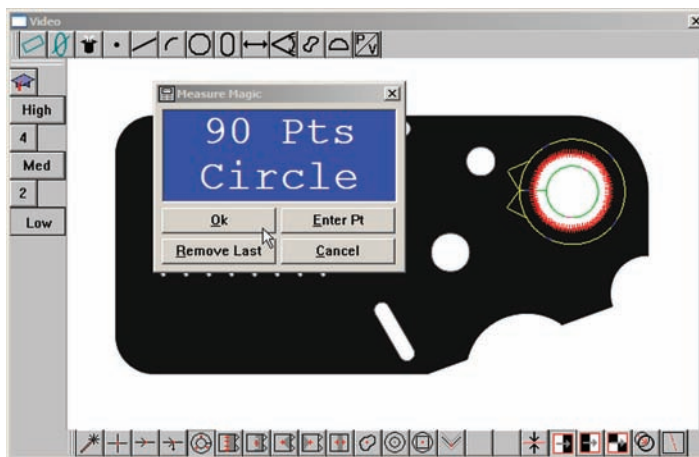

*A circle measurement is performed using the circle probe*

The Circle probe can be created quickly using the New probe in the live video window by clicking 3 points and dragging the third point across the edge to be scanned.

When the New probe creates a Circle probe, the edge order will automatically be made consistent with the scan direction.



#### NOTE

Clicking the New probe in an arc greater than 180 degrees creates a full Circle probe. Clicking an arc less than 180 degrees creates an arc segment of the Circle probe.



*The New probe is clicked three times and then...*

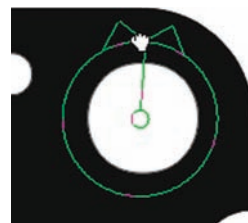

*the third point is dragged across the edge to create a Circle probe*

Measurement results are sent to the Features template and the Results window. Circle measurement results include:

Results		
Circle 1, from 83 of 90 points		
r= 0.25081	d= 0.50162	
X= 1.24053	Y= 0.34796	Z= 0.00000
F= 0.00623		

- The feature type and feature number
- The number of points acquired and the number of points used to calculate feature data
- The circle radius and diameter of the circle
- The geometric center location of the feature
- The form value

## Arcs

To acquire points along an arc edge, use Measure Magic or select a arc feature measurement, select the Circle probe and position it near the arc. The circle probe must now be configured to measure the arc. To acquire points along the edge of an arc:

- 1 Click the circle dividing line and drag the circle open to the approximate arc length.

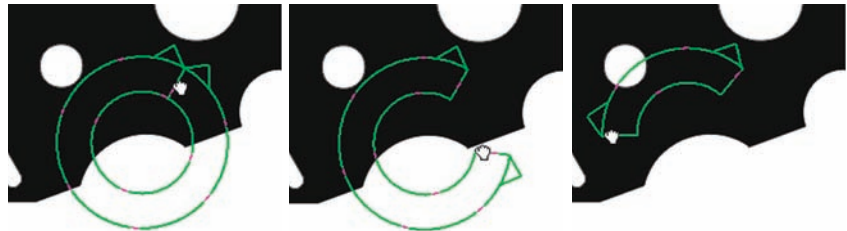

*The Circle probe is clicked and dragged open to the approximate arc length*

- 2 Position the circle probe segment over the arc, then fit the segment to the arc using techniques discussed earlier in this chapter.

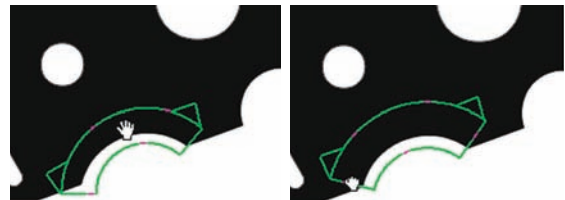

*The probe is positioned and fit precisely over the arc*

- 3 Enable the High Accuracy mode to optimize probe positioning when the probe is fired and click the center mouse button to fire the probe.

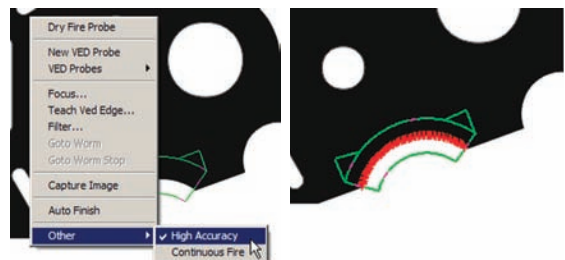

An arc segment of the Circle probe can be created quickly to measure an arc using the New probe in the live video window by clicking 3 points and dragging the third point across the arc edge to be scanned.

When the New probe creates a the probe, the edge order will automatically be made consistent with the scan direction.



*The New probe is clicked three times and then...*

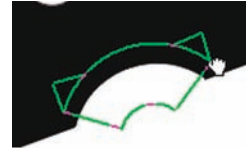

*the third point is dragged across the edge to create a Circle probe*

Measurement results are sent to the Features template and the Results window. Arc measurement results include:

- The feature type and feature number
- The number of points acquired and the number of points used to calculate feature data
- The circle radius and diameter or the arc
- The length of the arc in degrees
- The geometric center location of the feature
- The form value

Results		
Arc 2, from 87 of 90 points		
I= 0.25456	d= 0.50913	L= 118°50'21"
X= 1.24194	Y= 0.35189	Z= 0.00000
F= 0.00747		

## Blob Probe



The Blob probe partitions the distribution of grayscale levels contained within the boundary of the Blob probe box to acquire and display the many points that characterize the shape of an object. The number of points acquired cannot be changed in the Probe Library.

The Blob probe can be used to acquire points for the measurement of regular and irregular shapes.

Select the Blob probe from the Probe menu, the live video window on-screen menu or the VED toolbar. Move the probe, change its size or change its orientation as described earlier in this chapter.

To acquire points along the edge of a feature, select a Blob feature measurement, select the Blob probe, position it around the feature and then click the center mouse button to fire the Probe.



*The Blob probe is used to measure a solder pad*

Measurement results are sent to the Features template and the Results window. Blob measurement results include:

- The feature type and feature number
- The number of points acquired and the number of points used to calculate feature data
- The geometric center location of the feature
- The area of the feature
- The maximum and minimum distances across the area
- The circumference (or perimeter) of the feature

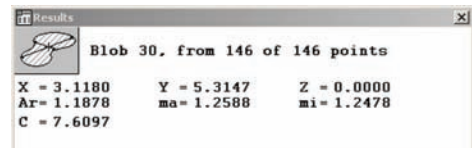

## Worm probe



The worm probe generates a series of scans perpendicular to and across the perimeter of a feature edge in the direction indicated by the probe. Each scan acquires a data point at the edge of the image. The maximum number of scans and the distance between scans can be changed in the Probe Library by supervisors, distributors and OEMs.

The worm probe is used to measure regular and irregular features, totally included within the field of view or extending beyond the field of view. The worm tool can be used to measure lines, arcs, circles and profiles.

Select the Worm probe from the Probe menu, the live video window on-screen menu or the VED toolbar. Move the probe, change its size or change its orientation as described earlier in this chapter.

To acquire points along the edge of a feature, select a feature measurement or Measure Magic, select the Worm probe, position it at the edge of the feature, select a scan direction and then click the center mouse button to fire the Probe.

Measurement results are sent to the Features template and Results window and depend on the feature type measured.

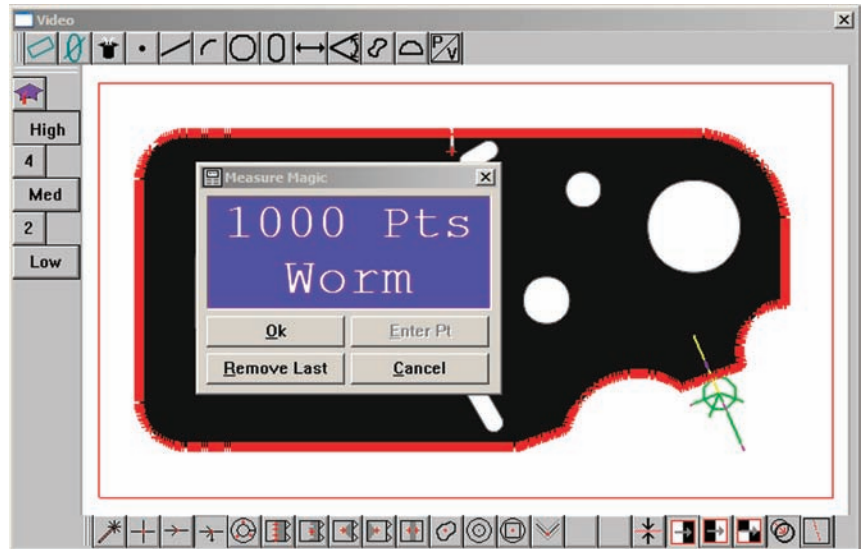

*The Worm probe is used to acquire points for a profile measurement*

### Changing the scan direction

Features are scanned around their perimeters in the direction indicated by the Worm tool's scan line. The scan direction can be toggled between counter-clockwise and clockwise by clicking the hand cursor on the scan line.

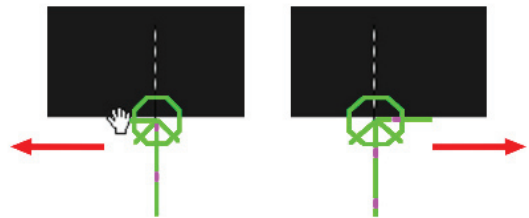

*Click the scan line to change the scan direction*



## Terminating perimeter scans

The scanning process stops when:

- The scans are interrupted by the field of view rectangle
- The scans are terminated by the stop sign
- Scans are completed around an entire perimeter

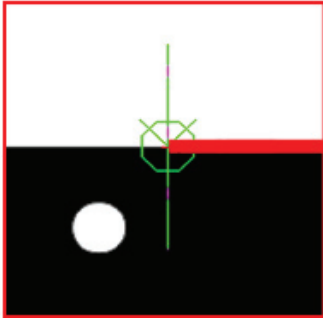

*Scans are terminated by the field of view rectangle*

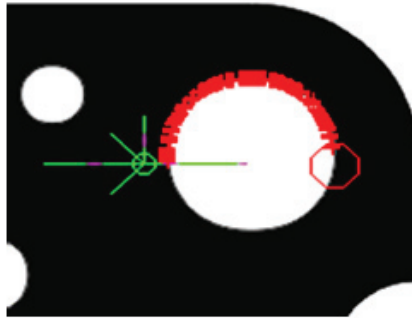

*Scans are terminated by the stop sign*



*Scans are completed around the perimeter of the feature*

## Terminating scans with the stop sign

When separated from the worm probe, the stop sign can be placed at any point on the image edge to terminate the scanning process.

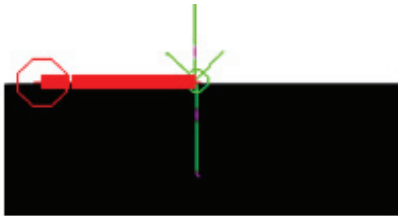

*Stop sign placed for scanning left*

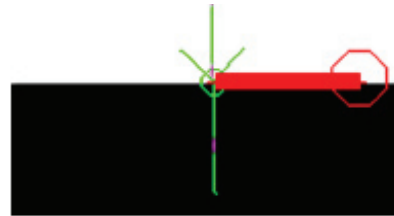

*Stop sign placed for scanning right*

Separate the stop sign from the worm probe by double-clicking the hand icon over the center of the probe. The stop sign can then be positioned at any point by clicking and dragging it.

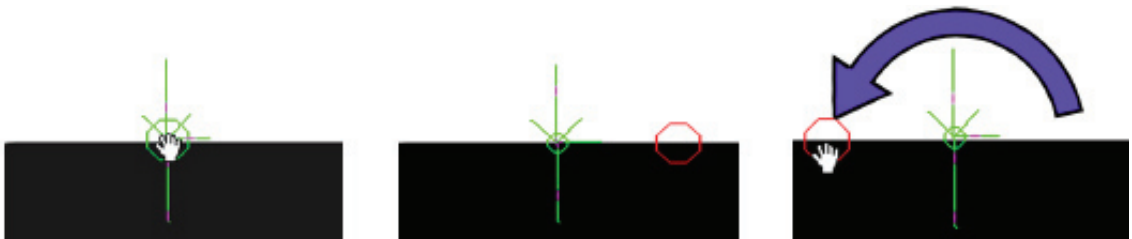

The stop sign is green when it is connected to the Worm probe, and red when separated. The stop sign is reunited with the probe by clicking and dragging it back over the center of the probe and releasing the mouse button, or by double-clicking the stop sign.

### Extending scans beyond the field of view

The field of view is indicated by a rectangle that encloses the contents of the video window. Red rectangles stop scans at the edge of the field of view, green rectangles permit the scanning to extend beyond the field of view in systems equipped with CNC capabilities.

The field of view rectangle can be toggled from red to green to extend scanning beyond the field of view rectangle. Click on the field of view rectangle to toggle it between red and green. When scans are extended beyond the field of view, the CNC stage will repeatedly reposition the camera over the part so that all required perimeter edges are scanned.

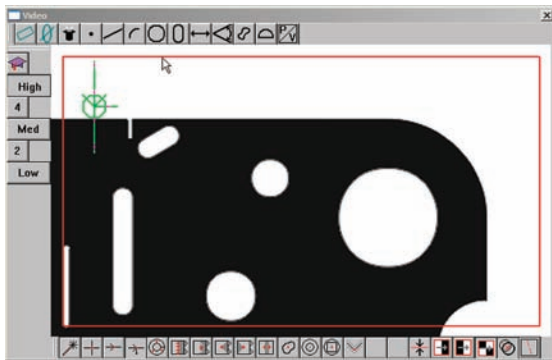

*Click the red field of view rectangle...*

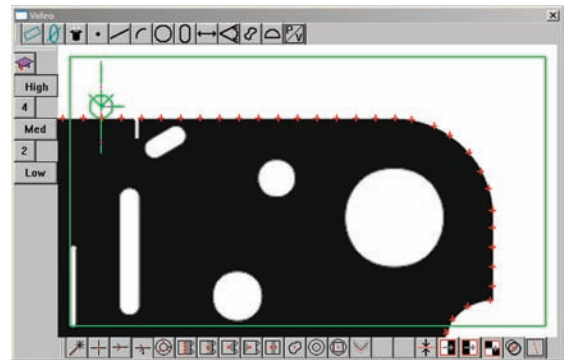

*to permit scans beyond the field of view*

The Worm probe can be created quickly using the New probe in the live video window by double-clicking and dragging the New Probe in the desired scan direction.



*Double-click and drag the New probe...*

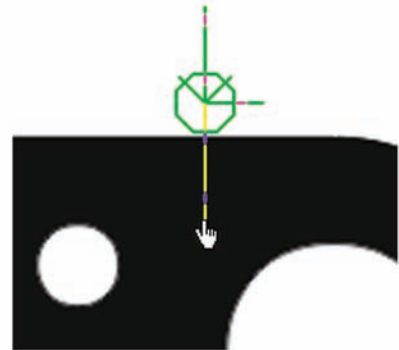

*to create a Worm probe*

When the New probe creates a Worm probe, the edge order will automatically be made consistent with the scan direction.

## New probe



The New probe is used to create video probes quickly in the live video window by clicking and dragging the probe across an edge or by pressing the center mouse button. Often measurements are performed more efficiently by creating the desired video probe using the new probe than by selecting, moving, re sizing and reorienting a video probe selected from the toolbar or a menu. When probes are created with the New probe they:

- Are created over the desired feature
- Are the appropriate size for the measurement
- Are automatically placed in the correct edge detection light orientation

The following video probes can be created using the New probe:

- Simple probe Measures points
- Worm probe Measures irregular and regular shapes
- Buffer probe Measures lines and can be changed to other probes by clicking the probe icon
  - Average probe Returns an average point
  - Nearest probe Returns the nearest point
  - Farthest probe Returns the farthest point
  - Height probe Returns the highest point
  - Width probe Returns 2 points that define the width of a line
- Circle probe Measures circles and arcs

Measurement results are sent to the Features template and Results window and depend on the feature type measured.

### ***Creating the Simple probe***

Click and drag the New probe across an edge.

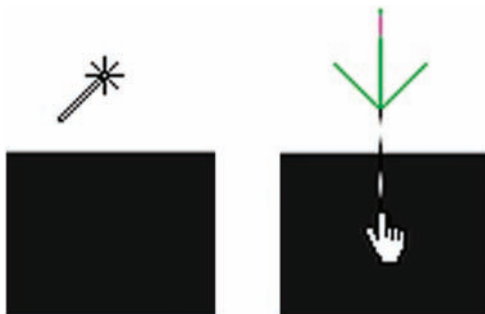

*The New probe is clicked and dragged across an edge to create a Simple probe*

### Creating the Buffer probe

Click one point and then click and drag a second point across an edge.

When the buffer probe has been created, click the probe icon repeatedly to cycle through the Average, Nearest, Farthest, Height, and Width probes.



*The New probe is clicked twice and then...*



*the second point is dragged across the edge to create a Buffer probe*

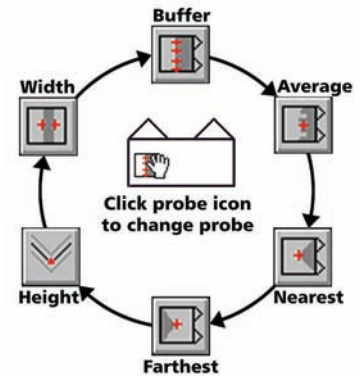

### Creating the Circle probe

Click two points then click and drag the third point across an edge. The three points must describe an arc of greater than  $180^\circ$  to measure a circle, and must be less than  $180^\circ$  to measure an arc.



*The New probe is clicked in an arc  $>180^\circ$  and then...*

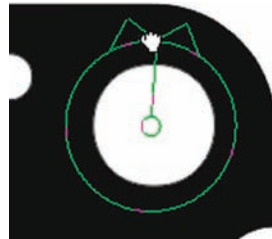

*the third point is dragged across the edge to measure a circle*



*The New probe is clicked in an arc  $<180^\circ$  and then...*

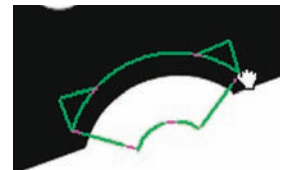

*the third point is dragged across the edge to measure an arc*

Circles can also be measured by positioning the New probe inside a circle and then clicking the center mouse button.

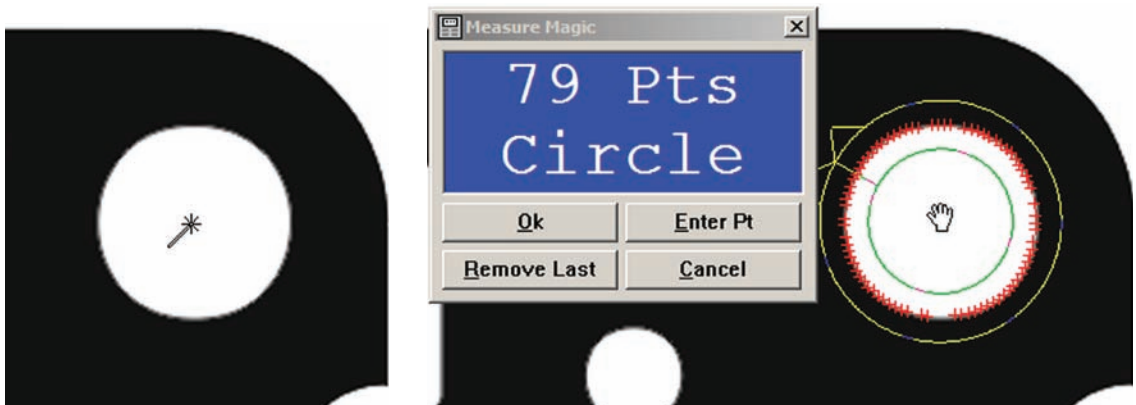

*Position the New probe inside a circle...*

*and click the middle mouse button to measure the circle*

### ***Creating the Worm probe***

Double-click and drag the New probe across an edge.



*Double-click and drag the New probe...*

*to create a Worm probe*

## Pattern Finder probe



The Pattern Finder probe is used to teach and later to find features having regular or irregular patterns. Pattern finding is usually included in programs to minimize operator interaction when a datum is created automatically for each of a series of parts or when some feature locations are not repeatable due to part variations. Use the Pattern Finder probe to:

- Teach the pattern bounded by the Pattern Finder probe rectangular box
- Find the pattern taught earlier and return a single point at the center of the pattern

### Teaching the pattern

To teach the Pattern Finder probe a pattern, select the Pattern Finder probe, position and size the probe over the target pattern and click the Probe/Teach Pattern Model menu item. The system will attempt to teach the entire contents of the Pattern Finder probe box and you will be informed of the failure or success by a brief message on the screen and by the color of the pattern finder Circle.

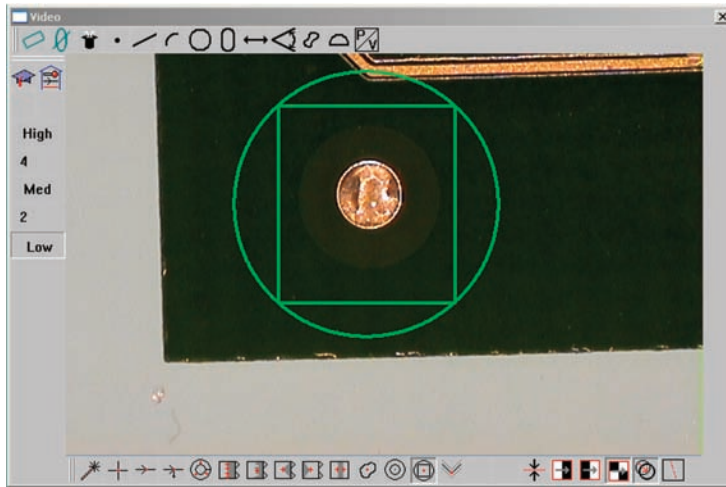

*The Pattern Finder probe is positioned over a printed circuit fiducial...*

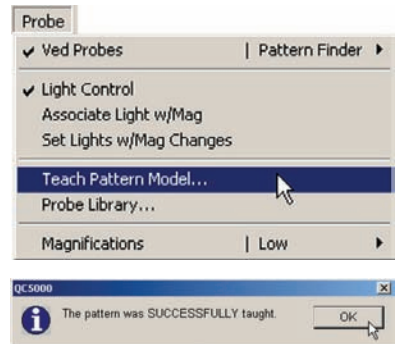

*then taught the fiducial pattern*

The default colors of the circle after a pattern teach are:

- Successful teach: Green circle
- Unsuccessful teach: Red circle



#### NOTE

The pattern finder can be taught any pattern, including total white or total black. Pattern teach failures are extremely rare and indicate issues involving memory or other system resources that should be referred to IT or other PC support professionals.

## Finding the pattern

Patterns can be found inside or outside the field of view. In either case, to begin a search for a pattern, select the Pattern Finder probe and fire it by clicking the center mouse button. When the pattern is contained within the field of view, the Pattern Finder probe will be automatically positioned over the pattern and will return a point located at the center of the probe box. Then the probe will be returned to its original location.

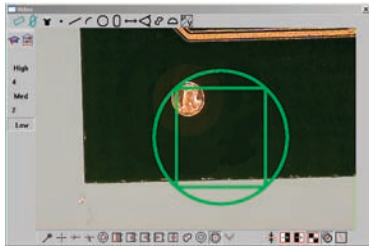

*When the Pattern Finder probe is fired...*

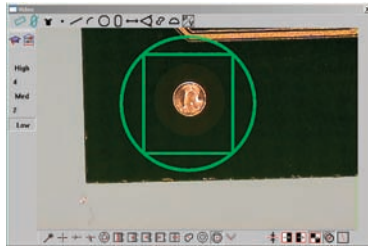

*the probe is moved over the pattern to acquire the point...*

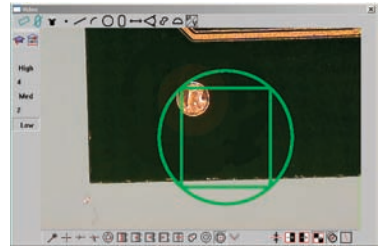

*and then the returned to its original position*

The measurement result is a point and is sent to the Features template and the Results window. Point measurement results include:

- The feature type and feature number
- The number of points acquired and the number of points used to calculate feature data
- The geometric center location of the pattern
- The form value

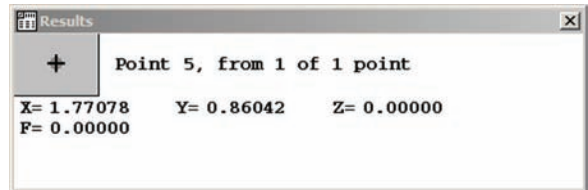

If the pattern is located outside the field of view, and if search rings were specified in the Tools/Options/VED setup screen, the system will begin a systematic clockwise search of rings of areas outside the current field of view to find the pattern.



### NOTE

Details regarding the setup of Pattern Finder search rings are contained in the VED screen portion of [Chapter 10: Supervisor Setup](#).

### Creating a datum automatically

The Pattern Finder probe is often included in programs to create part datums automatically when measuring a series of unlike parts or when measuring parts without fixturing. In these cases, the Pattern Finder probe is used to find the landmark features necessary to construct a preliminary datum, and then used again to find the precisely located datum features for the measurement datum.

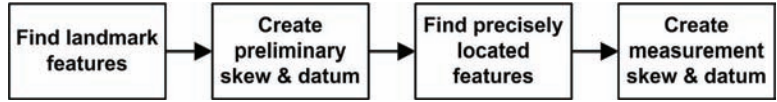

The steps described above will be shown in the following example of creating a datum for a printed circuit board without fixturing. First, the two bottom corners of the board will be found and used to create a preliminary datum, then two fiducials will be used to create a precise measurement skew and datum.

#### Find and teach landmark features

The programmer moves the stage to position the bottom-right corner of the printed circuit board under the video camera. The pattern probe is then positioned over the corner, re sized and taught the corner pattern. The probe is fired to return a point at the center of the pattern.

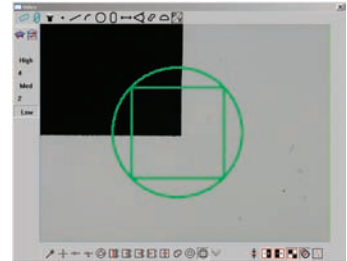

The programmer then moves the stage to position the bottom-left corner of the printed circuit board under the video camera, then teaches and fires a probe to return a second point.

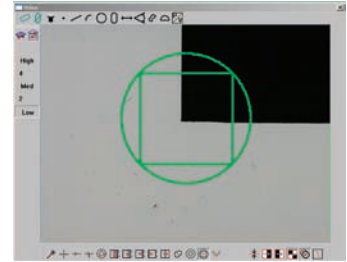

#### Create preliminary skew and datum

The two corner points are selected and used to construct a preliminary skew.

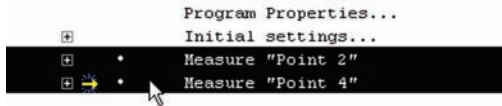

The two corner points are selected...

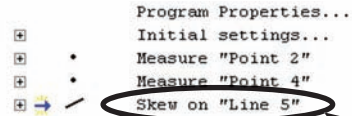

and used to construct a preliminary skew

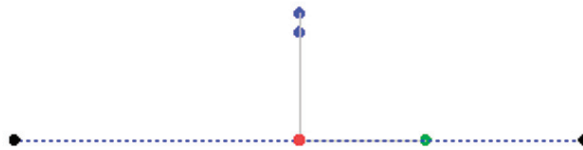

The preliminary skew extends from corner to corner



The bottom-left corner is then selected and used to create a preliminary datum zero.

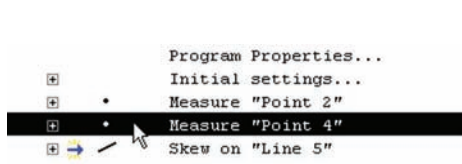

The bottom-left corner point selected...

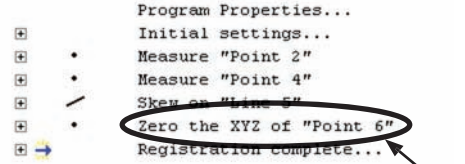

and used to construct a preliminary datum zero



The preliminary datum is created at the bottom-left corner

### Find and teach precisely located features

Now that the preliminary skew and datum are established, each of the two fiducials required for a precise skew and datum can easily be found within a field of view area at the system's lowest magnification.

The programmer moves the stage to position the first fiducial at the left side of the printed circuit board under the video camera. The pattern probe is then positioned over the fiducial, re sized and taught the fiducial pattern.

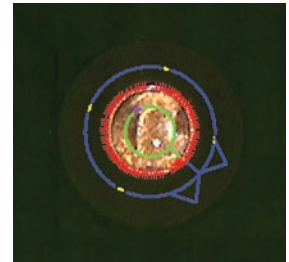
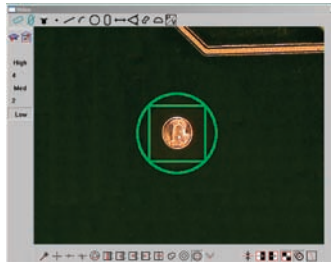

The Circle probe is then positioned over the fiducial and fired to return a point at the center of the fiducial at the left side of the board.

The programmer moves the stage to position the second fiducial at the right side of the printed circuit board under the video camera. The pattern probe is then positioned over the fiducial, re sized and taught the fiducial pattern.

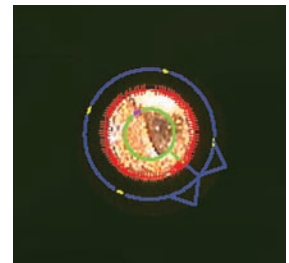

The Circle probe is then positioned over the fiducial and fired to return a point from the center of the fiducial at the right side of the printed circuit board.

**Create measurement skew and datum**

The two fiducial center-points are selected and used to create the precise skew for measurements.

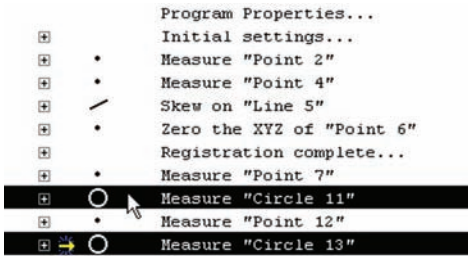

*The two fiducial centers are selected...*

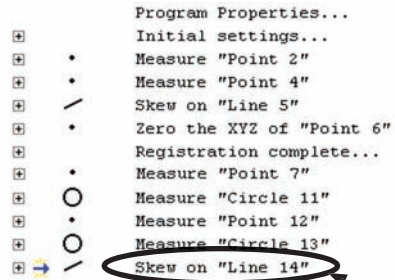

*and used to construct a measurement skew*

The bottom-left fiducial center point is selected and used to create a datum zero for measurements.

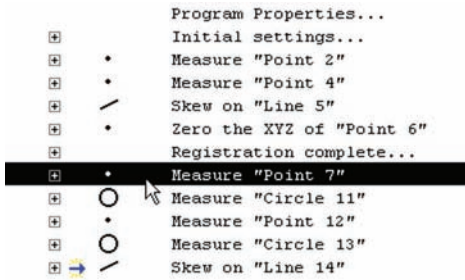

*The bottom-left fiducial center is selected...*

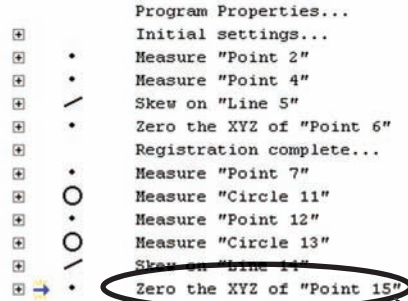

*and used to create a measurement datum zero*

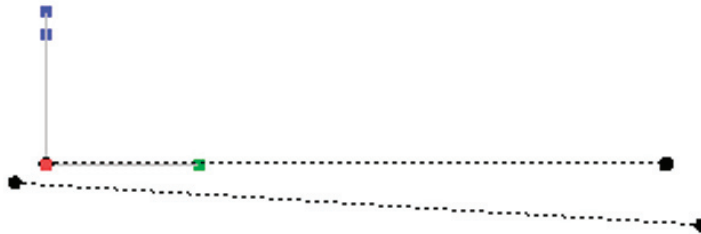

*The measurement skew and datum zero are shown above the original preliminary skew and datum*

**Finding features when part variations exist**

The Pattern Finder probe is often included in programs to locate features when part variability would make it difficult or impossible without operator intervention. In these cases, the part is fixtured and a reliable datum is established, but part variability causes the repeatability of certain feature locations to be low. The program steps for finding and measuring a feature when a part datum exists but part variability is an issue are diagrammed here.



When these program steps run, the feature will be located by the Pattern Finder probe and moved to the center of the field of view so that a video probe can be reliably positioned for measurement. Without these steps, part variability would make video probe positioning unreliable without operator intervention.

The steps described above are shown in the following example of measuring the top-left hole of a pattern of six holes in a printed circuit board.

**Move to the feature**

The programmer moves the stage to place the pattern of six holes under the video camera.

**Teach and fire the Pattern Finder**

The Pattern Finder probe is positioned over the top-left hole, re sized and taught the hole pattern. Then the probe is fired to return a point at the center of the hole pattern. The programmer clicks OK to complete the measurement.

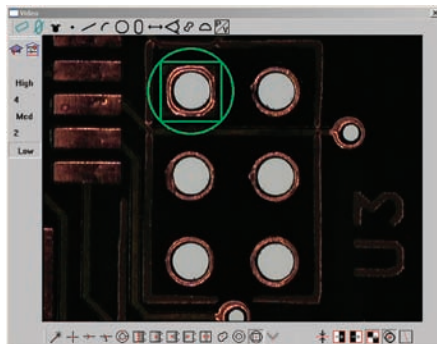
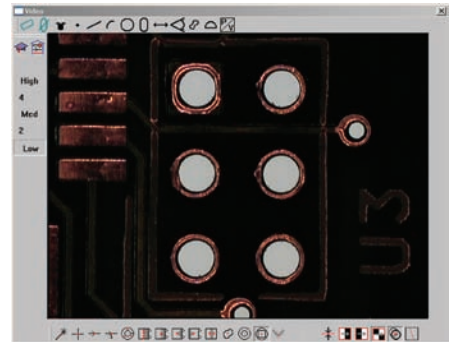

*The Pattern Finder probe is positioned...*

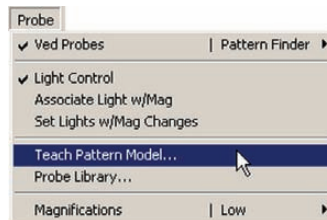

*taught the hole pattern...*



*and fired to return a point at the center of the hole*

### Add step: Goto selected feature

At this step in the programming process, the point returned from the center of the hole pattern is the currently selected feature. Adding a Goto Selected Feature step at this time will cause the system to position the stage with the hole feature at the center of the field of view. This key step guarantees that the hole will be located in a known position prior to its measurement, independent of part variability.

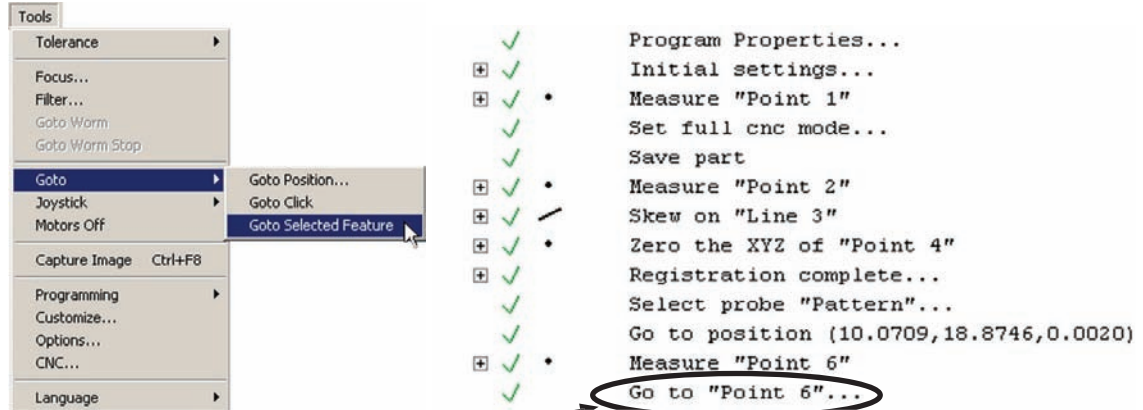

*Adding a Goto Selected Feature step...*

*positions the target hole feature in the center of the field of view*

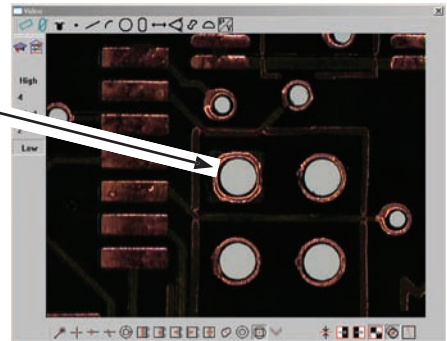

### Measure feature

Now that the hole feature is located at the center of the field of view, the Circle probe is used to measure it.

Default probe positioning is based on the assumption that part variability is very low, so absolute probe coordinates are recorded as the program is created, and then used again to position the probe each time the program is executed. When part variability is an issue, the recorded probe position is no longer a reliable indicator of the required probe position for new parts.

Since the last CNC move positioned the hole feature at the center of the field of view, the required probe position is also at the center of the field of view. Therefore, preventing any

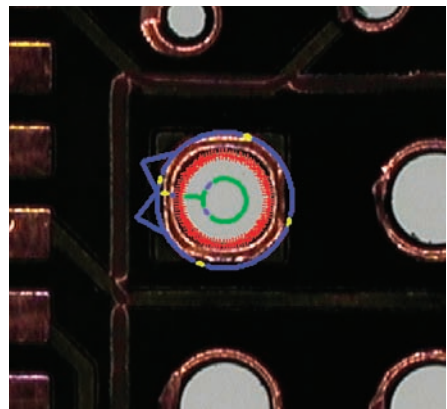

*The hole is measured at the center of the field of view*

probe movement away from the current position will guarantee an ideal probe position for measurement. Probe movement prior to measurement is prevented by expanding the measure circle superstep, changing the move type from absolute to relative and entering zeros for relative move coordinates.

```

Measure "Circle 8"
  Select probe "Circle"...
  Wait for point(s) at (0.7450,1.5480,0.0000)...
  Light control (1000.0,0.0,328.0,328.0,328.0,328.0)
  Finish measurement
  
```

*Expand the measure circle superstep...*

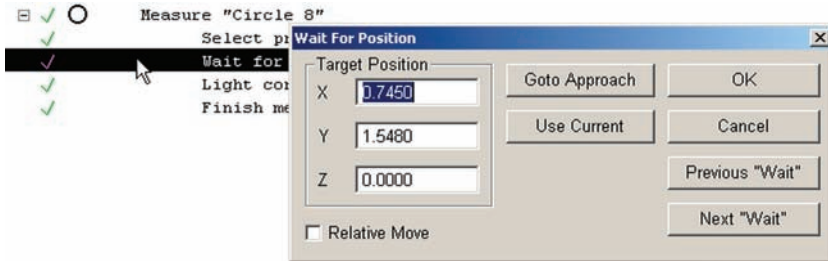

*double-click the Wait for point step to display the dialog box...*

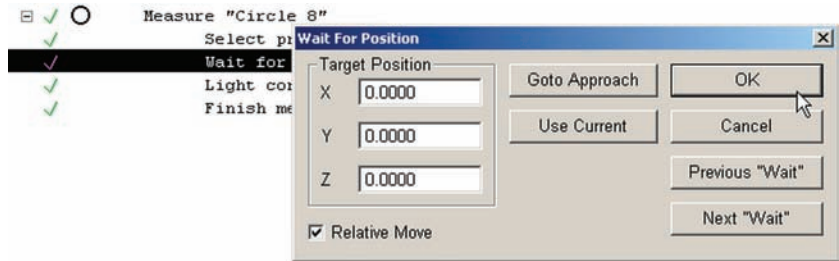

*enter zero target position coordinates and set the Relative mode*

When the program is executed, the hole will be found by the Pattern probe, centered in the field of view and measured. The influence of part variations will have been eliminated by finding and centering the part and by forcing a measurement over the selected feature location.

## Initial setup of the video probe system

The initial setup of the video probe system includes the addition of video magnifications with associated zooms followed by the configuration of the highest magnification, configuration of the lower magnifications, calibration of camera skew and configuration of data collection parameters for each probe type. The setup steps are diagrammed below and are explained in detail in the remainder of this chapter.

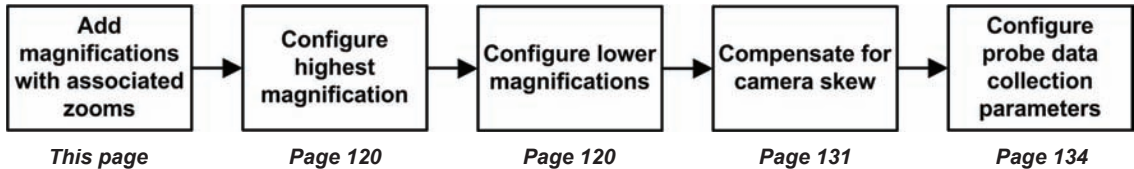

### CAUTION

Probe setup functions are restricted to individuals who can provide the supervisor password in one of the setup screens found under the Tools menu. Operators should not attempt to perform any of the calibration or other procedures included in the remainder of this chapter.

## Adding magnifications with associated zooms

The process of adding magnifications with associated zoom positions is diagrammed here and explained in subsequent paragraphs.

As the system is used, video magnifications are selected from the Probe menu, and more often in typical use from the Probe toolbar.

As new magnifications are added, they automatically become available for selection from the Probe menu. However, magnifications must be added to the Probe toolbar using the Tools/Customize/Toolbars screen to become available from the Probe toolbar.

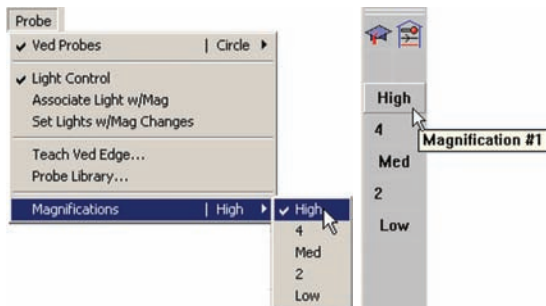

*Magnifications are selected from the Probe menu or from the Probe toolbar*

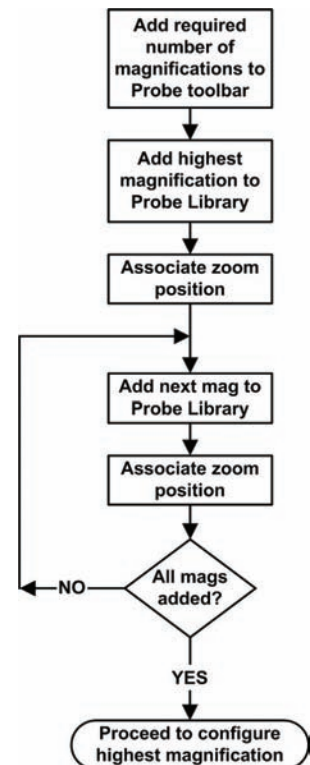

## Adding magnifications to the Probe toolbar

To add magnifications to the Probe toolbar:

- 1 Click the Tools/Customize/Toolbars tab to display the Toolbars setup screen.
- 2 Click Probe in the Toolbars list to display the buttons contained in the toolbar.
- 3 Select the required number of new *mag\_?* placeholder magnifications from the Possible Buttons list, and then click Copy to add the buttons to the Toolbar list.

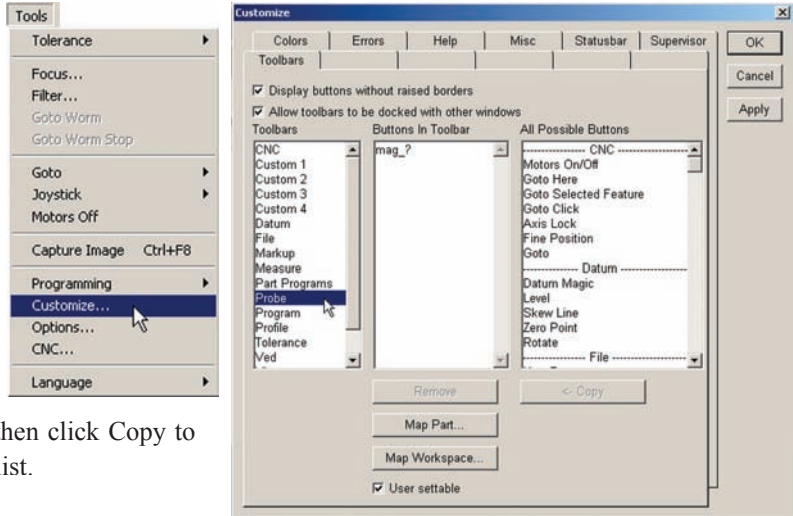

In this example, 4 magnification buttons were added to the first placeholder magnification to create a Probe toolbar with 5 magnification buttons.

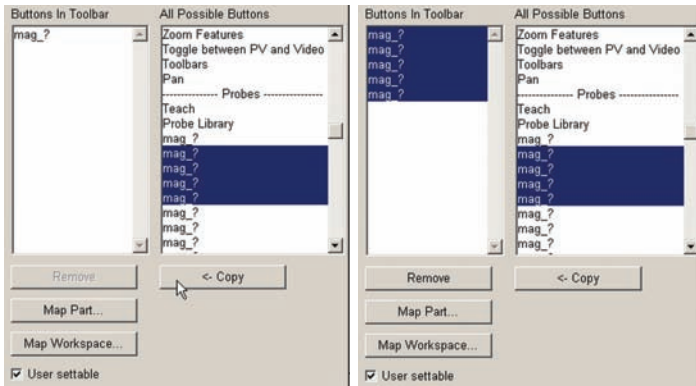

**Copying 4 more placeholder magnifications into the Buttons in toolbar list of the Probe toolbar...**

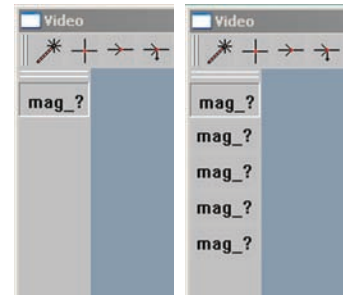

**adds 4 magnification buttons to the Probe toolbar**

## Adding the highest magnification to the probe library

Initially, the probe library contains one placeholder magnification with a generic name (mag or mag\_?). New magnifications are added with user-defined names, however the initial placeholder magnification cannot be renamed and so must be replaced. In this example, it will be replaced with a new magnification named “High”, which will become the highest of 5 magnifications. To replace the initial placeholder magnification:

- 1 Click the Probe/Probe Library menu item to display the Probe Library screen, then expand VED and click Camera 1 to display the camera's video magnifications.

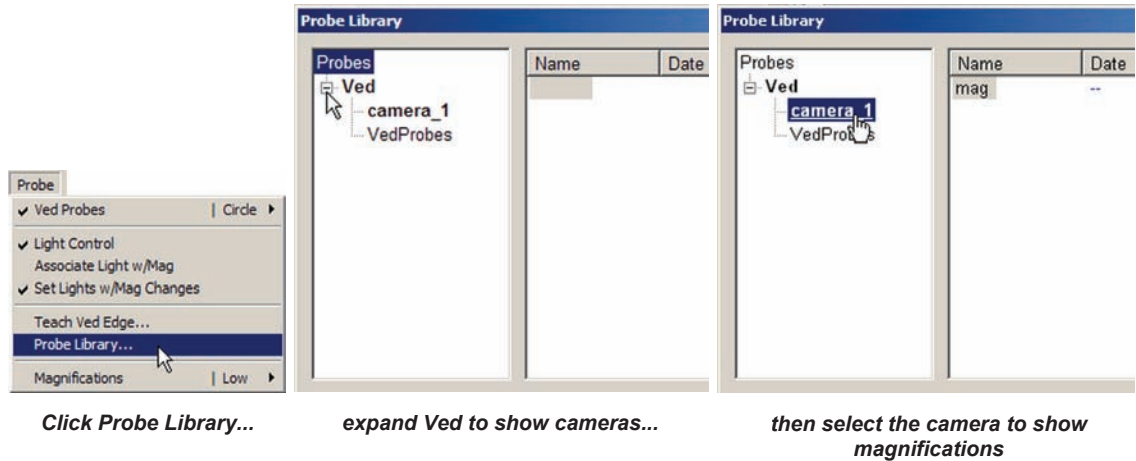

- 2 Click New to add a new magnification. The Create a New Probe Library Item dialog box will be displayed.

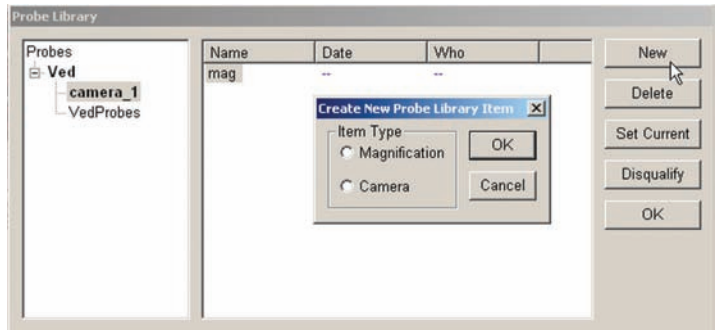

- 3 Click the Magnification Item Type and then click OK. The New Mag dialog box will be displayed.

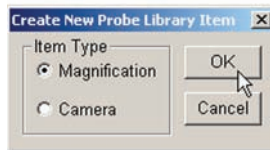



4 Enter the desired name (High in this example) then click OK. The new magnification will be displayed in the list.

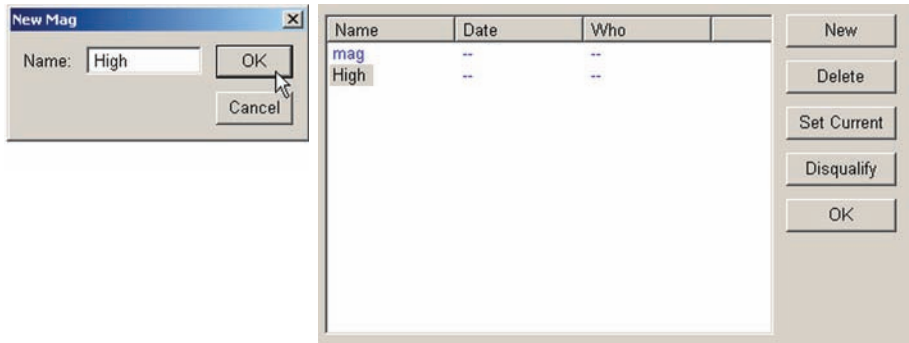

## Adding other magnifications and associating Zoom positions

It is assumed here that optical Zoom positions have already been assigned by the OEM or distributor, and that information regarding Zoom positions and the associated magnifications is available to you. To associate a Zoom position with a magnification:

5 Select the magnification and enter the desired Zoom position into the Mag tab at the lower portion of the screen.

Finish adding magnifications and associating Zoom positions for all the magnifications by repeating steps 2 through 5 until all the required magnifications have been added and a Zoom position is associated with each one.

In this example, 5 magnifications were added as shown below.

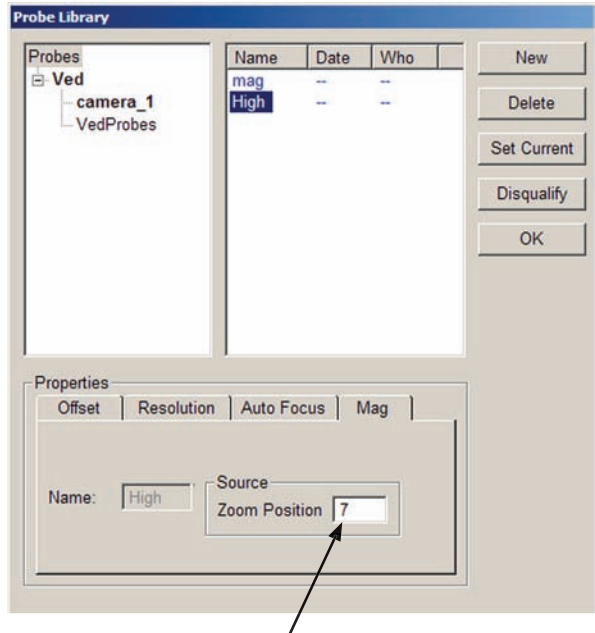

*Enter the zoom position for the selected magnification*

Magnification	Zoom position
High	7
4	5
Med	4
2	3
Low	1

## Deleting magnifications

Occasionally it might become necessary to delete a magnification. In our example, the initial placeholder magnification should be deleted but is still the current magnification, and as such cannot be deleted. In general, to delete a magnification:

1 Select a different magnification (the High mag in this example) and click Set Current to set it as the current magnification. Now the desired magnification can be deleted.

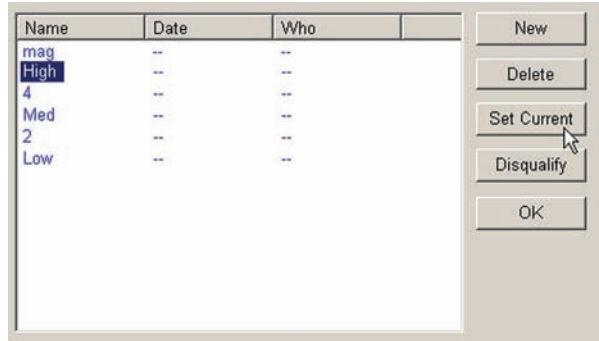

2 Select the magnification you wish to delete and click Delete.

You will be asked to confirm your intention. Click Yes to finish deleting the magnification.

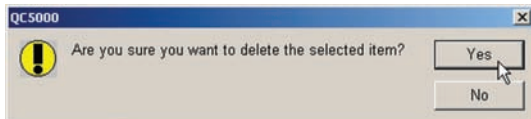
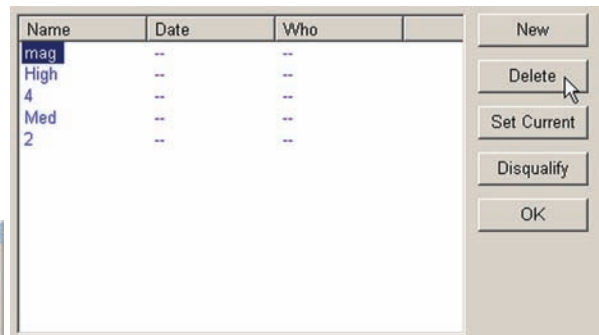

### Configuring the highest magnification

The auto focus, edge recognition, pixel resolution and offset should be configured for the highest magnification before configuring the parameters for lower magnifications.

Please refer to the page numbers shown near the diagram for instructions regarding configuration steps.

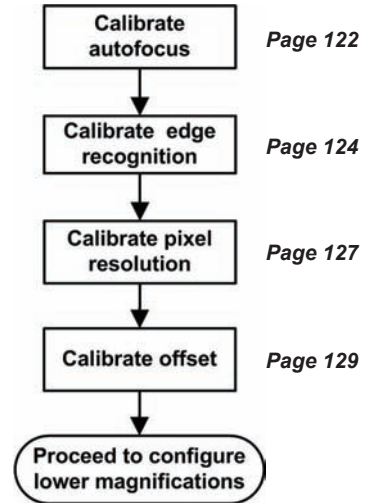

### Configuring the lower magnifications

The auto focus, edge recognition, pixel resolution and offset should be configured for the highest magnification before configuring the parameters for lower magnifications.

Please refer to the page numbers shown near the diagram for instructions regarding configuration steps.

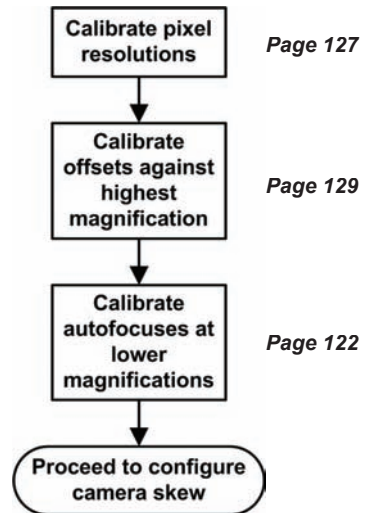

## Calibrating auto focus

Auto focus is calibrated for the highest magnification as the first step of the entire video probe system setup process.



### NOTE

Auto focus should not be calibrated for lower magnifications until all configuration steps are performed for the highest magnification, and pixel resolutions and offsets are calibrated for the lower magnifications. Refer to the diagrams on the previous page for the correct sequence of steps.

To calibrate auto focus:

- 1 Click Probe Library to display the Probe Library screen, then click the Auto Focus tab in the lower portion of the screen.

The screenshot shows the software interface for calibrating auto focus. On the left, a 'Probe' menu is open, with 'Probe Library...' selected. The main window is titled 'Probe Library' and contains a tree view on the left with 'Ved' expanded to show 'camera\_1' and 'VedProbes'. A table on the right lists probe configurations:

Name	Date	Who
High	--	--
4	--	--
Med	--	--
2	--	--
Low	--	--

On the right side of the 'Probe Library' window, there are buttons for 'New', 'Delete', 'Set Current', 'Disqualify', and 'OK'. Below the table is a 'Properties' section with tabs for 'Offset', 'Resolution', 'Auto Focus', and 'Mag'. The 'Auto Focus' tab is selected. In this tab, there are input fields for 'Search Dist:' (0.00000) and 'Focus offset:' (0.00000), along with a 'Teach...' button.

2 Click the Teach button to begin the auto focus calibration process and display the Focus Teach dialog box.

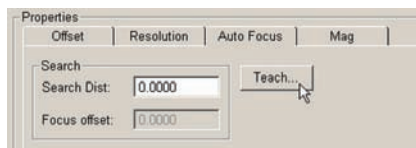

3 You will be instructed to put a calibration artifact in focus. Focus on a circle artifact, position the circle probe over it and click Next.

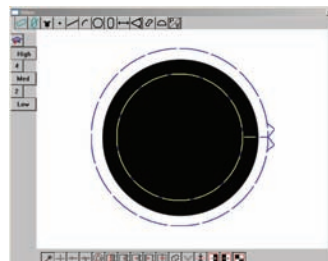
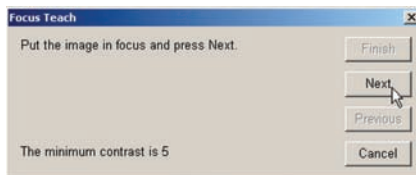

4 You will then be instructed to move the image out of focus. Defocus the image and click Next.

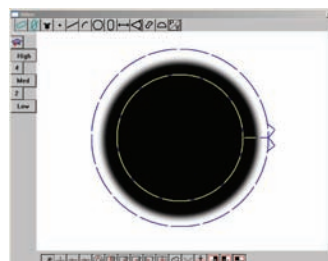
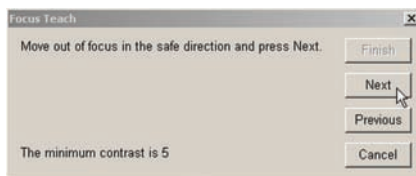

5 The system will perform an auto focus and then instruct you to click Finish to save the search distance for the current magnification. Click Finish to save the search value and conclude the auto focus calibration.

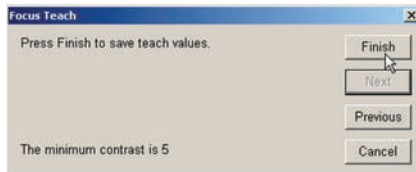

## Calibrating video edge recognition (Teach)

Video edge recognition depends on the contrast between the adjacent light and dark areas that define edges, and must be calibrated (taught) to ensure consistent video measurements.

In most instances, this is a straightforward process of adjusting the lighting and focus to obtain a sharp edge at the highest magnification, and then teaching edge recognition using the Simple tool. However, when the lighting and contrast values change significantly across the required range of magnifications, the process should also include associating light levels with each magnification, as explained earlier in this chapter.

To calibrate video edge recognition:

- 1 Select the highest magnification from the Probe menu or the Probe toolbar.

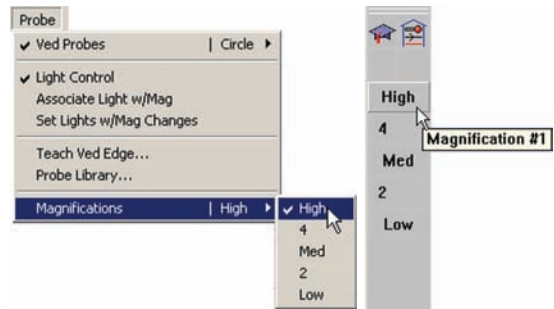

- 2 Adjust the light and focus to obtain a sharp edge and then position the Simple probe across the edge in the appropriate orientation.

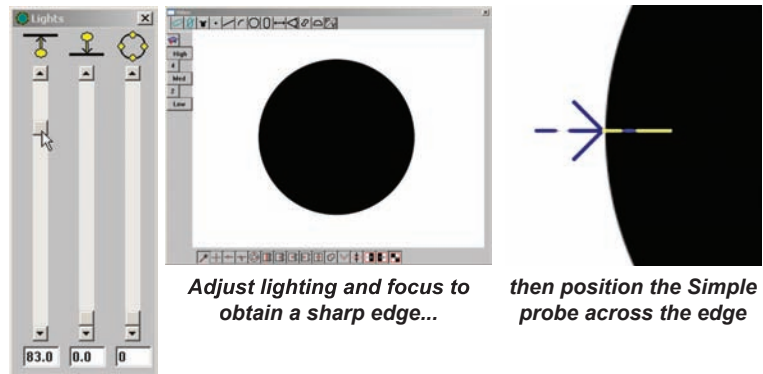

- 3 Click Probe/Teach VED Edge to display the Edge Teach dialog box.

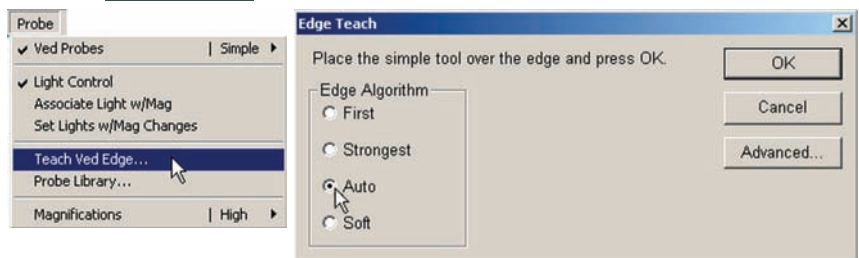

4 In most instances, the Auto algorithm can be selected and provides excellent edge recognition performance. However, some measurement applications might benefit from the selection of one of the other algorithms. Select an edge algorithm by clicking its radio button and then clicking OK.

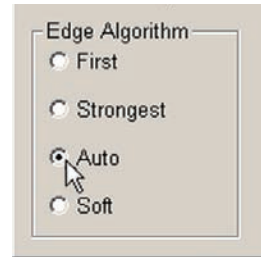

- First** The first edge that meets the system contrast criterion of 50% maximum contrast. This selection is useful when measuring narrow features.
- Strongest** The strongest contrast edge. This selection is useful when conducting measurements in the presence of edge or surface noise.
- Auto** The system evaluates edge data and selects the optimum edge. This selection is the best all-around setting for edge detection.
- Soft** The edge is selected based on contrast criterion specified by the user. The selection is useful when low contrast edges are being measured.

When the Soft edge algorithm is selected, the Soft Edge dialog box will be displayed and a user-defined minimum contrast criterion can be entered that is lower than the system criterion of 50%.

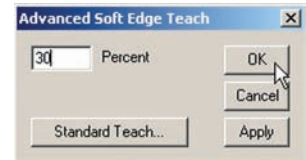

5 Click OK to perform the calibration. A red data point will be shown where the Simple probe crosses the edge.

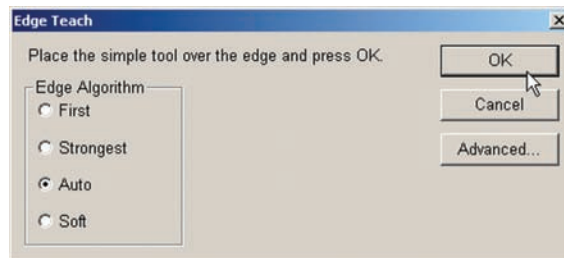

*Click OK to perform the edge calibration...*

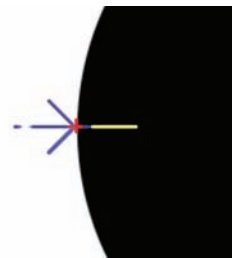

*a red data point will be shown at the edge*

## Advanced Edge Teach

The minimum contrast criteria for the other edge algorithms can be changed from the system default to user-defined values if desired by using the Advanced edge teach functions. Click Advanced to display the Advanced Edge Teach dialog box.

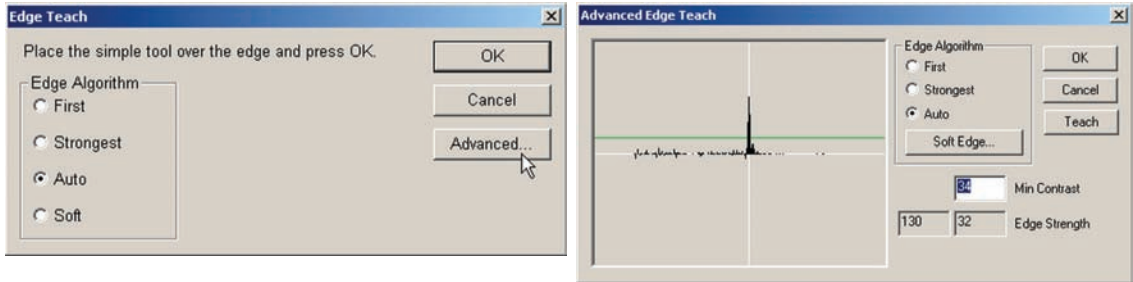

The contrast values of the current edge are shown in the data fields and on the graph of the edge. The low and high edge contrast values are shown in the Edge Strength fields, and the current minimum contrast value for edge recognition is shown in the Min Contrast field and on the graph by a green horizontal line. Clicking the Teach button enters the minimum contrast criterion for the selected edge algorithm into the Min Contrast field.

Typically, the edge criterion entered by the system is adequate to provide excellent edge recognition for most applications. However, the criterion for the selected edge algorithm can be changed by entering a new value into the Min Contrast field and then clicking OK.



## Calibrating pixel resolution

Pixel resolution must be calibrated for each magnification to ensure accurate measurement results. These calibrations are performed as part of the overall initial setup of the video probe system, and should be performed under the following circumstances:

- The first pixel calibration is performed at the highest magnification
- Subsequent pixel calibrations at lower magnifications are performed without adjusting the focus obtained at the highest magnification.

To calibrate pixel resolution:

- 1 Click the Probe/Probe Library menu item to display the probe library, and then click the Resolution tab.

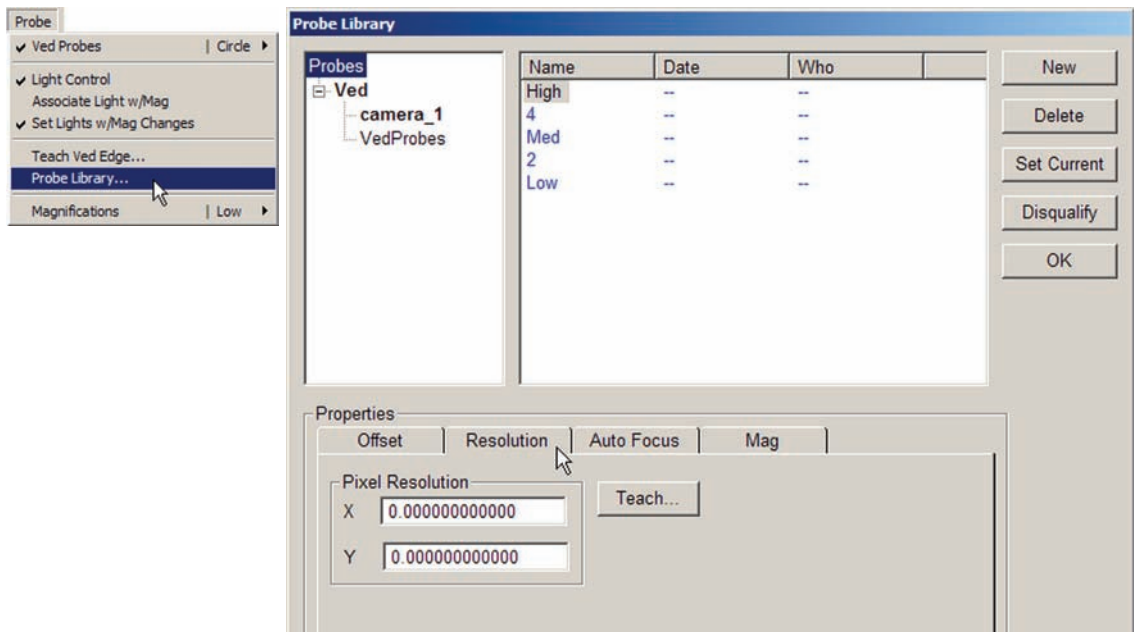

- 2 Select the desired magnification Name and click Set Current.

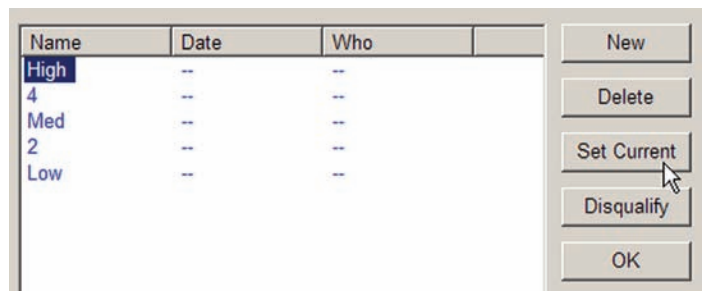

3 Click the Teach button to begin the calibration process. The pixel calibration procedure will use a circle artifact that you provide as a measurement standard. You will be asked to enter the artifact diameter.

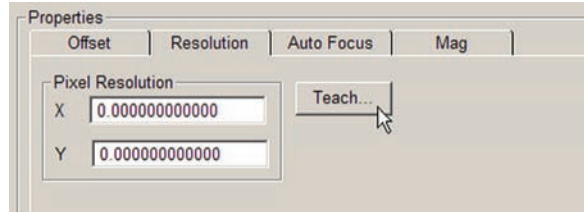

4 Enter the artifact diameter using the current unit of measure and click Continue. In this example, a 1 mm diameter artifact was used. You will be instructed to measure the artifact using the circle probe.

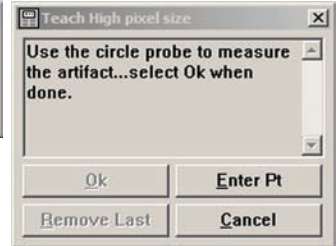
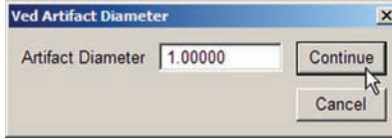

5 Measure the circle artifact and click OK to complete the calibration. The resulting resolution values will be entered into the Pixel Resolution fields.

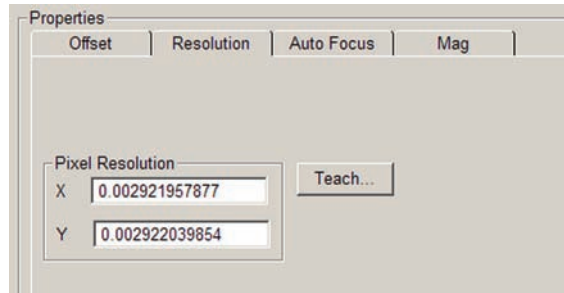
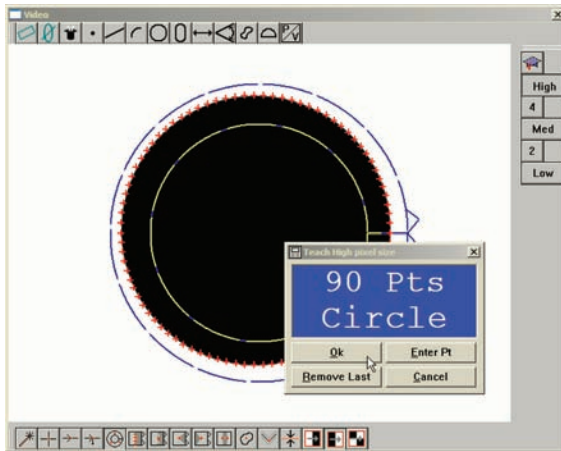

6 Click OK in the Probe Library screen to complete the pixel calibration, or select the next magnification to be calibrated.

## Calibrating offset

Pixel offsets of all lower magnifications must be calibrated against the highest magnification to ensure that specimens remain in the center of the view when switching between magnifications. These calibrations are performed as part of the overall initial setup of the video probe system, and should be performed under the following circumstances:

- The first offset calibration is performed at the highest magnification to establish the calibration magnification standard and time/date stamp the calibration.
- Offset calibrations at lower magnifications are performed after performing all pixel resolution calibrations.
- Offset calibrations at lower magnifications are performed without adjusting the focus obtained at the highest magnification.

To calibrate offset:

- 1 Click the Probe/Probe Library menu item to display the probe library, and then click the Offset tab.

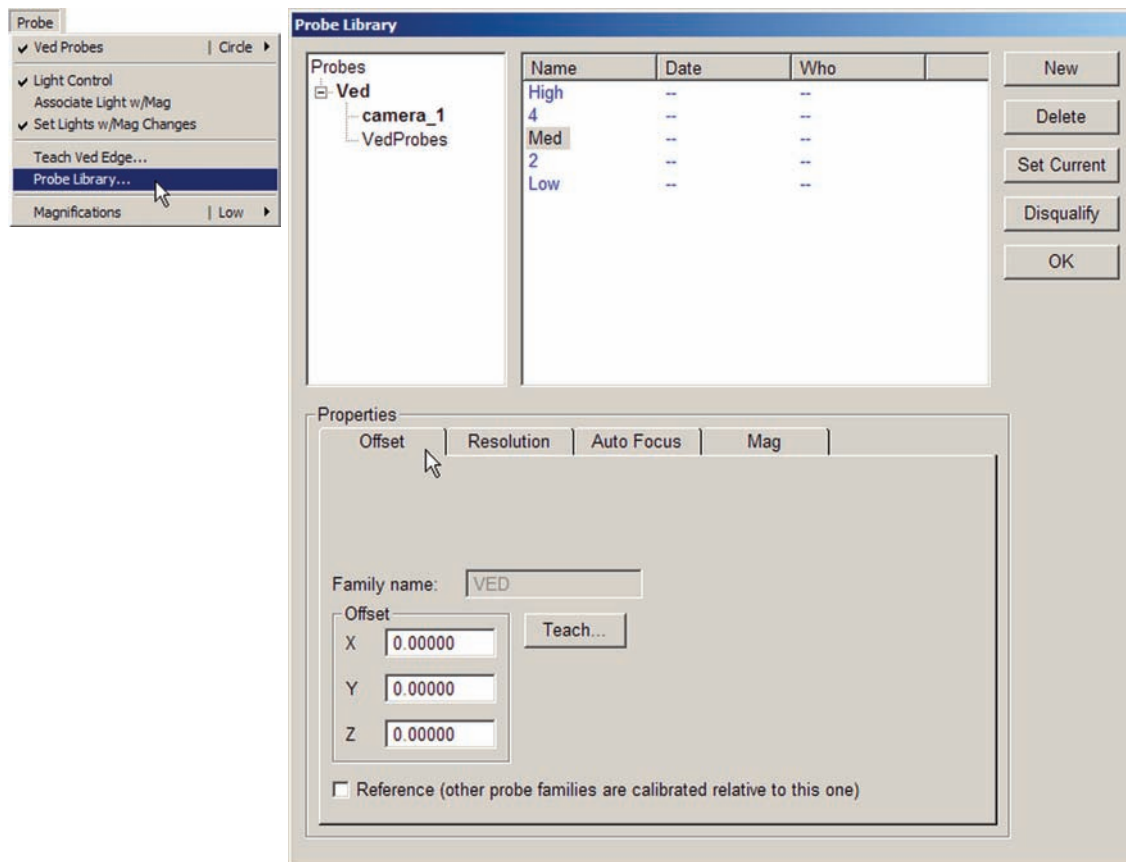

2 Select the desired magnification Name and click Set Current.

The Highest magnification is selected first, and must be defined as the reference for other calibrations. Check the Reference box to define the highest magnification as the reference.

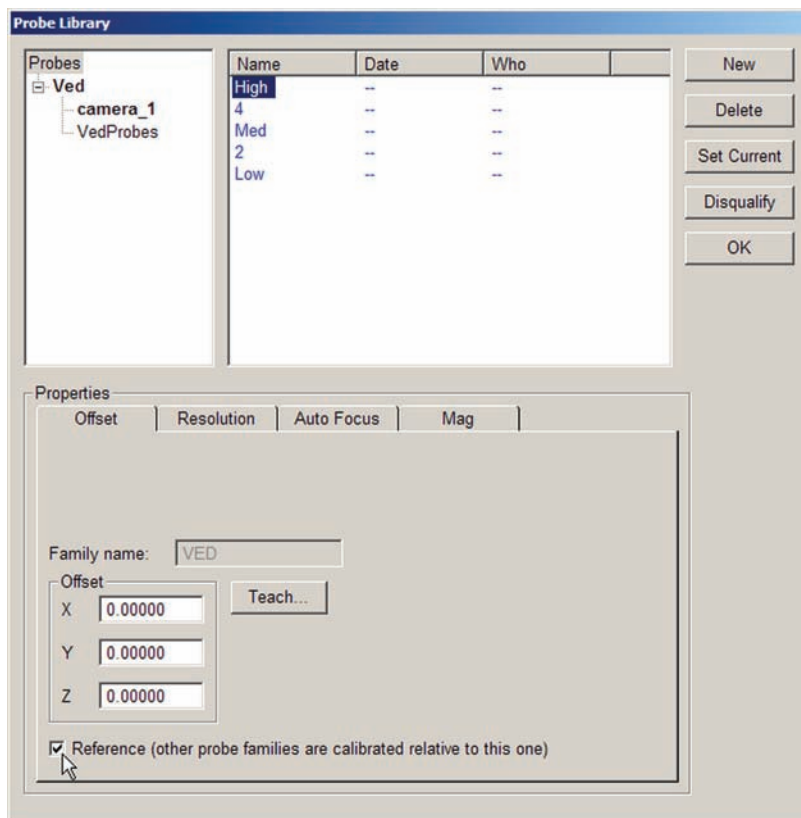

3 Click the Teach button to begin the calibration process. When the Highest (reference) magnification is selected, clicking the Teach button ends the calibration process. When a lower magnification is selected, the calibration process continues. The magnification will be changed to the reference magnification and you will be asked to measure the circle artifact at the highest magnification.

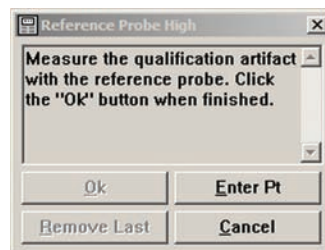

4 Measure the circle artifact and click OK to proceed to the next step in the calibration process. The magnification will be changed back to the one selected for calibration and you will be asked to measure the circle artifact again at the new magnification.

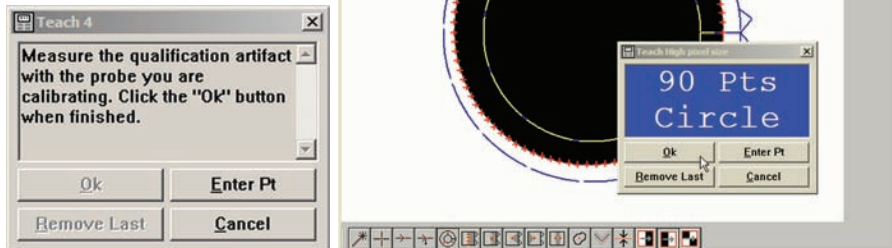

5 Measure the circle artifact again and click OK to complete the offset calibration at the selected magnification. The resulting offset values will be entered into the Offset fields.

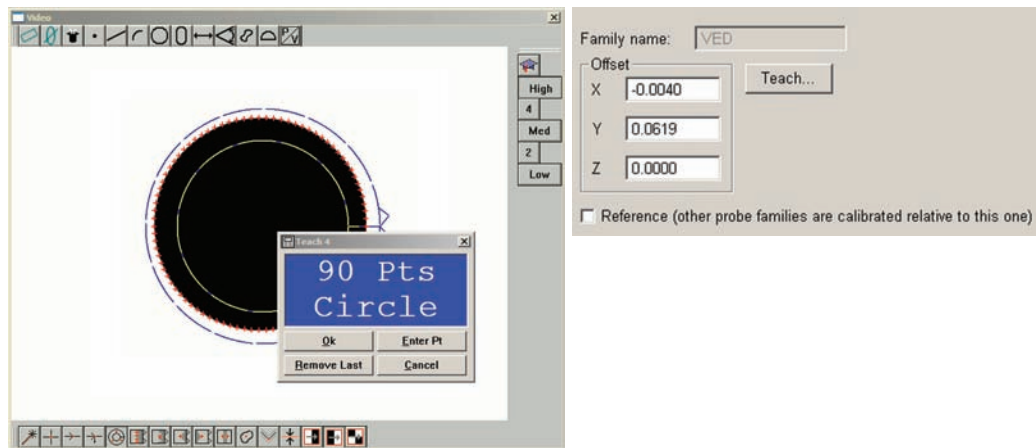

6 Click OK in the Probe Library screen to complete the offset calibration, or select the next magnification to be calibrated.

## Compensating for camera skew

Camera skew is a misalignment of the optical and measurement stage X-Y coordinate systems. The camera skew compensation function measures this misalignment and calculates the compensating angle that will be applied to subsequent measurements to eliminate misalignment inaccuracies. This calibration is performed as part of the overall initial setup of the video probe system, and should be performed only after all calibrations of the highest and lower magnifications have been successfully completed.

To calibrate camera skew:

- 1 Select the lowest magnification from the Probe menu.

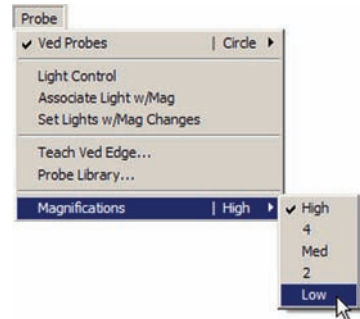

- 2 Click the Probe/Probe Library menu item to display the probe library, and then select Ved to show the camera in the right portion of the Probe Library screen. Make sure the camera is highlighted.

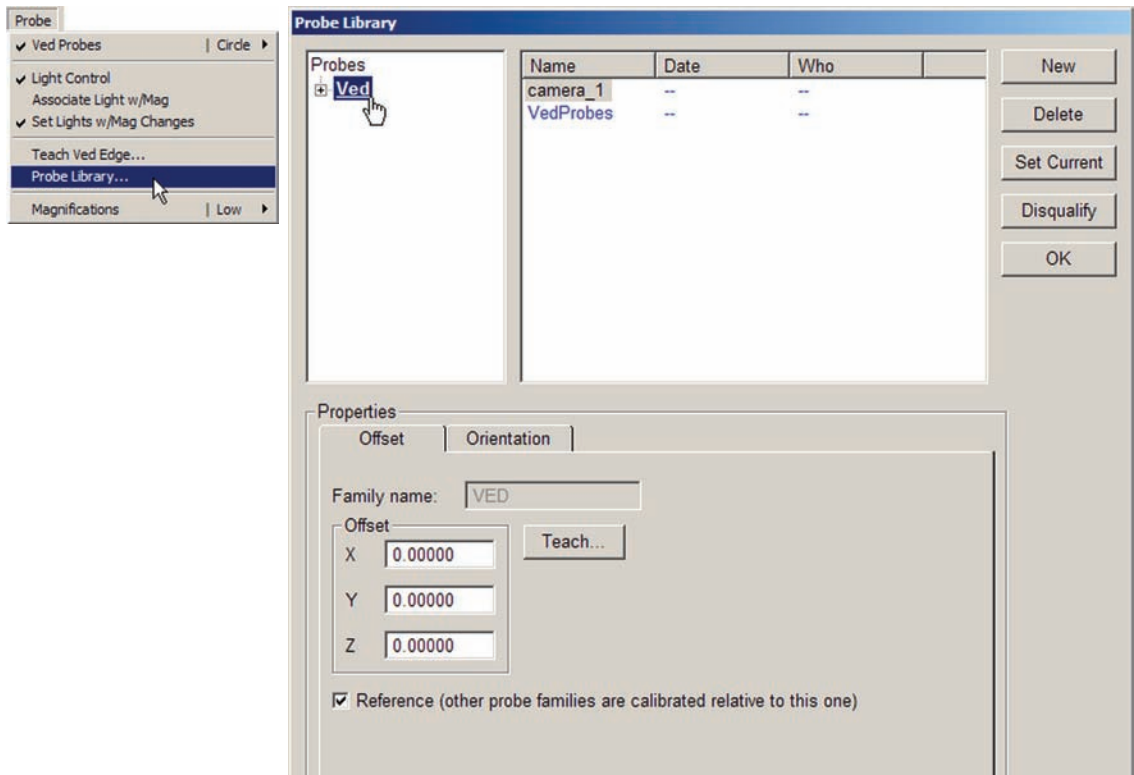

3 Click the Orientation tab to show the Camera Skew data field.

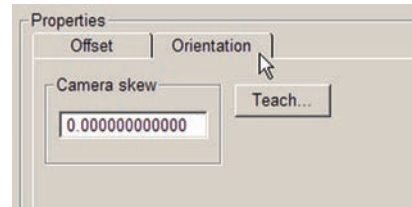

4 Click the Teach button to begin the calibration process. You will be warned that the lowest magnification must be selected as current to perform the camera skew calibration. Click OK to proceed.

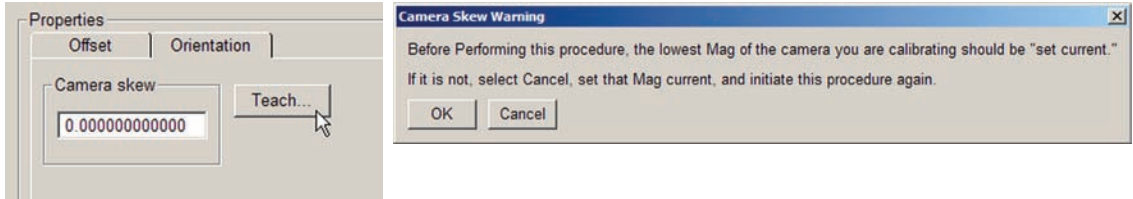

5 You will be instructed to measure a circle artifact on the left side of the live video window. Position the artifact in the approximate center of the left side of the live video window, measure the circle and click

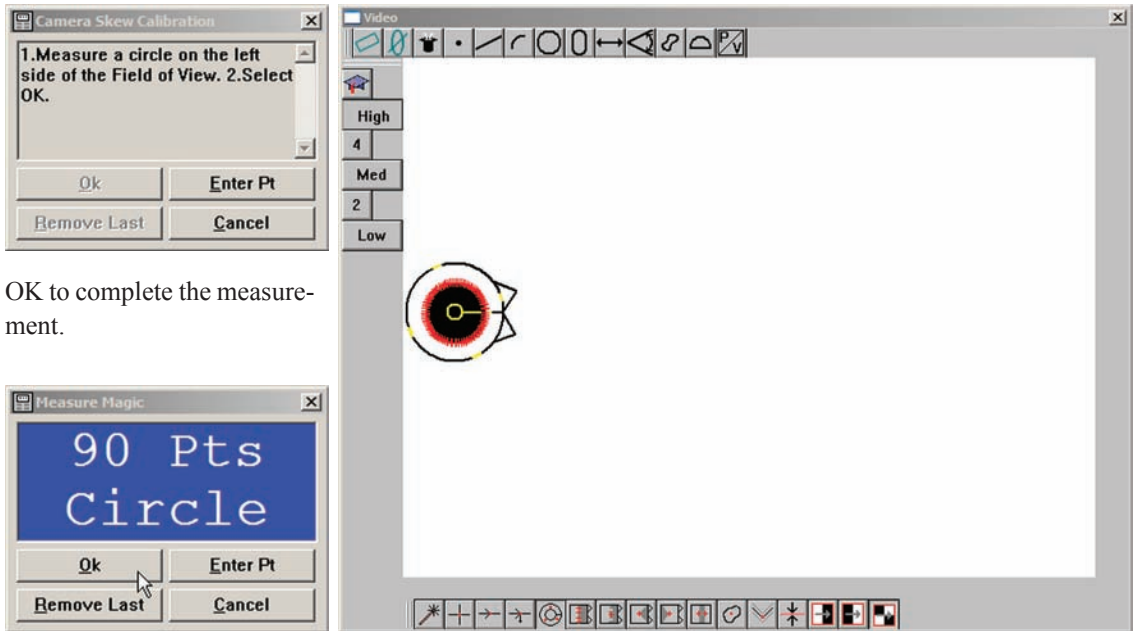

6 You will then be instructed to measure the same circle artifact on the right side of the live video window. Position the artifact in the approximate center of the right side of the live video window by mov-

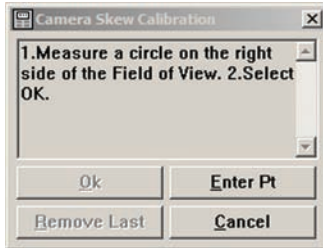

ing the stage in the X-axis, measure the circle and click OK.

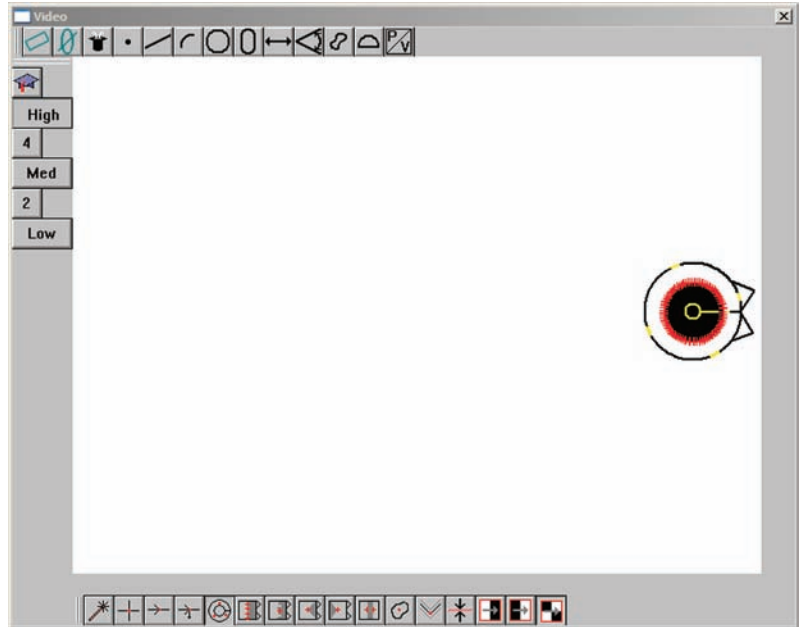

#### CAUTION

Allow the stage to move on only the X-axis. Movements on the Y-axis will result in camera skew calibration errors.

The resulting compensation value will be entered into the Camera skew data field.

7 Click OK in the Probe Library screen to complete the camera skew compensation.

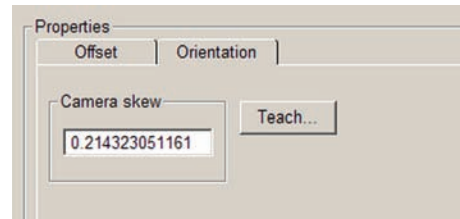

#### CAUTION

Camera skew should be less than 1.00 degrees. If the value of camera skew is 1.00 degree or more, seek the assistance of a qualified optical technician for mechanical system adjustments. Do not attempt to make mechanical adjustments to the optical system yourself.



## Configuring video probe data collection parameters

Video probe data collection parameters include the maximum number of scans generated or points collected when fired, distribution of points collected by circle probes and the minimum distance between points collected by the worm probe. Not all video probes have parameters that are configurable. Video probe configurations are listed below.

Video Probe	Configurable parameter
Average	Max scans when fired to return a single point
Blob	Not applicable
Buffer	Max points returned when fired
Capture	Not applicable
Circle	Max points returned when fired, or the distribution of two returned points
Crosshair	Not applicable, always one scan to return one point
Farthest	Max scans when fired to return a single point
Height	Max scans when fired to return a single point
Nearest	Max scans when fired to return a single point
Pattern	Max points returned when fired
Simple	Not applicable, always one scan to return one point
Video charts	No points are returned, charts are only used for visual inspections
Width	Max scans when fired to return two points
Worm	Max points returned when fired and the minimum distance between points



**NOTE**

Detailed information regarding the use and configuration of video probes is contained in **Chapter 5: Measuring**.

To configure the data collection for a video probe:

- 1 Click the Probe/Probe Library menu item to display the probe library, and then select Ved Probes to show the video probes in the right portion of the Probe Library screen.

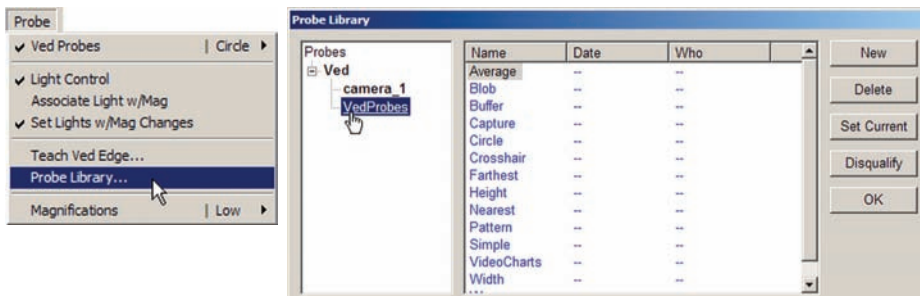

2 Select the desired probe from the list of probes. The probe's data collection parameters will be located on the bottom portion of the screen. Change the data collection parameter if necessary by entering a new value into the data field and then clicking OK.

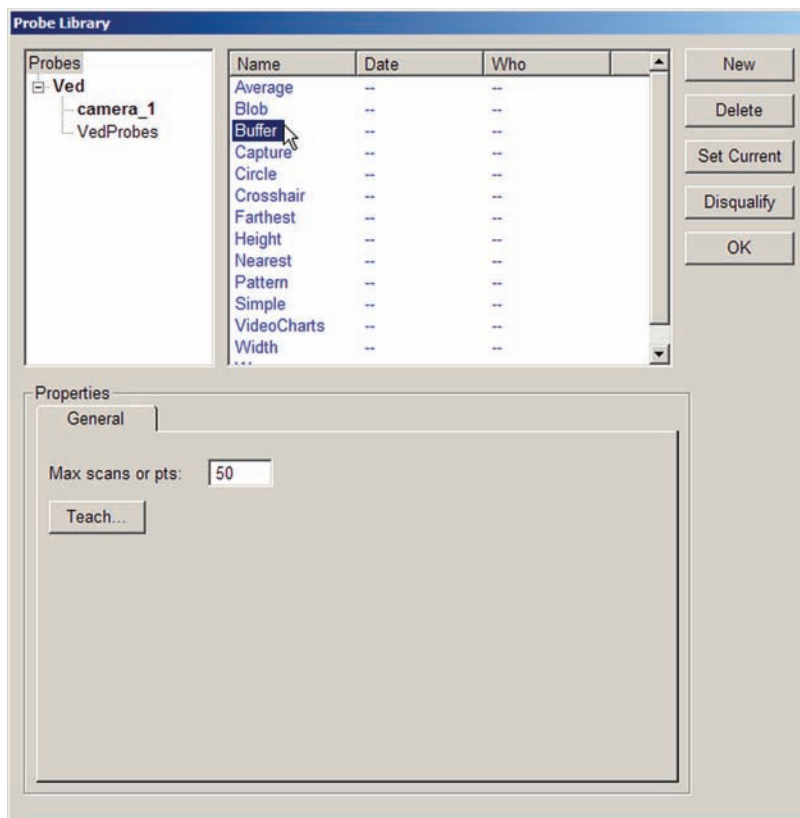

# Chapter 5:

# Measuring

Measurements can be conducted using video edge detection on manually controlled systems, or on automated CNC systems. Features can be probed manually by the user, or automatically under program control. The measurement of features can be limited to probing points, or might require the construction or creation of new features in addition to probing. However measurements are conducted, the fundamental measurement process and the tools required to perform measurements remain unchanged. Here's what you'll find in this chapter:

Measurement activities .....	138
The measurement workspace .....	138
The measurement process .....	138
Preparing to use video probes .....	139
Establishing the measurement reference.....	139
Probing and measuring features.....	144
Measure Magic.....	144
Probing features .....	144
Probing specific feature types.....	146
Points .....	146
Lines .....	147
Arcs.....	148
Circles.....	149
Slots .....	151
Distances.....	152
Angles.....	153
Blobs.....	155
Profile measurements.....	156
Constructing features .....	172
Point constructions.....	173
Line constructions.....	178
Distance constructions.....	185
Circle constructions .....	191
Arc constructions .....	194
Angle constructions .....	195
Creating features .....	196

## Measurement activities

QC5200 measurement sessions can include one or all of the following activities:

- Establishing a measurement reference
- Probing and measuring features
- Constructing features
- Creating features

## The measurement workspace

The recommended minimum workspace configuration for performing measurements and other activities described in this chapter includes the:

- DRO window
- Features template
- Results window
- Part View window
- Live Video window



### NOTE

Workspaces are described in detail in [Chapter 2: User Interface](#).

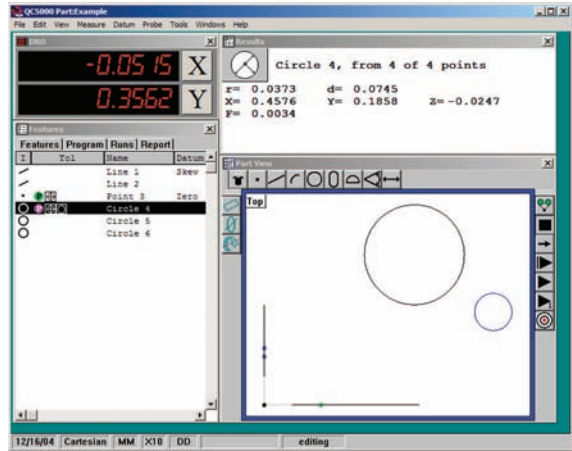

## The measurement process

The basic measurement process shown here is identical for all feature types. The details of individual measurement steps are described in the remaining pages of this section.

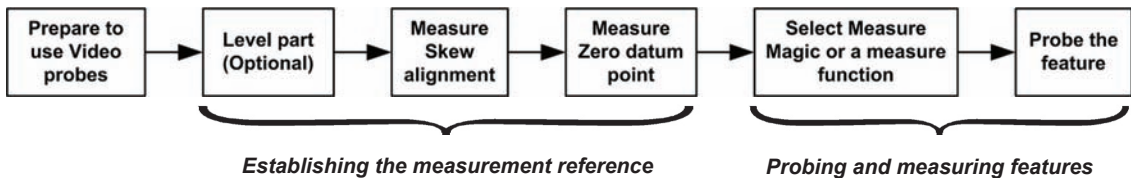

## Preparing to use video probes

The system stage and optical system must be well-maintained, free of scratches and other damage and clean. The optical magnification and part lighting must be prepared as described in [Chapter 4: Probes](#).

## Establishing the measurement reference

A reliable measurement reference must be established before part features can be probed and measured. This reference will be created by the user and will ensure:

- A level part surface
- Precise part alignment
- An origin or datum zero for the measurement coordinate system

### Leveling the part (optional)

When the surface plane of the part is not orthogonal to the measuring axis, small cosine errors can be generated during the measuring process. These errors can be minimized or eliminated by leveling the part.



#### CAUTION

This is not required in most well-maintained systems. Additionally, if the depth of field of the lens system is not much less than the level error, no benefit can be gained from leveling the part.

To level the part:

- 1 Click the Datum/Level menu item. A description of the leveling measurement process will be displayed in a prompt window.
- 2 Perform the leveling measurement by probing 3 or more points that are well distributed across the surface of the part using the Height probe, and then click OK in the prompt window.

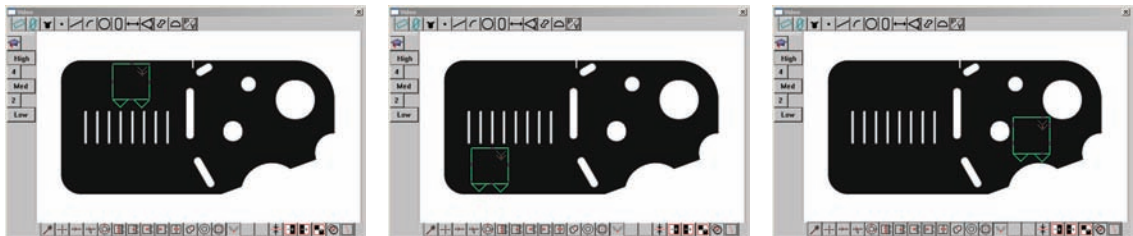
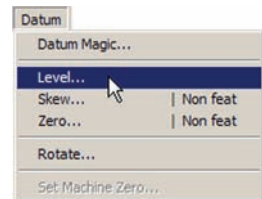

*Three points of the Metronics quickie slide are probed to perform part leveling*

The level plane feature will be added to the Features template.

### Creating a skew alignment

When the part is misaligned (twisted) in the X-Y plane, small cosine errors can be generated during the measurement process.

These errors can be eliminated by creating a skew alignment for the part. The skew alignment includes a precise measurement of the part misalignment. Once the misalignment is known to the system, subsequent feature measurements are automatically compensated to eliminate cosine errors. Measurement data in the Results window and feature images in the Part View window will reflect measurements of a perfectly aligned part.

To create a skew alignment:

1 Click the Datum/Skew menu item. A description of the skew alignment process will be displayed in a prompt window.

2 Perform a skew alignment by probing 2 or more points well distributed along the entire length of the desired part reference edge, and then click OK in the prompt window.

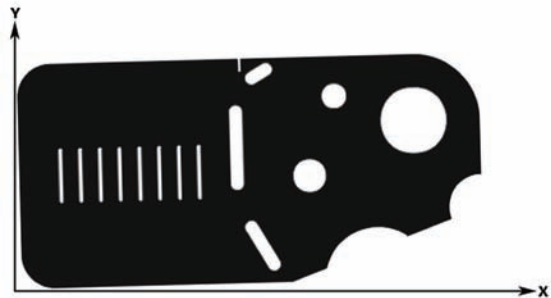
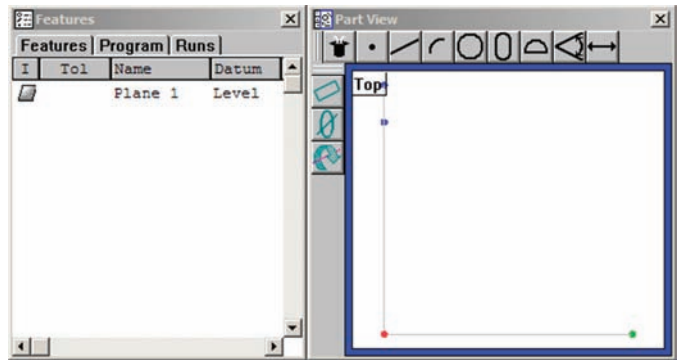

*A part misaligned in the X-Y plane*

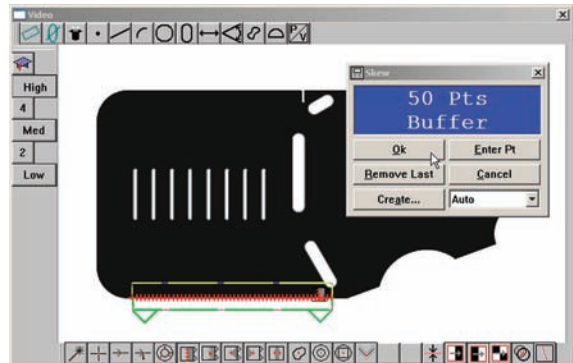
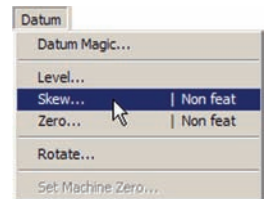

*The bottom edge of the part is probed with the Buffer probe to perform skew alignment on the x-axis*

The skew line feature will be added to the Features template and shown in the Part View window.

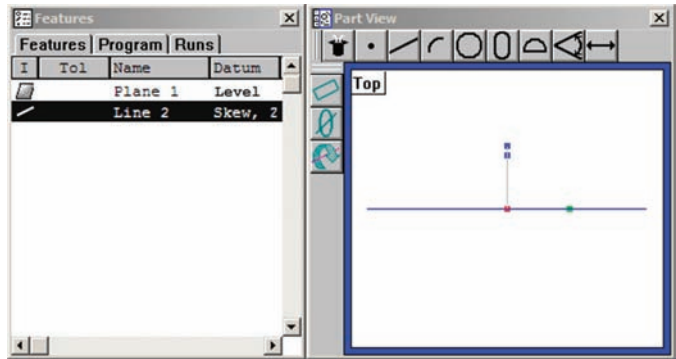

### Creating a datum zero point

Creating the datum zero point is the final step in establishing a valid Cartesian or polar coordinate system for subsequent measurements. The datum zero point will be used as the origin of Cartesian or polar systems. The datum zero point can be positioned in any location that satisfies the measurement requirements of the user. The datum zero point can be created by probing a point, or by constructing a point from parent features.

### Probing a datum zero point

The datum zero point can sometimes be created directly by probing a point. Simple probing is more often possible when the part is precisely aligned in the stage.

To probe a datum zero point:

- 1 Select the crosshair probe if necessary by clicking the Probe/Crosshair menu item.
- 2 Click the Datum/Zero menu item. A description of the datum zero measurement process will be displayed in a prompt window.
- 3 Create the datum zero point by probing the desired point, and then click OK in the prompt window.

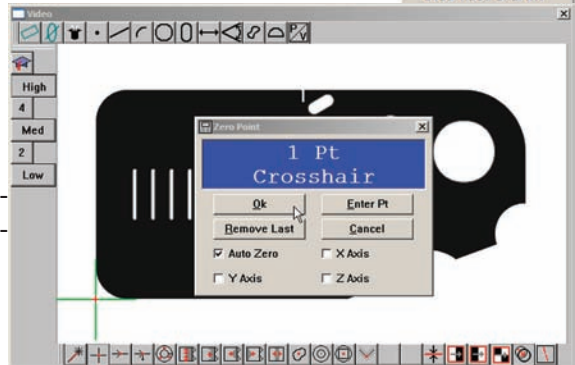
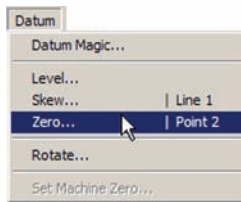
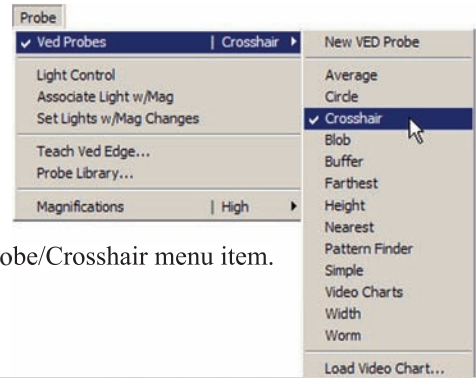

The intersection of X and Y axes is probed with the crosshair probe to perform a Datum zero

The datum zero point will be added to the Features template and the coordinate system graphic will be completed in the Part View window.

### Constructing a datum zero point

The datum zero point can be constructed from parent features when simply probing the desired point is not possible.

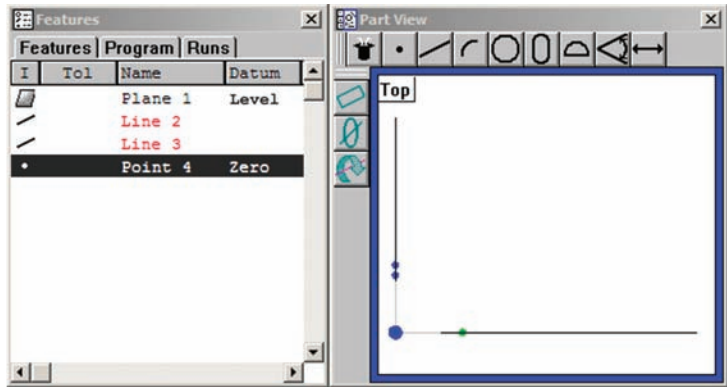

It would not be possible to provide a single description of this process for all measurement applications that require feature constructions to create a datum zero point. However, the concept illustrated by the example included here and the construction techniques described later in this chapter can be used to create a datum zero point for any measurement application.

In this example, a datum zero point is constructed at the intersection points of the X-axis along the bottom of the part (skew axis), and the Y-axis along the left side of the part. This point could not be probed directly because the left bottom corner includes a radius, and the part is misaligned in the stage. Errors resulting from the misalignment have already been eliminated by creating a skew alignment along the bottom of the part. The datum zero point will be constructed from the X (skew) and Y part axes.

To construct the datum zero point:

- 1 Click Measure Magic or the Measure/Line menu item. A description of the line measurement process will be displayed in a prompt window
- 2 Probe 2 or more points well distributed along the entire left side of the part, and then click OK in the prompt window.

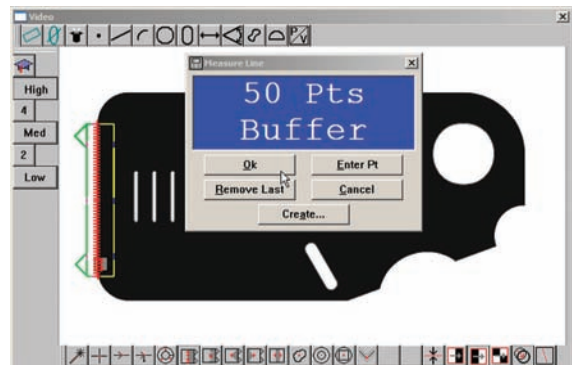
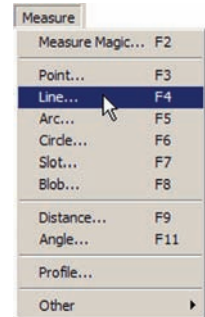

*The left edge of the part is probed with the Buffer probe to acquire a line for the construction of a datum zero*



The line feature will be added to the Features template and shown in the Part View window.

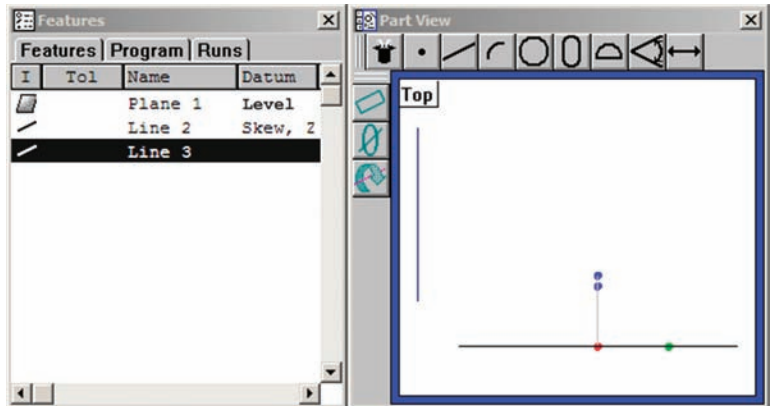

3 Select the new line and the skew line in the Features template (the X and Y part axes).

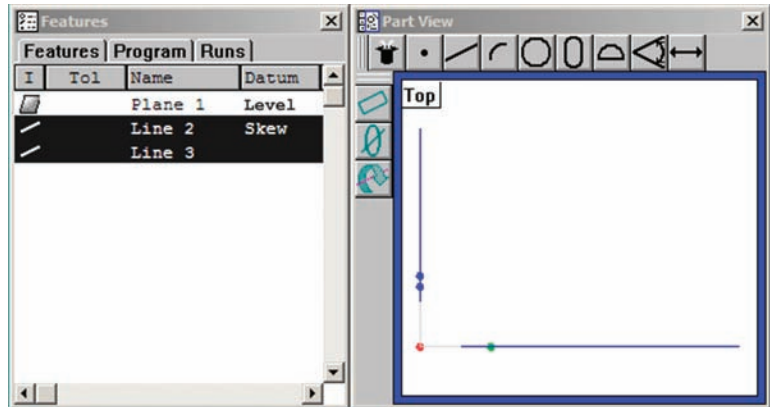

4 Click the Datum/Zero menu item. The datum zero point will be constructed at the intersection of the two lines, and will be shown in the Features template and in the Part View window.

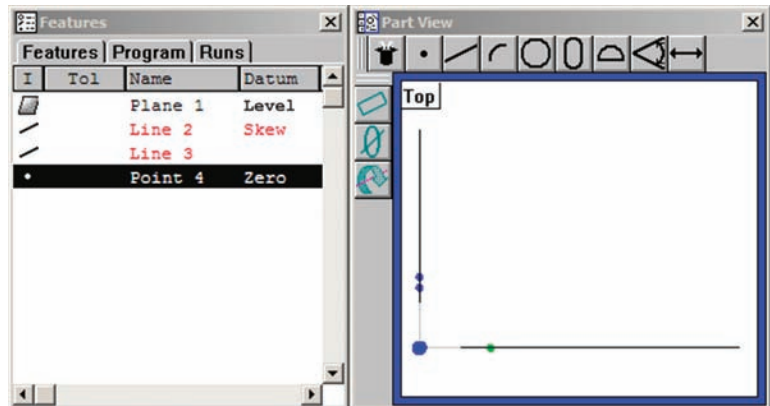
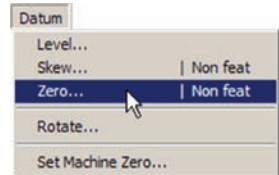

## Probing and measuring features

Part features are measured by creating a part datum, and then by probing and collecting points that define the feature's shape and location. Feature points can be probed using Measure Magic or by using a specific measurement function such as the line or circle function.

### Measure Magic

Measure Magic analyzes feature data collected by part probing and automatically determines the feature type. Measure Magic supports the following feature types in the QC5200:

- Points
- Lines
- Circles
- Arcs

When Measure Magic is used, and more than the minimum number of points required to classify a feature are acquired, the feature type can be changed manually by the user if necessary. However, when a specific measure function is used to probe feature data, the feature type cannot be changed.

### Probing features

The feature probing process is essentially the same for all feature types, and is shown below:

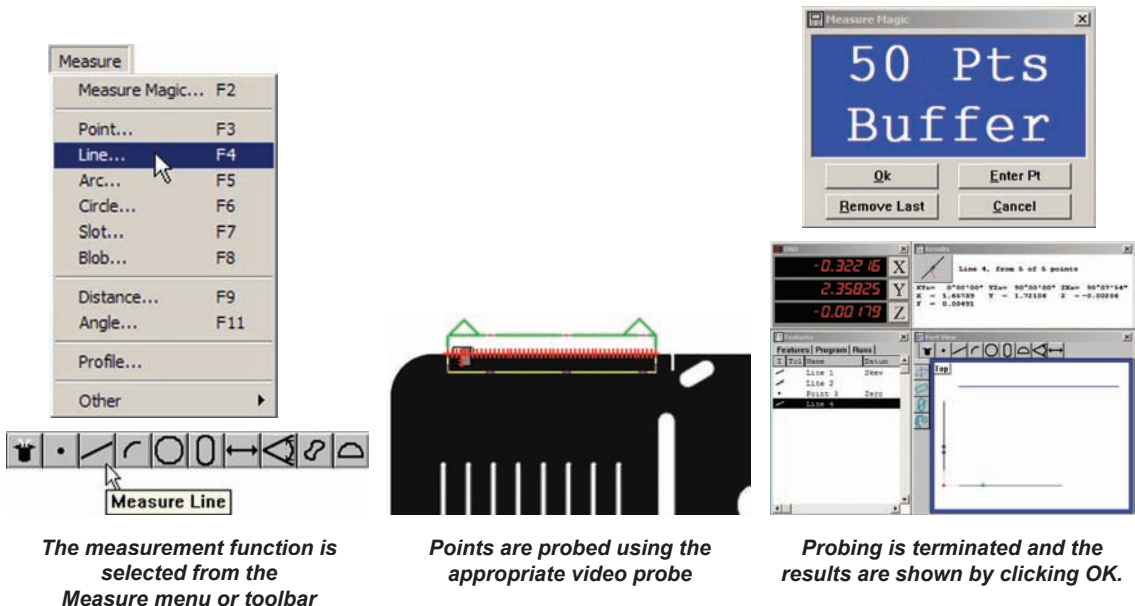
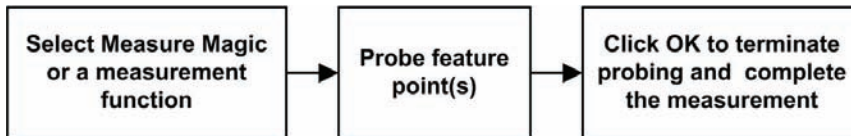

The following feature measurements are supported by the QC5200:

- Points
- Lines
- Arcs
- Circles
- Slots
- Distances
- Angles
- Profiles
- Blobs

Features can be probed manually or automatically as part of a program using video edge detection in systems that include CNC stages.



**NOTE**

Manual probing is discussed in Chapter 4: Probes. Automatic probing is discussed in Chapter 8: Programming.

## Probing specific feature types

While the probing process is essentially the same for all feature types, the minimum number of points required and the geometric placement of these points are different. The unique requirements for probing each specific feature type are described in the remainder of this section.

### Points

A minimum of one probed point is required to measure a point. Multiple points can be probed if the feature location is indistinct and it is considered a benefit to use the geometric average of many locations.

When a single point is probed, Measure Magic will correctly recognize a point feature. However, when multiple points are probed, it is possible that Measure Magic will assign the wrong feature type to the data. If the wrong feature type is assigned, it can easily be changed by right-clicking the Results window and selecting the point feature alternative.

Measurement results are shown in the Features template, Part View window and Results window. The Results window shows the feature identification number, the number of points used in the measurement, the coordinate location of the point and the form error. When only one point is probed, the form error is zero. When multiple points are probed, the form error is the sum of error magnitudes of opposite polarities.



**A single point is probed to measure the location of a point feature**

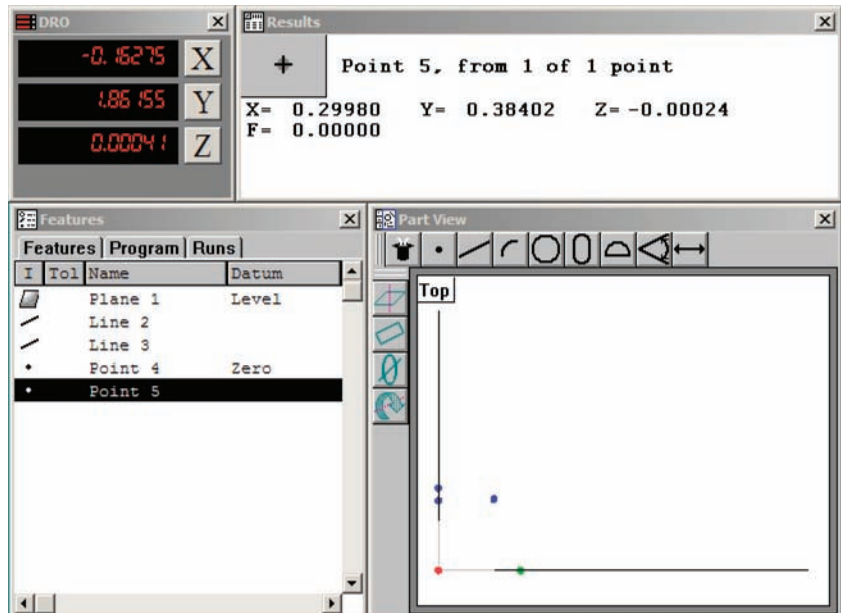
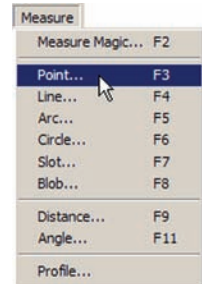

**Lines**

A minimum of two probed points is required to measure a line. There is no practical limit to the number of points that can be probed, and in general accuracy is increased by probing more points.

A best-fit algorithm is used to define the line when more than two points are probed. The line fit to the probed data can easily be changed by right-clicking the Results window and selecting the desired fitting algorithm. Please refer to [Appendix C: Data Fitting Algorithms](#) for details regarding the fitting algorithms.

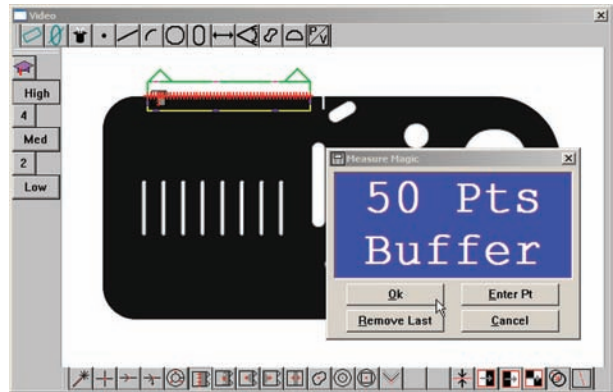
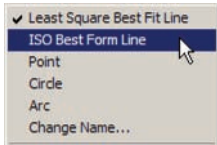

*Fifty points are probed using the Buffer probe to measure a line feature*

Measurement results are shown in the Features template, Part View window and Results window. The Results window shows the feature identification number, the number of points used in the measurement, the angular orientation of the line, the coordinate location of the center of the line and the form error. When only the two required points are probed, the form error is zero. When more than two points are probed, the form error is the sum of the two greatest opposing error magnitudes.

Click the feature stamp icon in the left corner of the Results window to display the Feature Stamp window. The line will be shown with data point form errors in blue, filtered points in yellow and the greatest two opposing form errors in red.

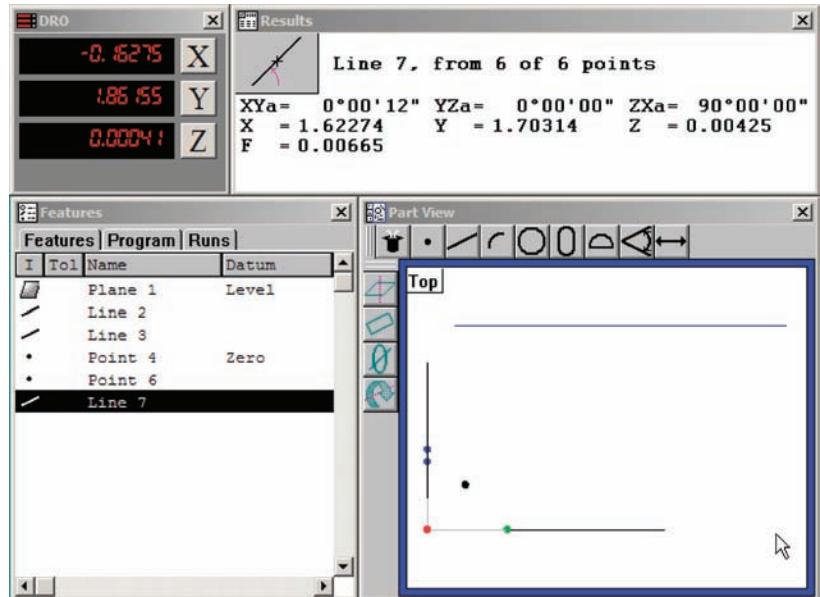
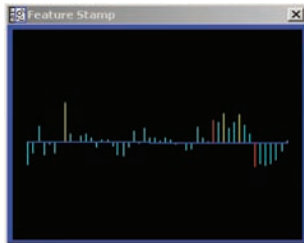

## Arcs

A minimum of three probed points is required to measure an arc. There is no practical limit to the number of points that can be probed, and in general accuracy is increased by probing more points.

When the arc is less than 185 degrees, Measure Magic will correctly recognize the arc feature. However, when the arc is 185 degrees or more, it is likely that Measure Magic will

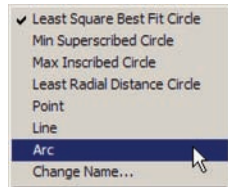

assign the circle feature type to the data. If the wrong feature type is assigned, it can easily be changed by right-clicking the Results window and selecting the arc feature alternative.

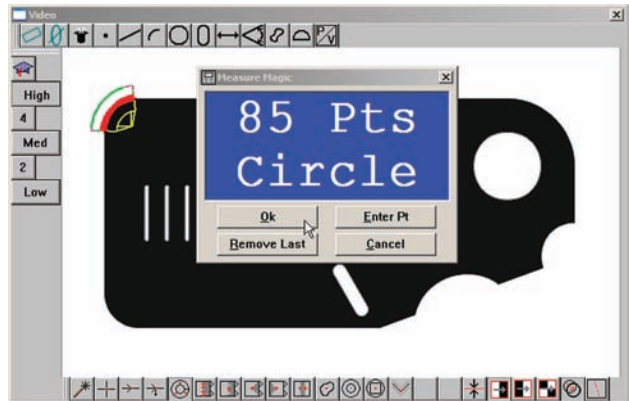

*Eighty five points are probed using the Circle probe to measure an arc feature*

Measurement results are shown in the Features template, Part View window and Results window. The Results window shows the feature identification number, the number of points used in the measurement, the radius, diameter and length of the arc, the coordinate location of the center of the arc and the form error. When only the three required points are probed, the form error is zero. When more than three points are probed, the form error is the sum of the two greatest opposing error magnitudes.

Click the feature stamp icon in the left corner of the Results window to display the Feature Stamp window. The arc will be shown with data point form errors in blue, filtered points in yellow and the greatest two opposing form errors in red.

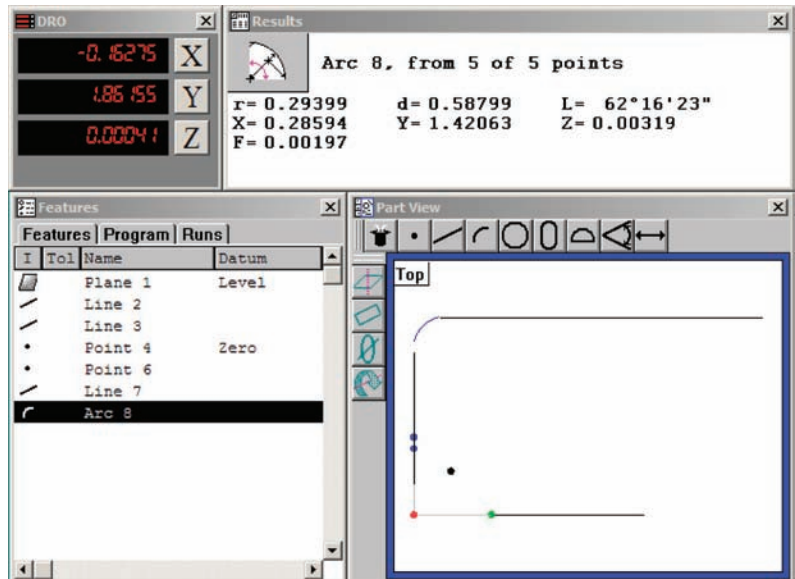
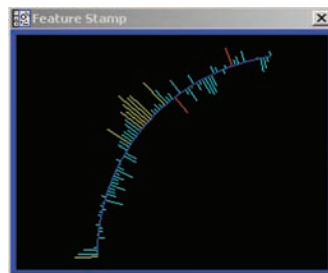

### Circles

A minimum of three probed points is required to measure a circle. There is no practical limit to the number of points that can be probed, and in general accuracy is increased by probing more points.

When 185 degrees or more of the circle is probed, Measure Magic will correctly recognize the circle feature. However, when less than 185 degrees is probed, it is likely that Measure Magic will assign the arc feature type to the data. If the wrong feature type is assigned, it can easily be changed by right-clicking the Results window and selecting the circle feature alternative.

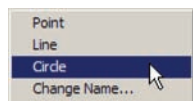

*Ninety points are probed using the Circle probe to measure a circle feature*

A best-fit algorithm is used to define the circle when more than three points are probed. The circle fit to the probed data can easily be changed by right-clicking the Results window and selecting the desired fitting algorithm. Please refer to [Appendix C: Data Fitting Algorithms](#) for details regarding the algorithms.

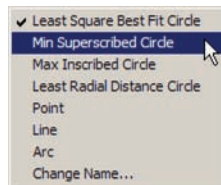

Measurement results are shown in the Features template, Part View window and Results window. The Results window shows the feature identification number, the number of points used in the measurement, the radius and diameter of the circle, the coordinate location of the center of the circle and the form error. When only the three required points are probed, the form error is zero. When more than three points are probed, the form error is the sum of the two greatest opposing error magnitudes.

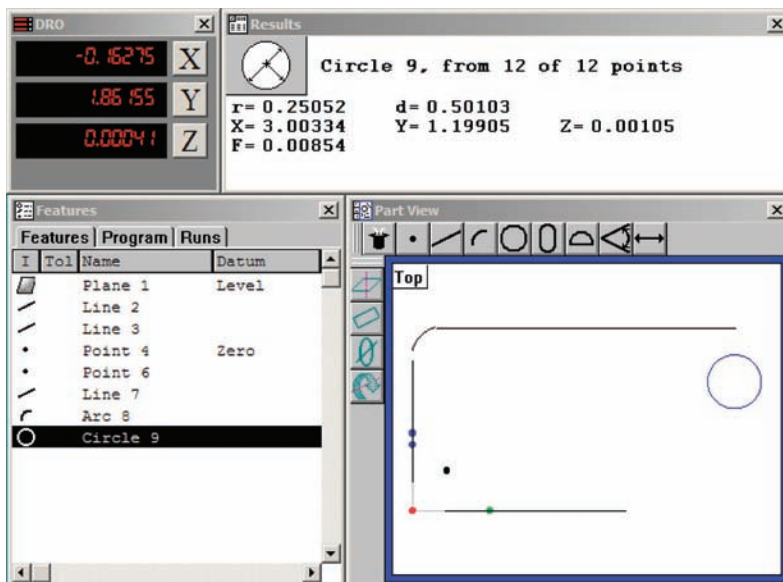

Click the feature stamp icon in the left corner of the Results window to display the Feature Stamp window. The circle will be shown with data point form errors in blue, filtered points in yellow and the greatest two opposing form errors in red.

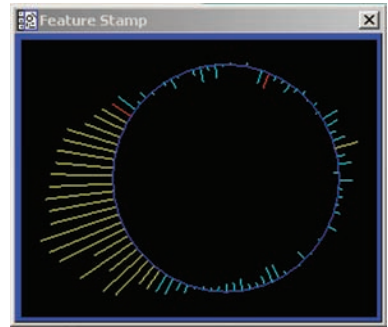



**Slots**

Five probed points are required to measure a slot. The five points must be located in a prescribed pattern, and must be probed in clockwise or counterclockwise order.

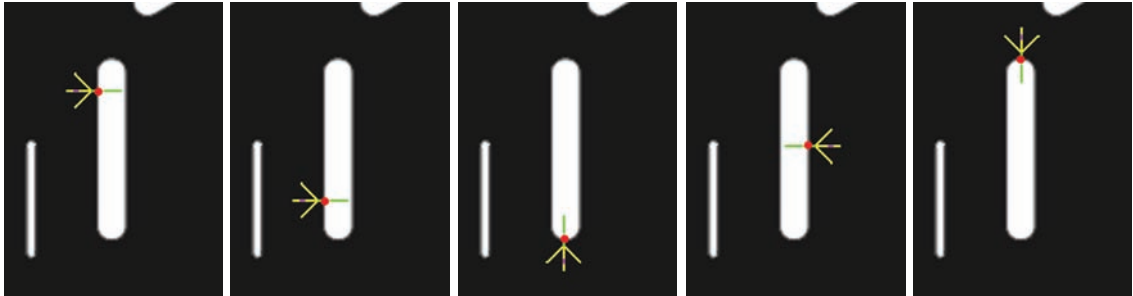

*A slot is probed using the Simple probe in the required pattern of five positions, in counterclockwise order*

As shown above, the correct pattern of points probed around the slot is:

- Two points well distributed along one long side, followed by
- One point on the closest end, followed by
- One point on the approximate center of the second long side, followed by
- The last point on the remaining end



**CAUTION**

**Probing a different pattern of points, or probing out of either clockwise or counterclockwise order will result in erroneous slot measurements.**

Measurement results are shown in the Features template, Part View window and Results window. The Results window shows the feature identification number, the number of points used in the measurement, the length, width and angular orientation of the slot, and the coordinate location of the center of the slot.

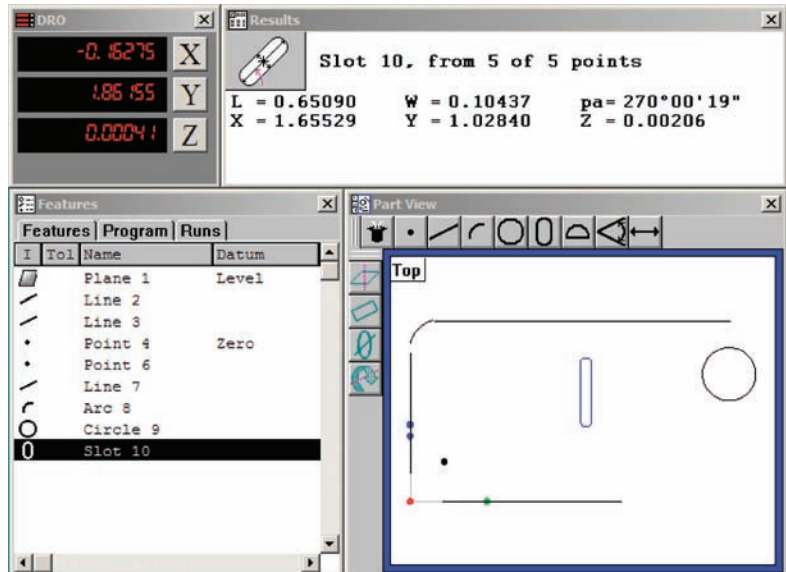

## Distances

Two probed points are required to measure a distance.



*The distance across five slots is measured by probing two points using the Simple probe*

Measurement results are shown in the Features template, Part View window and Results window. The Results window shows the feature identification number, the number of points used in the measurement, the length of the distance, and the coordinate location of the center of the distance.

The vector direction of the distance from beginning to end is shown in the Part View and Feature Stamp windows as a dot at the end of the distance.

**DRO**

-0.45275 X  
4.86455 Y  
0.00041 Z

**Results**

Distance 11, from 2 of 2 points

L= 1.08164  
X= 1.08163    Y= 0.00000    Z= 0.00386

**Features**

I	ToI	Name	Datum
		Plane 1	Level
		Line 2	
		Line 3	
		Point 4	Zero
		Point 6	
		Line 7	
		Arc 8	
		Circle 9	
		Slot 10	
		Distance 11	

**Part View**

Top

Feature Stamp

**Angles**

Four probed points are required to measure an angle. The four points must be located in a prescribed pattern, on the two lines that form an angle. There is no practical limit to the number of points that can be probed, and in general accuracy is increased by probing more points.

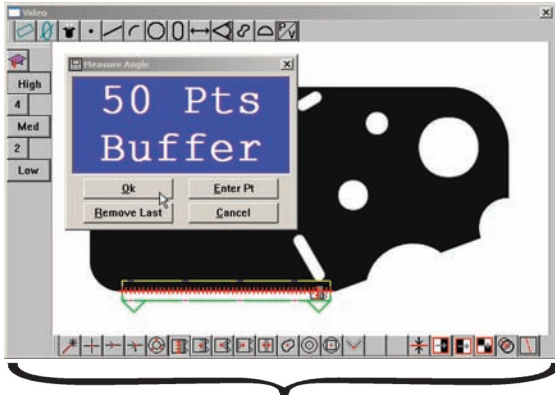

*Fifty points are probed using the Buffer probe on the reference side...*

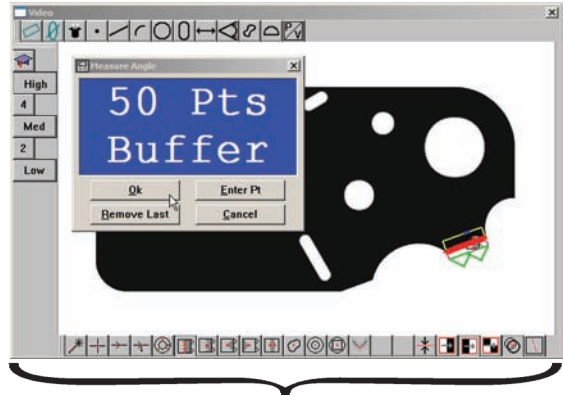

*then fifty points are probed using the Buffer probe on the other side of the included angle*

As shown above, the correct pattern of points probed for an angle is:

- Two points well distributed along the reference side, followed by
- Two points well distributed along the other side of the included angle

Measurement results are shown in the Features template, Part View window, Results window and Feature Stamp window. The Results window shows the feature identification number, the number of features used in the measurement, the included angle and the coordinate orientation of the angle.

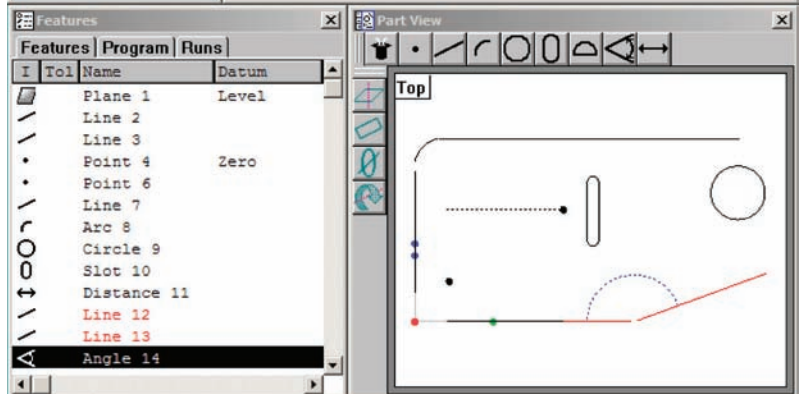
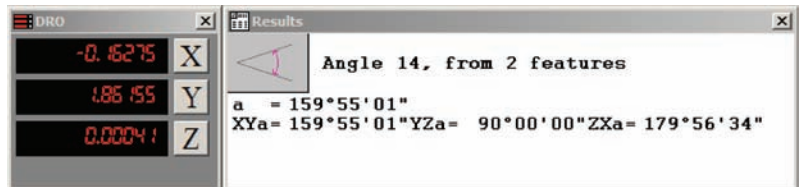

The included angle is shown as the default measurement result, however, the angle type can easily be changed by right-clicking the Results window and selecting the desired angle.

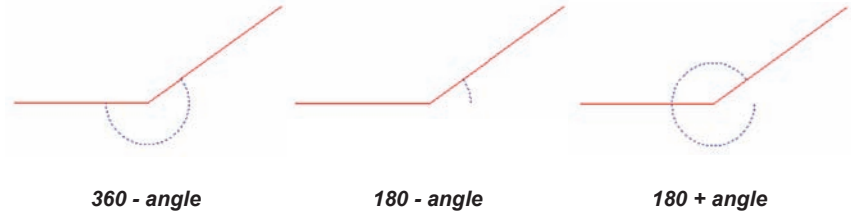
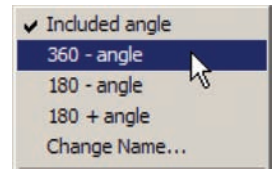

**Blobs**

The Blob probe is fired over features to acquire points for the measurement of regular and irregular shapes.

Measurement results are shown in the Features template, Part View window and Results window. The Results window shows the feature identification number, the number of points used in the measurement, the geometric center location of the feature, the area of the feature, the maximum and minimum distances across the area, the circumference (or perimeter) of the feature.



*One hundred and forty eight points are acquired by the Blob probe to measure a solder pad*

## Profile measurements

Profile measurements compare part features acquired by probing to nominal part profiles from drawing or part data files. Measured features and nominal profile features are shown in the Measure Profile window.

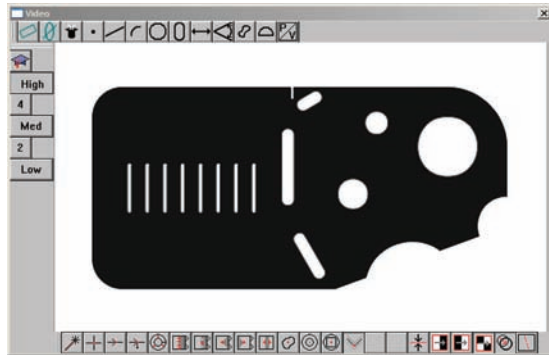

**Part shown in the Live Video window**

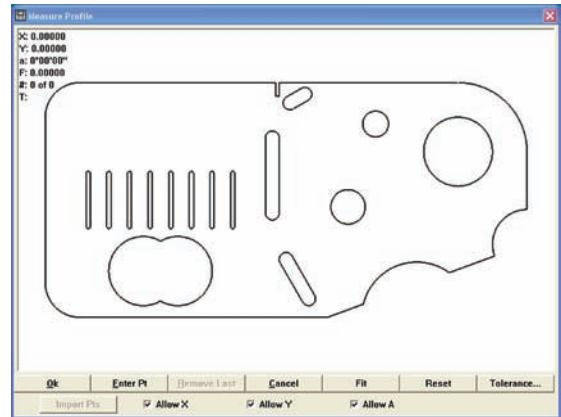

**Nominal profile shown in Measure Profile Window**

The nominal profile in the Measure Profile window can be imported from a drawing file in .IGS or .DXF formats, or as a collection of features from the Features template.

As features are measured, their points can be displayed in the Measure Profile window. When the desired points have been probed, a Fit operation can be performed. During the Fit operation, the system superimposes the measured data over the nominal profile and adjusts the X, Y and rotational orientation of the data to achieve the best fit. Data points can be shown as dots and form errors can be shown as whiskers.

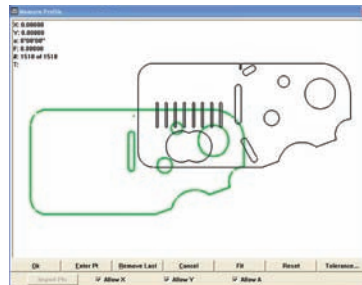

**Probed points shown in Measure Profile Window**

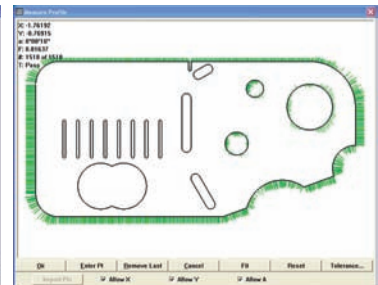

**Fit operation performed and form errors shown as whiskers**

Tolerances can be applied to profile measurements as bilateral or unilateral pass/fail boundaries. Bilateral tolerances can be distributed equally or unequally around the nominal edges of the part, and are specified by the user.

The X, Y and angular offsets, the maximum form error, the number of data points and tolerance pass/fail results can be displayed in the Measure Profile window at the conclusion of the Fit operation. Upon completion of the profile measurement the profile feature is added to the Features template.

## Operator screens and menus

Functions for conducting profile measurements are located across the bottom of the Measure Profile window. Functions for evaluating, displaying and printing results are contained in the Measure Profile menu and in the Measure profile toolbar. These functions are discussed in detail later in this section as part of the profile measurement instructions.

### The Measure Profile window

The Measure Profile window contains functions for:

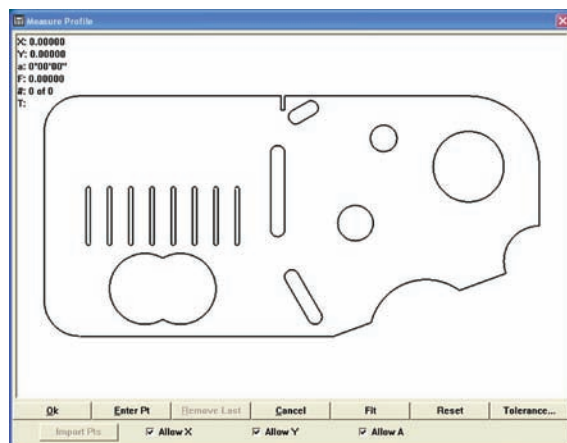

- Allowing (or prohibiting) data shifts during profile fit analyses
- Assigning measurement tolerances
- Entering part data
- Importing part data from the Features template
- Removing the last point data entered
- Initiating a fit operation
- Cancelling a profile measurement
- Resetting the fit results and restoring data points
- Selecting specific data points & whiskers
- Accessing the Measure Profile menu
- Completing the profile measurement

**Measure profile menu and toolbar**

Right-click anywhere in the Measure profile window to display the measure profile menu. The Measure profile menu contains tools for:

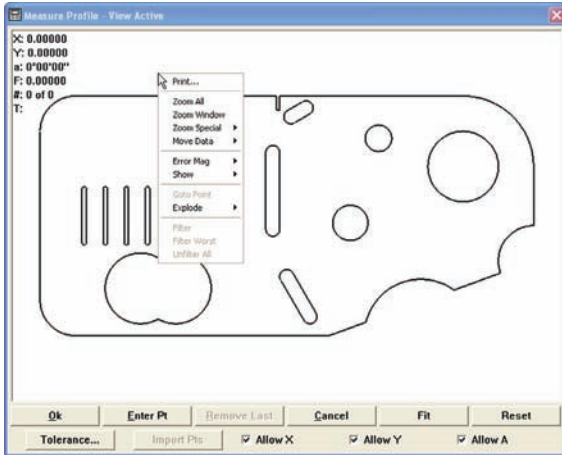

- Printing the contents of the Measure Profile window
- Zooming in and out to display more or less detail
- Moving the data cloud manually to facilitate the fit operation
- Magnifying the display of form error whiskers
- Showing or hiding profile fit information
- Driving the CNC stage to a selected data point location
- Sending (exploding) profile fit data to the Features template as points and distances
- Filtering selected points from the part data
- Filtering the worst point from the part data
- Restoring filtered data (unfiltering) to the part data

The Show/hide profile fit information and form error multiplier functions of the Measure profile menu are duplicated in the Measure profile toolbar shown here.

The Measure toolbar can be displayed by clicking the View/Toolbars menu item, highlighting the Measure toolbar, clicking Show and then clicking OK.

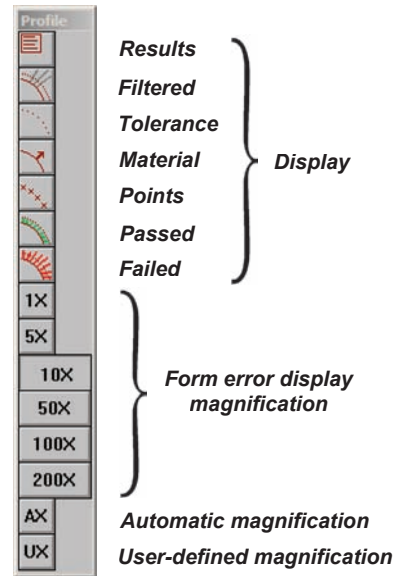
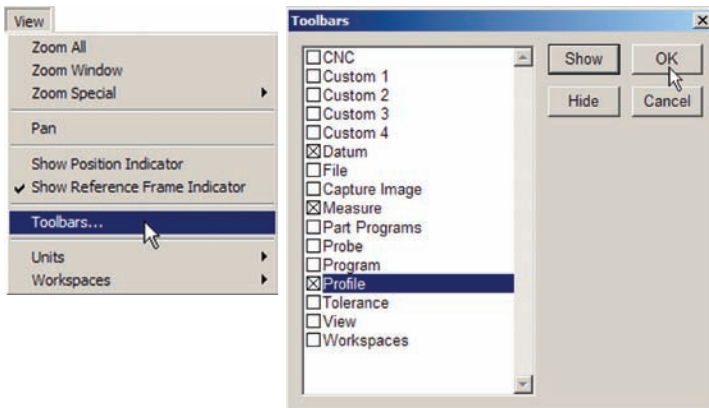



## Conducting profile measurements

This diagram outlines the steps required to perform a typical profile measurement. The details of each step are described in the profile measurement instructions that follow. Details regarding the use of tools found in the profile window, menu and toolbar are discussed after the profile measurement instructions.

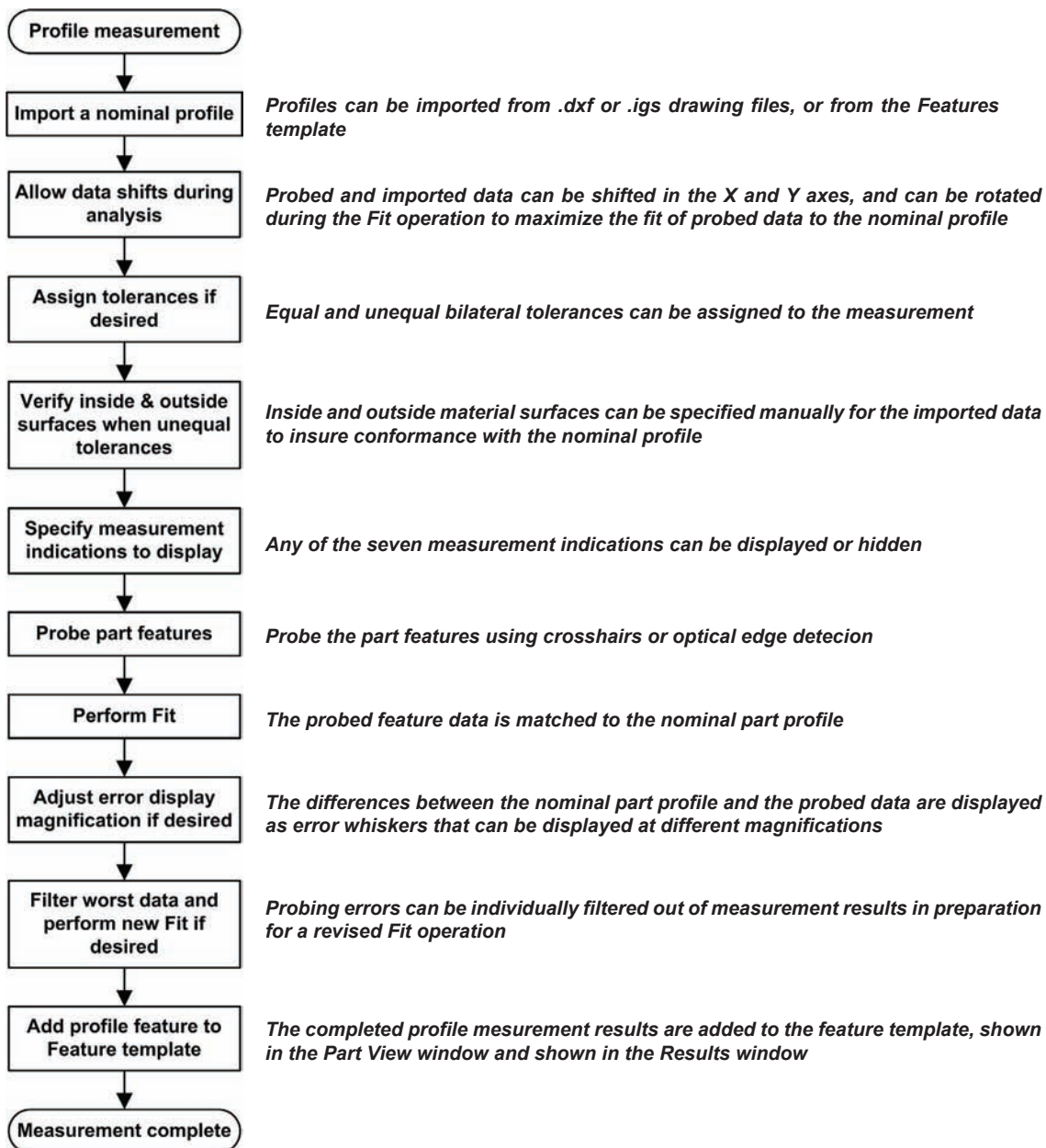

To conduct a profile measurement:

Click the Profile icon in the Measure toolbar, or click the Measure/Profile menu item to initiate a profile measurement. A dialog box will be displayed for importing a nominal part profile.

A nominal part profile can be imported from a drawing file or from the Features template.

### Importing from a drawing file

Nominal part profiles can be imported from .IGS or .DXF drawing files. Click the Import button to import a profile from a drawing file. The Import Profile file dialog box will be displayed.

Select the .IGS or .DXF file type, highlight the desired file name and Click Open to specify the nominal profile data file.

When importing data from .DXF files, the Import Options dialog box will be displayed. Specify the unit of measure originally used to create the file and click OK.

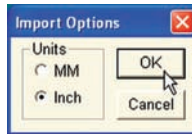

The title bar will show *1 file* indicating that an import file was selected.

Click OK to import the file. The nominal profile will be displayed in the Measure Profile window.

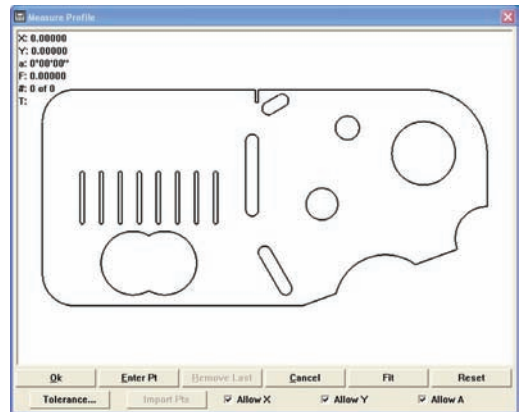
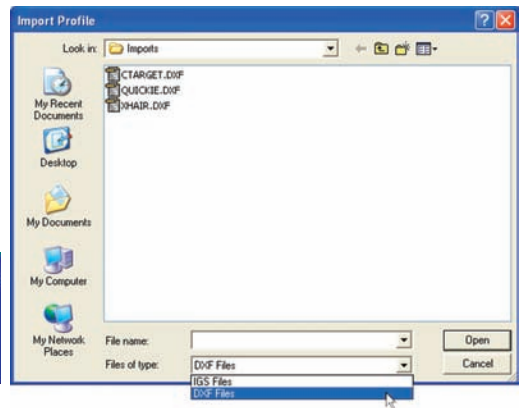
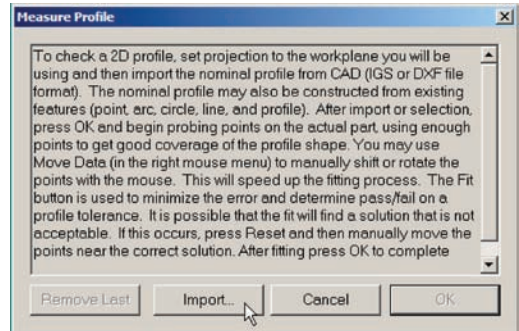
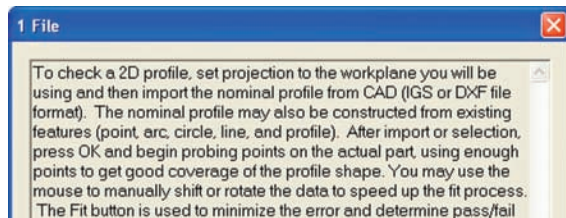

**Importing from the Features template**

Nominal part profile data can be imported from the Features template when the nominal profile is based on previous measurements of standard part. Highlight the desired features in the Features template.

The title bar will show the number of features selected.

Click OK to import the feature data. The nominal profile will be displayed in the Measure Profile window.

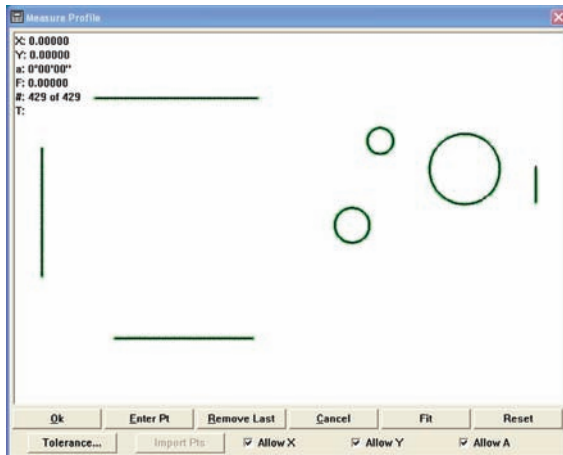
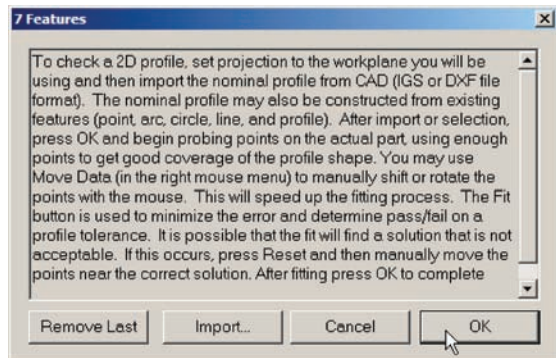
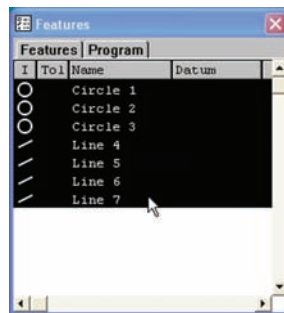

**Allowing (or prohibiting) data shifts during profile fit analyses**

The fit algorithm shifts the probed data points in the Cartesian and polar coordinate systems to achieve the best fit between the data and the nominal part profile.

Maximum degrees of freedom are given to the fit algorithm by checking the Allow X, Allow Y and Allow A boxes across the bottom of the window. Clearing a box prohibits data movement in the indicated orientation.



### Assigning measurement tolerances

Bilateral or unilateral tolerances can be assigned to profile measurements. Bilateral tolerances can be equal or unequal. Click the Tolerance button to display the tolerance zone dialog box.

#### Equal bilateral tolerances

Bilateral tolerance values will be centered around the edges of the nominal profile. For example, an equal bilateral tolerance of 0.005 will be applied as  $\pm 0.0025$ .

Check the Bilateral box and enter the desired tolerance value into the Tolerance data field for equal bilateral tolerances.

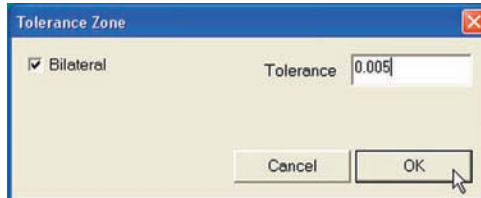

**An equal bilateral tolerance of 0.005 is applied as  $\pm 0.0025$**

#### Unequal tolerances

Unequal bilateral or unilateral tolerance values are specified by the user for In-material and Out-material tolerances. The example below shows a bore with different In-material and Out-material tolerances.

Clear the Bilateral box and enter the desired In-material and Out-material tolerance values in the data fields provided.

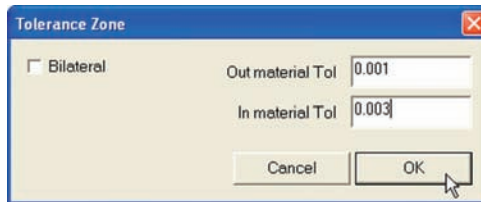

**Unequal bilateral tolerances are applied as +0.003 and -0.001**

Tolerances can be applied to up to 5 different (Form) areas of the part profile. To apply a tolerance to an area, select the area using the mouse cursor in the Measure Profile window, then apply a tolerance as shown above. Tolerance (Form) areas can be displayed and edited by clicking the Tools/Tolerance/Profile menu item.

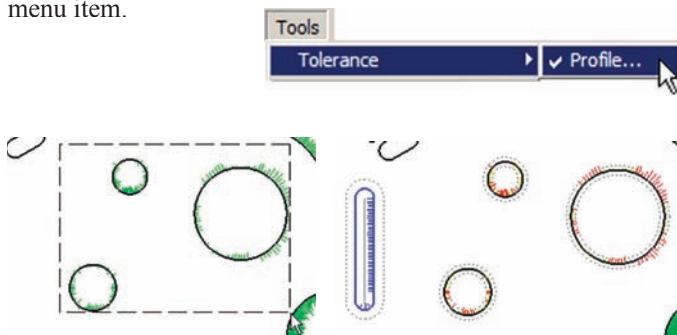

**Selected areas...**

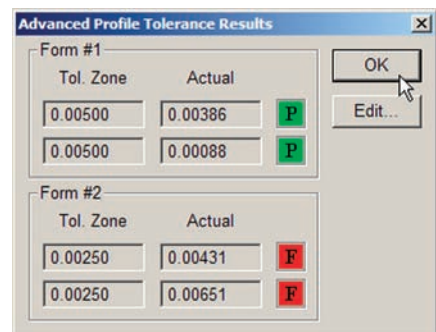

**can be assigned different tolerances that are shown and edited in the Advanced Profile Tolerance Results screen**

**Verifying inside and outside material surfaces**

Right-click the Measure Profile window and then click the Show/Material menu item to display surface normals that are outside the material and normal to the material surfaces. The material indicator lines are used by the system to identify the material sides of nominal part surfaces. This is necessary when unequal inside/outside tolerances are applied to the nominal profile. Material indicator lines must be positioned outside the material surface as shown below.

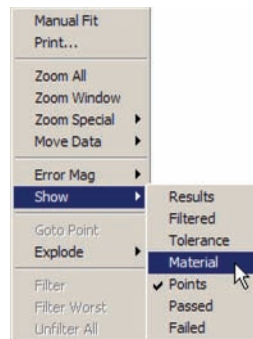

*Material indicator inside a hole*



*Material indicator outside a boss*

The orientation of the material indicator lines can be changed by selecting them with the mouse. Select by clicking on a line, or by dragging a marquee around a line and releasing the mouse button.

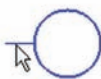

*Clicking on a line...*

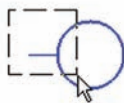

*or selecting a line with a marquee...*



*changes the orientation of the line*

### Specifying measurement indications to display

Right-click the Measure Profile window and then click Show to display a menu of profile fit information that can be toggled on or off in the Measure profile window. Click the desired item to display or hide it in the window. Displayed information can include:

- Results: Numeric profile measurement results
- Filtered: Points filtered out of fit calculation
- Tolerance: Tolerance boundaries as dotted lines
- Material: Surface normals indicating material
- Points: Part profile data points
- Passed: Whiskers indicating form error within tolerance
- Failed: Whiskers indicating form error outside tolerance

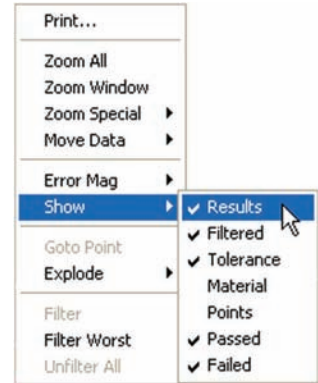

*Checked items are displayed*

The items contained in the Show menu are duplicated in the Profile toolbar. Clicking an icon in the toolbar toggles the display of the corresponding information on or off in the Measure Profile window.

#### Results

Click the Show/Results menu item or toolbar icon to display numeric profile fit results in the upper-left corner of the Measure Profile window.

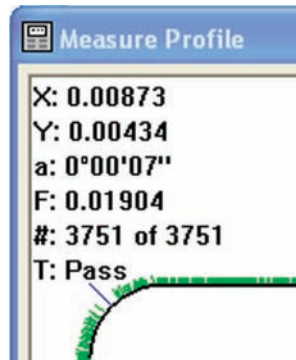

Results  
Filtered  
Tolerance  
Material  
Points  
Passed  
Failed

Display

Form error display magnification

Automatic magnification  
User-defined magnification

Profile fit results include:

- X: The x-axis offset after shifting the data cloud to achieve the best fit.
- Y: The y-axis offset after shifting the data cloud to achieve the best fit.
- a: The angular offset after shifting the data cloud to achieve the best fit.
- F: The form error
- #: The number of points acquired, and the number of points used to determine profile fit results.
- T: The tolerance Pass/Fail result.

### Filtered

Click the Show/Filtered menu item or toolbar icon to display points and error whiskers that were filtered earlier using the Filter or Filter Worst profile menu command. Filtered points appear as dark gray.

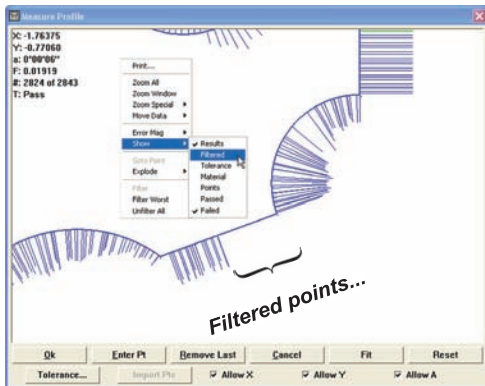

Click Show/Filtered...

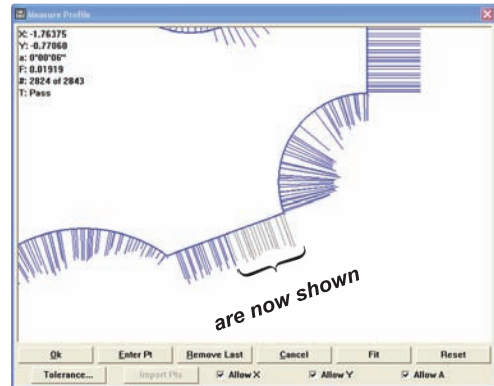

To display previously hidden data

### Tolerance

Click the Show/Tolerance menu item or toolbar icon to display dotted lines that indicate the tolerance zones around profile edges specified earlier using the Tolerance button in the Measure profile window.

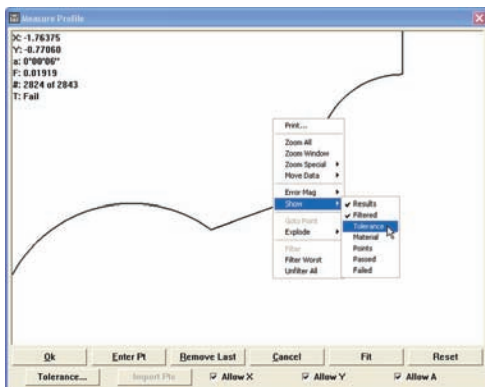

Click Show/Tolerance...

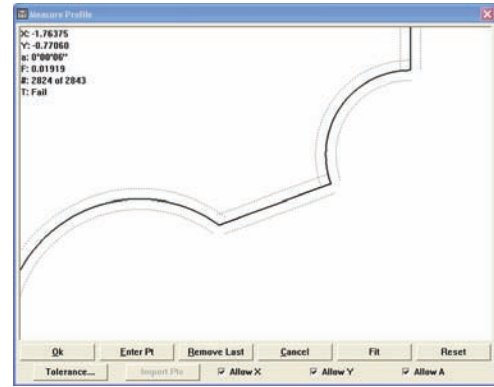

to display tolerance zones

### Material

Click the Show/Material menu item to display surface normals that are outside the material and normal to the material surfaces.

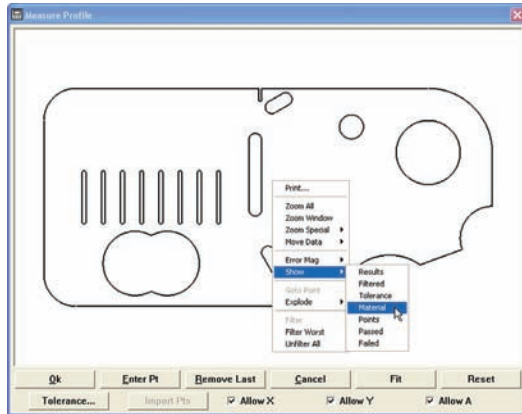

*Click Show/Material...*

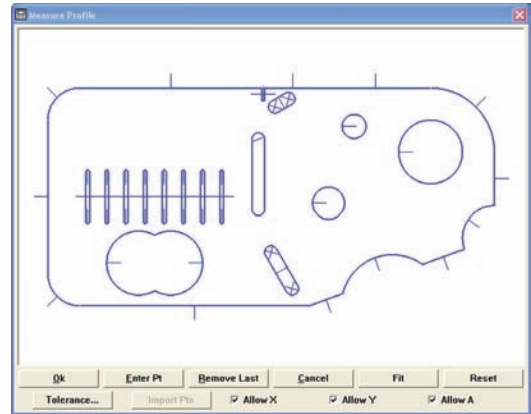

*to display material indicator lines*

### Points

Click the Show/Points menu item or toolbar icon to display the points acquired from measurements in the Part View window.

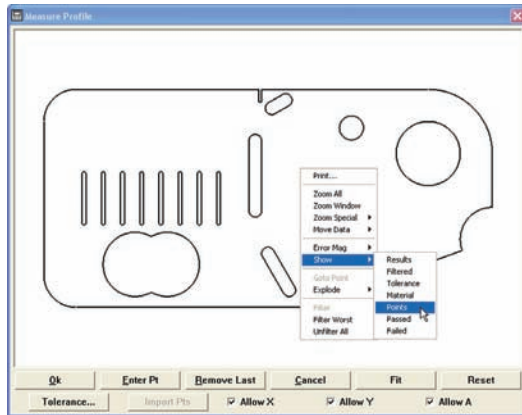

*Click Show/Points...*

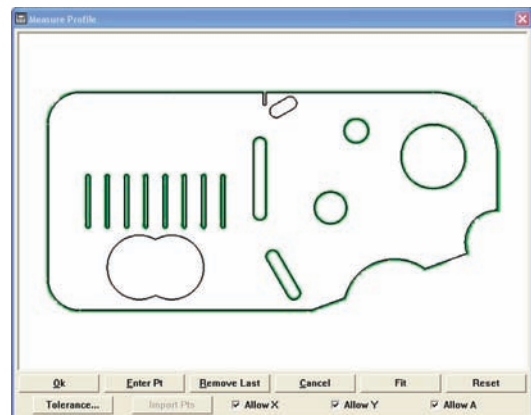

*to display probed data points*

Points will appear as a green dots near measured surfaces until the display magnification is increased to show individual data points.

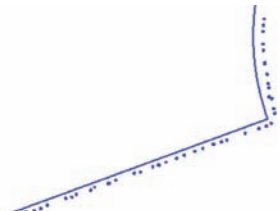



*Passed*

Click the Show/Passed menu item or toolbar icon to display the points and form error whiskers that passed the tolerance criteria. The default colors of points and form error whiskers that passed are green for 0 to 50% and yellow for 51% to 100% of the tolerance value.

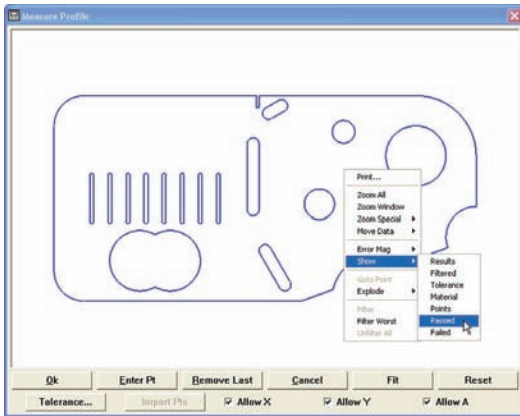

Click Show/Passed...

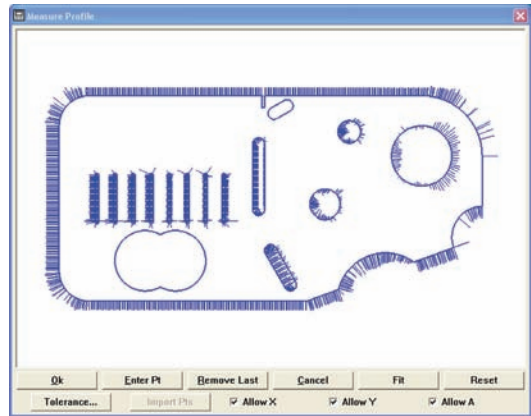

to display points or whiskers that passed tolerance tests

The default colors can be changed in the Tools/Customize/Colors setup screen.

*Failed*

Click the Show/Failed menu item or toolbar icon to display the points and form error whiskers that failed the tolerance criteria. The default color of points and form error whiskers that fail is red for greater than 100% of the tolerance value.

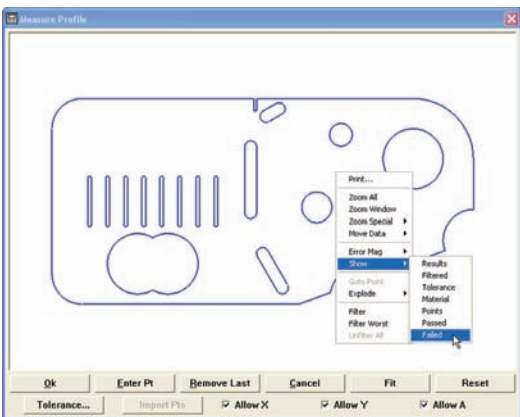

Click Show/Failed...

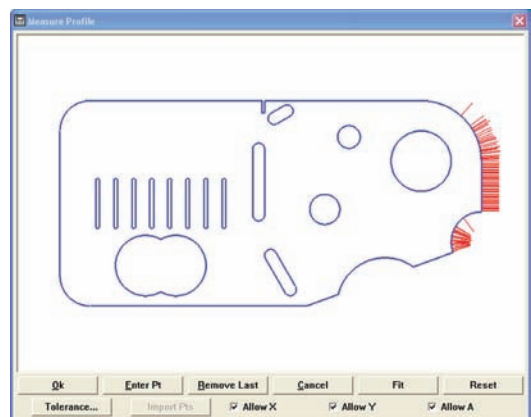

to display points or whiskers that failed tolerance tests

The default color can be changed in the Tools/Customize/Colors setup screen.

### Probing part features

Probe the part features as discussed earlier in this chapter. As points are acquired they appear (in green) in the Measure Profile window.

Probed points are typically entered from the Measure window, however, they can also be entered from the Measure Profile window by clicking the Enter Pt button.

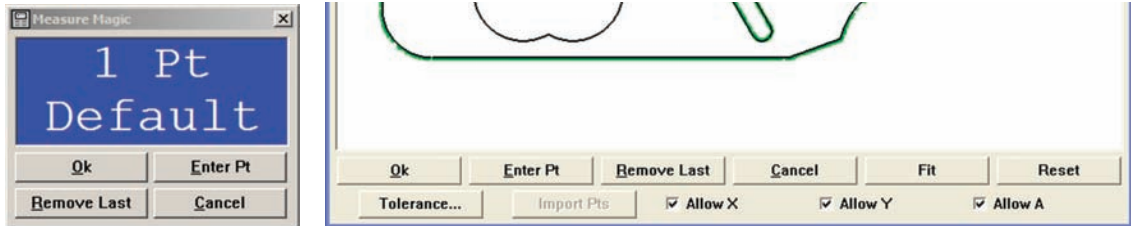

*Click Enter Pt...*

*in the Measure window or at the bottom of the Measure Profile window*

The last data points entered into the Measure Profile window can be removed by clicking the Remove Last button. Multiple data points can be removed by repeatedly clicking the Remove Last button, until no points remain.

### Performing a fit operation

When all the required points for a profile measurement have been probed, press the Fit button at the bottom of the Measure Profile window to perform the fit operation. Additional points probed after a fit operation will be shown as whiskers as a convenience for the user. However, these are only temporary and approximate indications of the error values and will be replaced by precise error whiskers after the next fit operation.

The results of the fit operation can be reset to review the positions of data points, remove data points or change the degrees of freedom for the fit analysis (allow X, Y or A). Click the Reset button at the bottom of the Measure Profile window to reset the last fit results and restore the data points to their original positions prior to the Fit operation.

Click the Cancel button at the bottom of the Measure Profile window to cancel the profile measurement and close the Measure Profile window.

### Magnifying the display of form error whiskers

During the fit operation, probed points that do not fall precisely on the nominal profile generate form errors. When tolerances are specified, the errors are divided into two groups, those that pass (Passed) and those that fail (Failed) tolerance criteria.

The passed and failed errors can be displayed as whiskers that extend orthogonally from the nominal surface. The length of each whisker is proportional to its magnitude of error.

Typically, the magnitude of most form errors is so small in proportion to the part displayed that without magnification they would not be visible. The Error Mag menu item provides fixed, automatic and user-definable levels of magnification for displaying error whiskers.

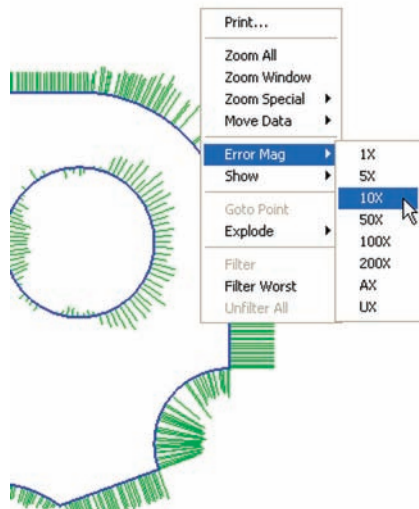

Error magnification levels are also available in the profile toolbar.

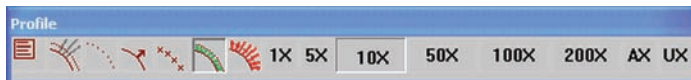

**NOTE**

The Show/Passed or Show/Failed menu item must be checked or toolbar icon must be clicked for whiskers to be displayed.

#### Fixed magnification

Click the Error Mag menu item, then click the desired level of magnification, or click the desired level icon in the toolbar.

#### Automatic magnification

Click the Error Mag menu item, then click AX for automatic adjustment of magnification, or click the AX icon in the toolbar.

When automatic magnification is selected, the system optimizes the display of error whiskers based on the maximum form error value.

#### User-defined magnification

Click the Error Mag menu item, then click UX to specify a level of magnification, or click the UX icon in the toolbar. A data field will be displayed for specifying the level of magnification.

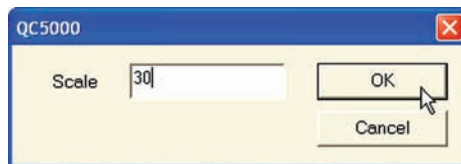
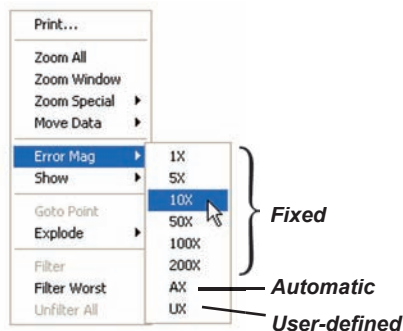

### Filtering the worst (form error) data

Data points can be selectively filtered out of fit operations to evaluate the influence of specific points on fit results, or to eliminate the effects of unwanted measurement artifacts.

Select the point(s) to be filtered, then right-click anywhere in the Measure Profile window to display the Measure Profile menu.

Click on Filter to filter out the selected points, then click Fit to perform a new fit operation. The new results will not include the filtered points.

Click Filter Worst to exclude the data point with the greatest form error from the next fit analysis. Click Filter Worst repeatedly to filter the group of data points with the greatest form errors.

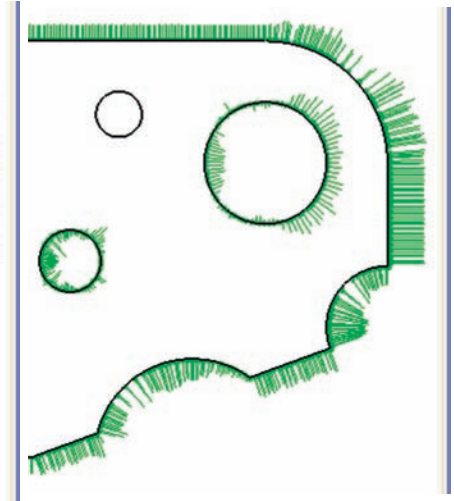
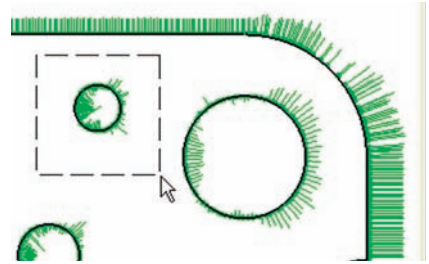
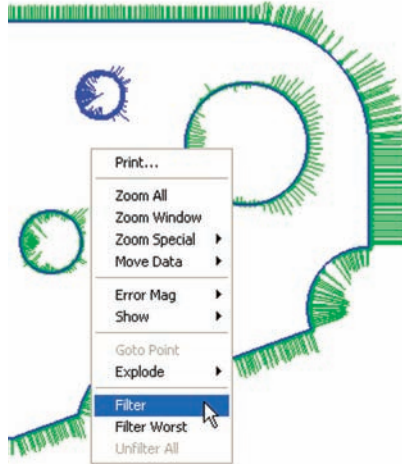

Click Fit to perform a new fit operation. The new results will not include the filtered points.

### Unfiltering (restoring) filtered data points

Right-click anywhere in the Measure Profile window to display the Measure Profile menu. Click Unfilter All to restore all previously filtered data points to the data cloud for the next fit analysis.

### Adding the profile feature to the Feature template

When the profile measurement is complete, press the OK button at the bottom of the Measure Profile window to create the profile feature in the Features template and close the Measure Profile window.

Measurement results are shown in the Features template, Part View window and Results window. The Results window shows the feature identification number, the number of points used in the profile measurement, the coordinate center of the feature, the angular orientation of the feature and the overall, least material and most material form errors.

The profile feature is shown in the Feature Stamp window with form error whiskers that passed tolerance tests in the range of 0 to 50% shown in green, 51 to 100% in yellow. Form errors that fail the tolerance tests are shown in red.

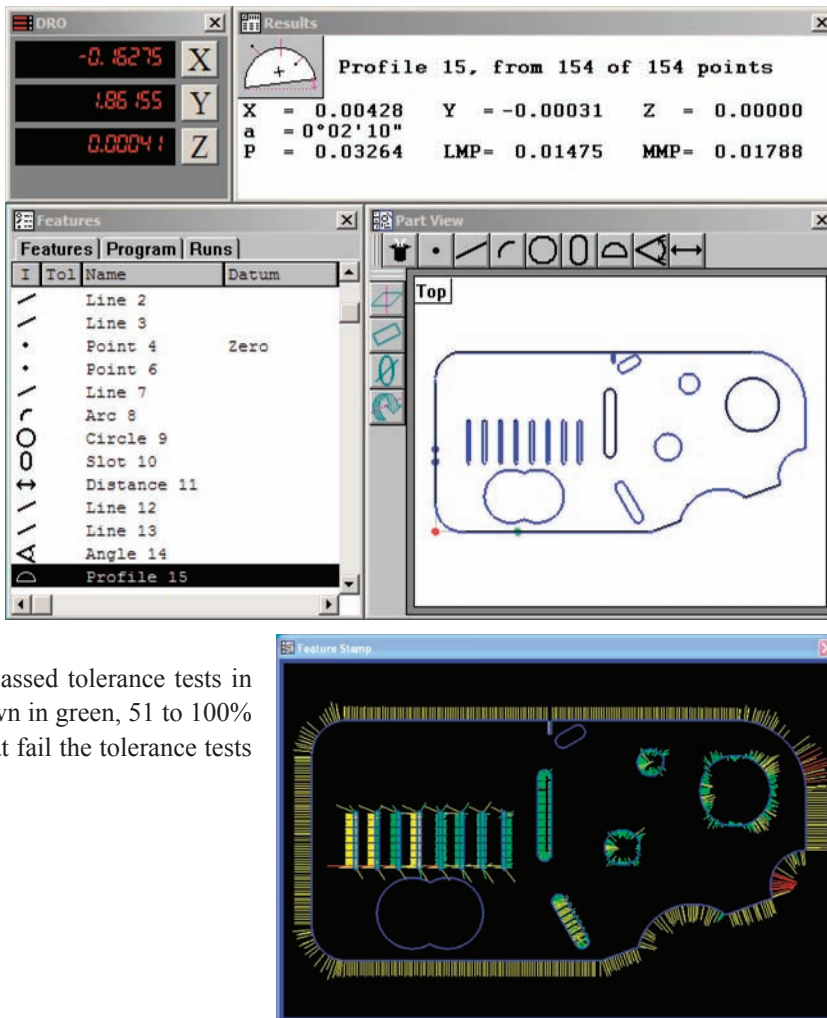

## Constructing features

Features can be constructed from one or more existing features. Existing features used to construct new features are called parent features, and can be features that were measured, constructed or created. The two methods that can be used to construct a feature are shown below. The second method is shown in an example of constructing an angle from two parent lines.

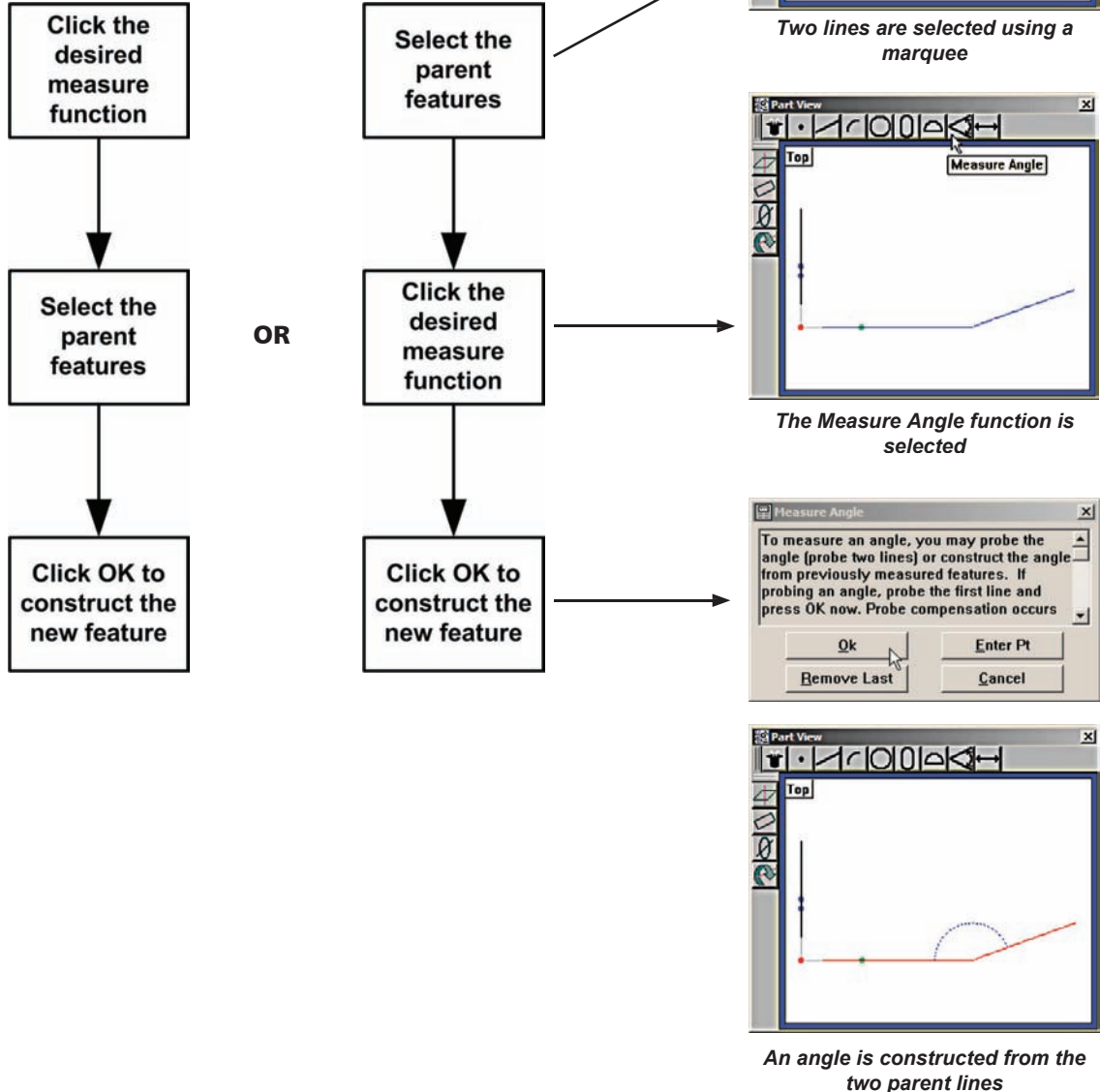

## Point constructions

Points can be constructed from:

- Points
- Lines
- Profiles
- Circles
- Slots
- Distances
- Angles
- Arcs
- Blobs

### Point constructed from a point

A duplicate feature can be useful when it becomes desirable to perform new operations with the point while retaining the original feature. Select the desired point feature, click Measure Point and then click OK. The new point feature will be constructed and will be shown in the Features template, Part View window and Results window.

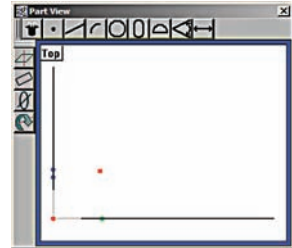

### Point constructed from a point and a line

A perpendicular point can be constructed from a point and a line. Select the desired point and line features, click Measure Point and then click OK. The new point feature will be constructed and will be shown in the Features template, Part View window and Results window.

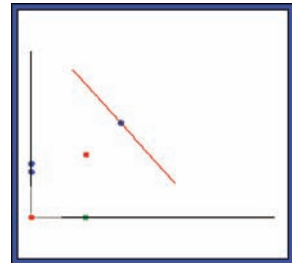

### Points constructed from an arc and a line

Select the arc and the line, click Measure Point and then click OK. The first intersect point of the arc and line will be constructed and will be shown in the Features template, Part View window and Results window. Right-click the Results window to show alternative point constructions.

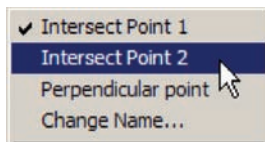
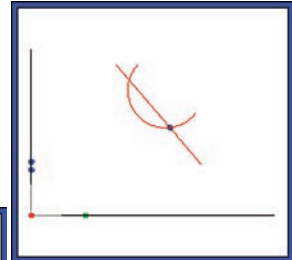

**Right-click the Results window to display menu of alternative features**

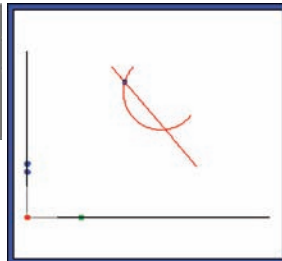

Intersect point 2

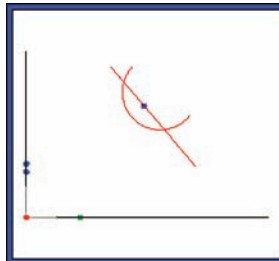

Perpendicular point

### Points constructed from a line

Select the line, click Measure Point and then click OK. The midpoint of the line will be constructed and will be shown in the Features template, Part View window and Results window. Right-click the Results window to show alternative point constructions.

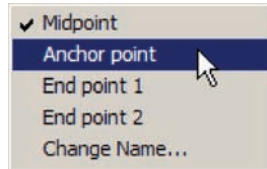

*Right-click the Results window to display menu of alternative features*

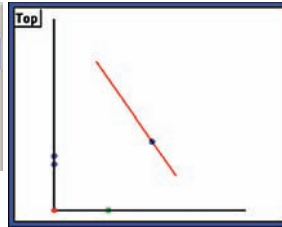

*Anchor point*

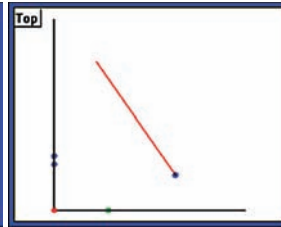

*End point 1*

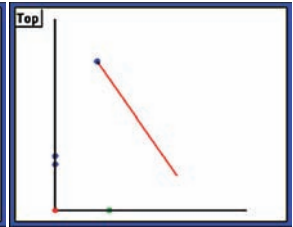

*End point 2*

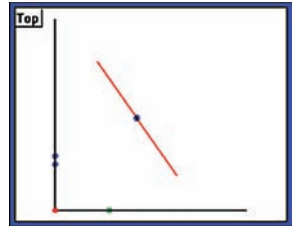

### Point constructed from two lines

Select the lines, click Measure Point and then click OK. The intersection point of the lines will be constructed and will be shown in the Features template, Part View window and Results window. The virtual intersection point will be calculated and shown if the lines do not actually cross.

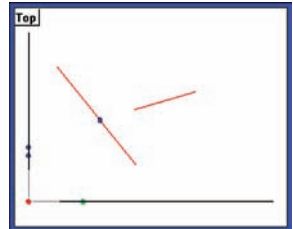
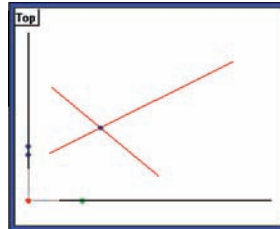

*Virtual intersection*



**Points constructed from a distance**

Select the distance, click Measure Point and then click OK. The first endpoint of the distance will be constructed and will be shown in the Features template, Part View window and Results window. Right-click the Results window to show alternative point constructions.

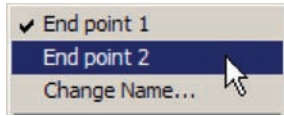

*Right-click the Results window to display menu of alternative features*

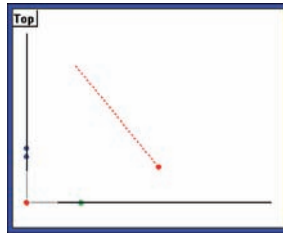

*End point 2*

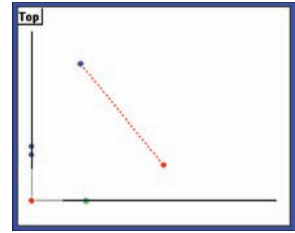

**Point constructed from a distance and a point**

A point feature can be constructed and offset from a parent point feature by a parent distance feature. Select the desired point and distance features, click Measure Point and then click OK. The new point feature will be constructed, offset from the parent point and will be shown in the Features template, Part View window and Results window.

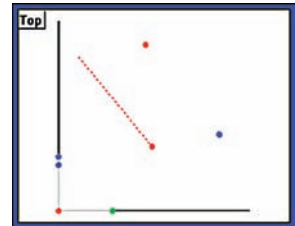

*Constructed point is offset from parent point by parent distance*

**Point constructed from a circle**

Select the circle, click Measure Point and then click OK. The center point of the circle will be constructed and will be shown in the Features template, Part View window and Results window.

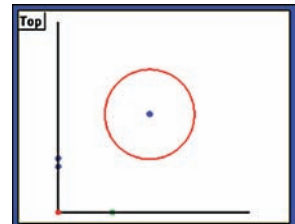

### Points constructed from a circle and a line

Select the circle and the line, click Measure Point and then click OK. The first intersect point of the circle and line will be constructed and will be shown in the Features template, Part View window and Results window. Right-click the Results window to show alternative point constructions.

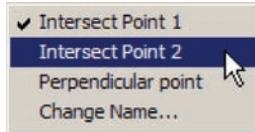

*Right-click the Results window to display menu of alternative features*

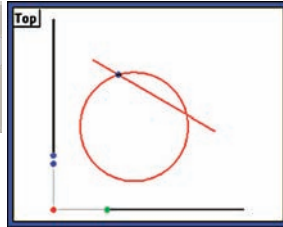

*Intersect point 2*

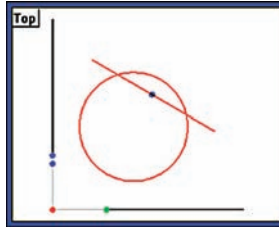

*Perpendicular point*

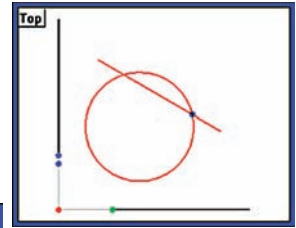

### Points constructed from two circles

Select the circles, click Measure Point and then click OK. The first intersect point of the two circles will be constructed and will be shown in the Features template, Part View window and Results window. Right-click the Results window to show alternative point constructions.

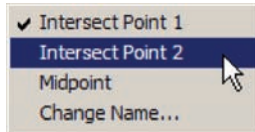

*Right-click the Results window to display menu of alternative features*

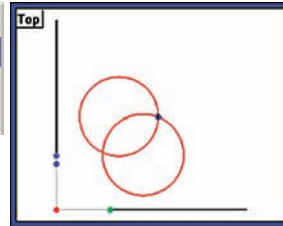

*Intersect point 2*

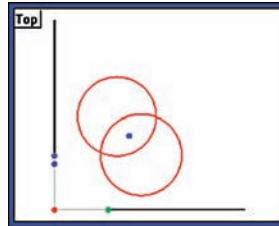

*Midpoint*

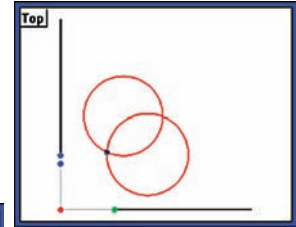

### Point constructed from a slot

Select the slot, click Measure Point and then click OK. The center point of the slot will be constructed and will be shown in the Features template, Part View window and Results window.

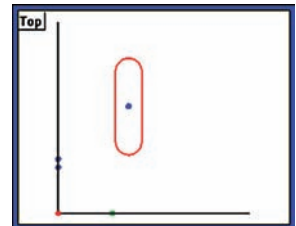

**Point constructed from an angle**

Select the angle, click Measure Point and then click OK. The apex point of the angle will be constructed and will be shown in the Features template, Part View window and Results window.

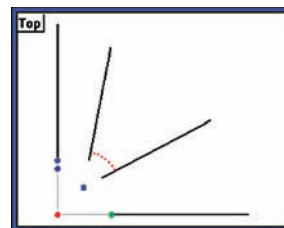
**Point constructed from an arc**

Select the arc, click Measure Point and then click OK. The center point of the arc radius will be constructed and will be shown in the Features template, Part View window and Results window.

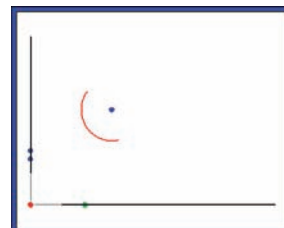
**Point constructed from a profile**

Select the profile, click Measure Point and then click OK. The anchor point of the profile will be constructed and will be shown in the Features template, Part View window and Results window.

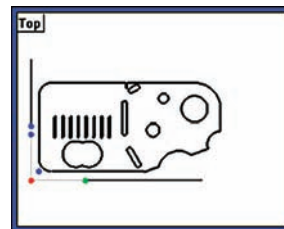
**Point constructed from a blob**

Select the blob, click Measure Point and then click OK. The geometric center point of the blob will be constructed and will be shown in the Features template, Part View window and Results window.

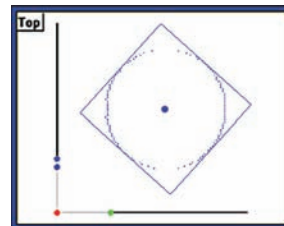
**Points constructed from multiple features**

The geometric center point of multiple features can be constructed from any combination and any number of points, slots, circles, arcs and blobs. Select the desired features, click Measure Point and then click OK. The center point (centroid) of the entire collection of features will be constructed and will be shown in the Features template, Part View window and Results window.

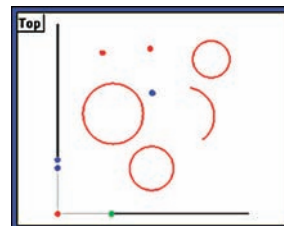

## Line constructions

Lines can be constructed from:

- Points
- Lines
- Profiles
- Circles
- Slots
- Distances
- Angles
- Arcs
- Blobs

### ***Line constructed from a line***

A duplicate feature can be useful when it becomes desirable to perform new operations with the line while retaining the original feature. Select the desired line feature, click Measure Line and then click OK. The new line feature will be constructed and will be shown in the Features template, Part View window and Results window.

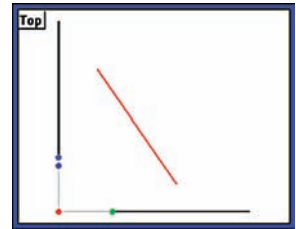

### ***Line constructed from two points***

Select the desired point features, click Measure Line and then click OK. The new line feature will be constructed between the two points and will be shown in the Features template, Part View window and Results window.

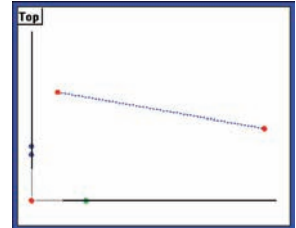

### ***Lines constructed from a point and a line***

A line feature can be constructed from parent point perpendicular to a line feature. Select the desired point and line features, click Measure Line and then click OK. The new line feature will be shown in the Features template, Part View window and Results window. Right-click the Results window to show an alternative line feature.

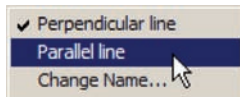

***Right-click the Results window to display an alternative feature***

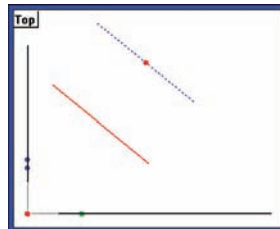

***Parallel line***

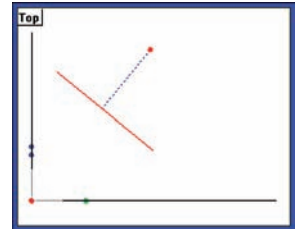

### Lines constructed from a point and a circle

Select the desired point and circle features, click Measure Line and then click OK. The new line feature will be constructed from the point to the center of the circle, and will be shown in the Features template, Part View window and Results window. Right-click the Results window to show alternative line features.

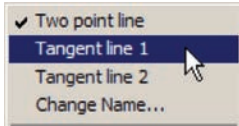

Right-click the Results window to display an alternative feature

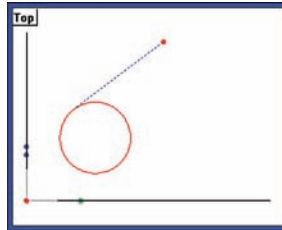

Tangent line 1

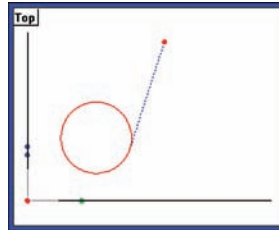

Tangent line 2

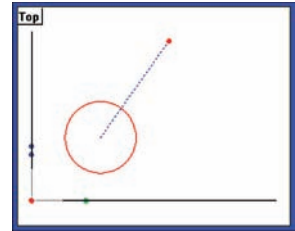

### Line constructed from a point and a slot

Select the desired point and slot features, click Measure Line and then click OK. The new line feature will be constructed from the point to the center of the slot, and will be shown in the Features template, Part View window and Results window.

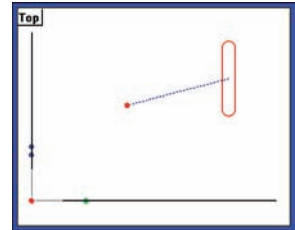

### Lines constructed from a point and an arc

Select the desired point and arc features, click Measure Line and then click OK. The new line feature will be constructed from the point to the center of the arc radius, and will be shown in the Features template, Part View window and Results window. Right-click the Results window to show alternative line features.

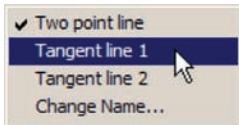

Right-click the Results window to display an alternative feature

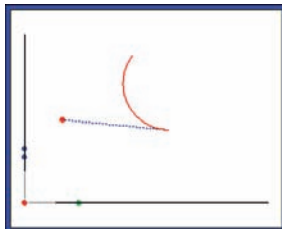

Tangent line 1

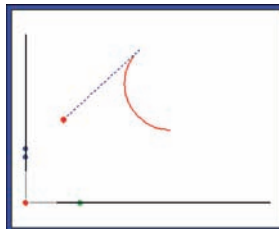

Tangent line 2

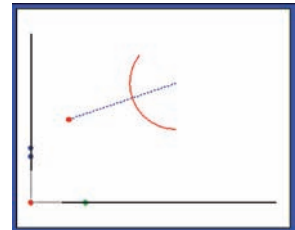

### Lines constructed from two lines

Select the desired line features, click Measure Line and then click OK. The new line feature will be constructed bisecting the angle between the two parent lines, and will be shown in the Features template, Part View window and Results window. Right-click the Results window to show alternative line features. When the Gage line alternative is selected, you will be prompted for the gage line length.

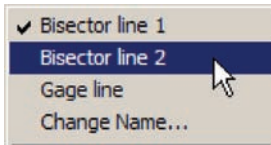
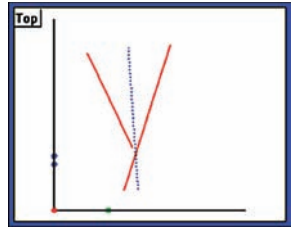

Right-click the Results window to display an alternative feature

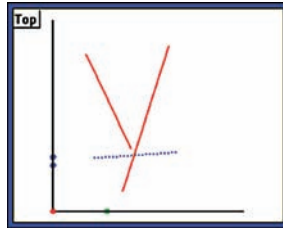

*Bisector line 2*

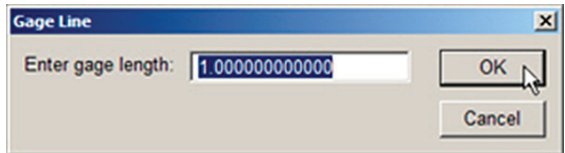

User prompt for gage line length

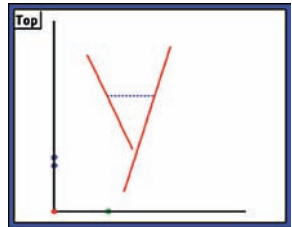

*Gage line length*

### Line constructed from a line and a distance

An offset line can be constructed from line and distance parent features. Select the desired line and distance features, click Measure Line and then click OK. The line will be constructed, offset the amount equal to the distance parent and will be shown in the Features template, Part View window and Results window.

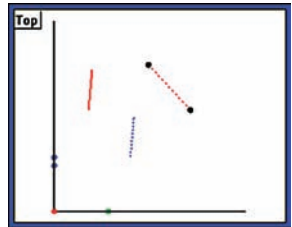

### Lines constructed from a line and a circle

Select the desired line and circle features, click Measure Line and then click OK. The new line feature will be constructed from the center of the circle perpendicular to the parent line, and will be shown in the Features template, Part View window and Results window. Right-click the Results window to show alternative line features.

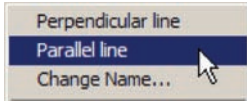

**Right-click the Results window to display alternative features**

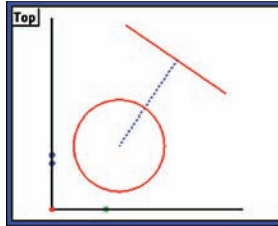

*Perpendicular line*

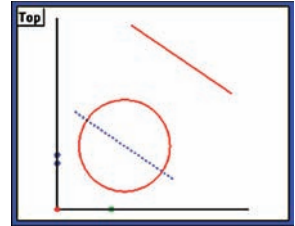

*Parallel line*

### Lines constructed from a line and a slot

Select the desired line and slot features, click Measure Line and then click OK. The new line feature will be constructed from the center of the slot perpendicular to the center of the line, and will be shown in the Features template, Part View window and Results window.

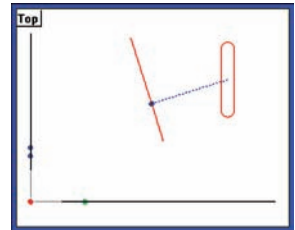

### Lines constructed from a line and an arc

Select the desired line and arc features, click Measure Line and then click OK. The new line feature will be constructed from the center of the arc perpendicular to the parent line, and will be shown in the Features template, Part View window and Results window. Right-click the Results window to show alternative line features.

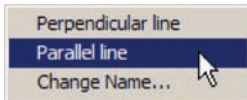

**Right-click the Results window to display alternative features**

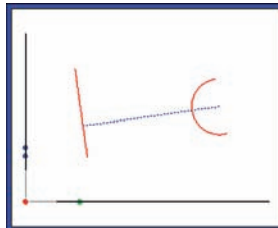

*Perpendicular line*

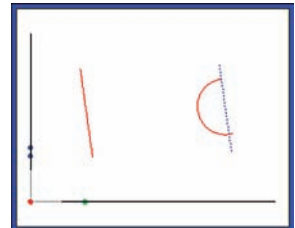

*Parallel line*

### Line constructed from a line and an angle

A rotated line can be constructed from line and angle parent features. Select the desired line and angle features, click Measure Line and then click OK. The line will be constructed, rotated counterclockwise the amount equal to the angle parent and will be shown in the Features template, Part View window and Results window.

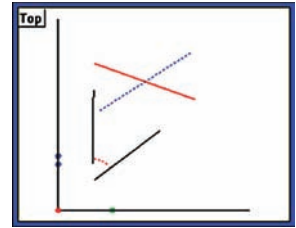

### Lines constructed from two circles

Select the desired circle features, click Measure Line and then click OK. The new line feature will be constructed between the center points of the parent circles, and will be shown in the Features template, Part View window and Results window. Right-click the Results window to show alternative line features.

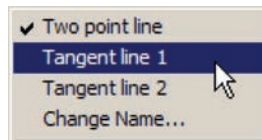
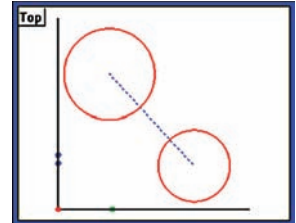

Right-click the Results window to display alternative features

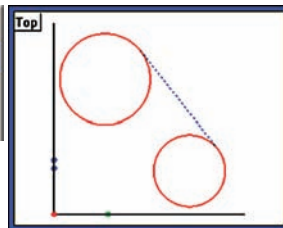

Tangent line 1

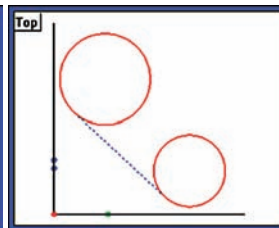

Tangent line 2

### Lines constructed from a circle and an arc

Select the desired circle and arc features, click Measure Line and then click OK. The new line feature will be constructed from the center of the circle to the center of the arc, and will be shown in the Features template, Part View window and Results window. Right-click the Results window to show alternative line features.

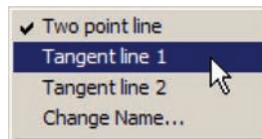
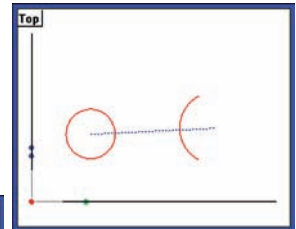

Right-click the Results window to display alternative features

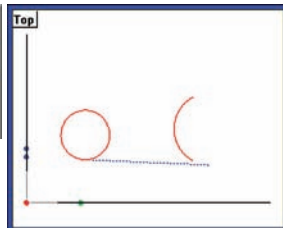

Tangent line 1

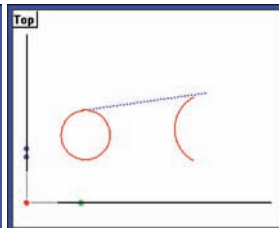

Tangent line 2



**Lines constructed from a circle and a slot**

Select the desired circle and slot features, click Measure Line and then click OK. The new line feature will be constructed from the center of the circle to the center of the slot, and will be shown in the Features template, Part View window and Results window.

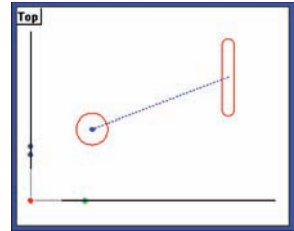

**Line constructed from a slot**

A midline can be constructed from a slot parent feature. Select the desired slot feature, click Measure Line and then click OK. The midline will be constructed and will be shown in the Features template, Part View window and Results window.

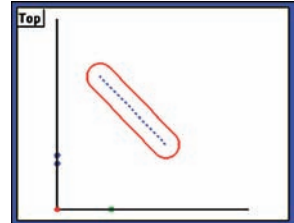

**Line constructed from two slots**

Select the desired slot features, click Measure Line and then click OK. The new line feature will be constructed between the slot centers, and will be shown in the Features template, Part View window and Results window.

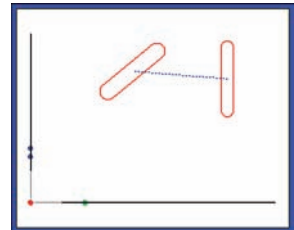

**Line constructed from two arcs**

Select the desired arc features, click Measure Line and then click OK. The new line feature will be constructed between the center points of the parent arcs, and will be shown in the Features template, Part View window and Results window. Right-click the Results window to show alternative line features.

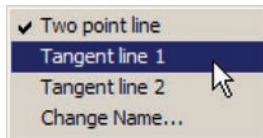
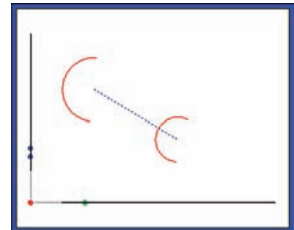

**Right-click the Results window to display alternative features**

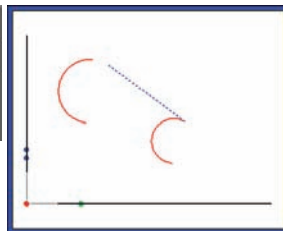

**Tangent line 1**

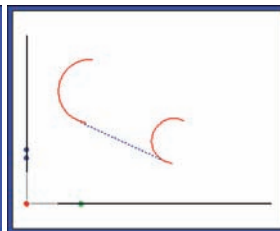

**Tangent line 2**

### ***Line constructed from two blobs***

Select the desired blob features, click Measure Line and then click OK. The new line feature will be constructed between the blob geometric centers, and will be shown in the Features template, Part View window and Results window.

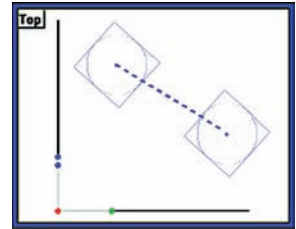

### ***Lines constructed from multiple features***

A best fit line through the center of multiple features can be constructed from any combination and any number of points, slots, circles, arcs and blobs. Select the desired features, click Measure Line and then click OK. The line will be constructed and will be shown in the Features template, Part View window and Results window. Right-click the Results window to select a different fitting algorithm for the data.

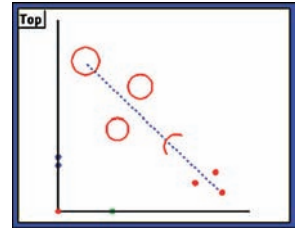

## Distance constructions

Distances can be constructed from:

- Points
- Lines
- Circles
- Slots
- Distances
- Arcs
- Blobs

### ***Distance constructed from a distance***

A duplicate feature can be useful when it becomes desirable to perform new operations with the distance while retaining the original feature. Select the desired distance feature, click Measure Distance and then click OK. The new distance feature will be constructed and will be shown in the Features template, Part View window and Results window. Right-click the Results window to select an alternative feature type.

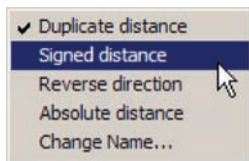

The new distance feature will be constructed and will be shown in the Features template, Part View window and Results window. Right-click the Results window to select an alternative feature type.

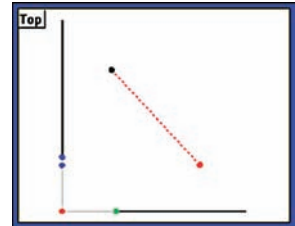

***Right-click the Results window to display alternative features***

### ***Distances constructed from two points***

Select the desired points, click Measure Distance and then click OK. The new distance feature will be constructed between the two points and will be shown in the Features template, Part View window and Results window.

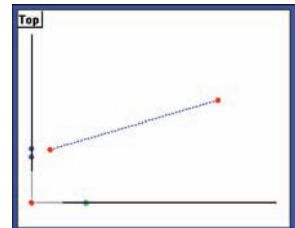

### ***Distances constructed from a point and a line***

The distance path from a point feature to a line feature will be perpendicular to the line, or to the virtual line if the line is short. Select the desired points, click Measure Distance and then click OK. The new distance feature will be constructed and will be shown in the Features template, Part View window and Results window.

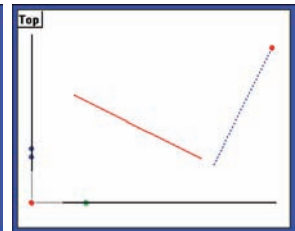
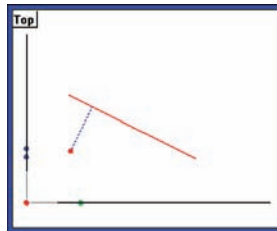

### ***Distances constructed from a point and a circle***

Select the desired point and circle features, click Measure Distance and then click OK. The new distance feature will be constructed to the center of the circle and will be shown in the Features template, Part View window and Results window. Right-click the Results window to select an alternative feature type.

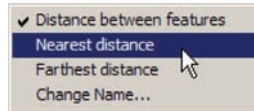

***Right-click the Results window to display alternative features***

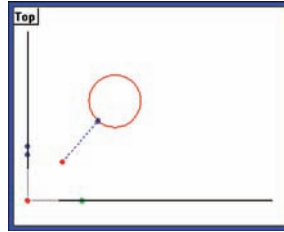

***Nearest distance***

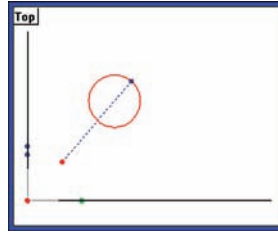

***Farthest distance***

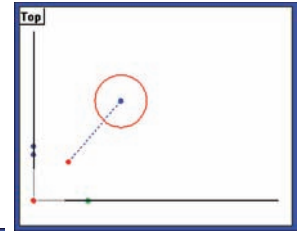

### ***Distance constructed from a point and a slot***

Select the desired point and slot features, click Measure Distance and then click OK. The new distance feature will be constructed to the center of the slot and will be shown in the Features template, Part View window and Results window.

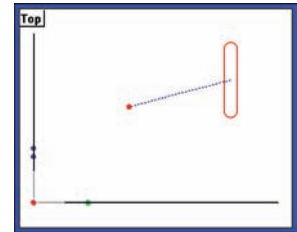

### ***Distances constructed from a point and a arc***

Select the desired point and arc features, click Measure Distance and then click OK. The new distance feature will be constructed to the center of the arc and will be shown in the Features template, Part View window and Results window. Right-click the Results window to select an alternative feature type.

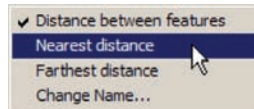

***Right-click the Results window to display alternative features***

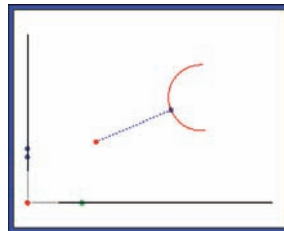

***Nearest distance***

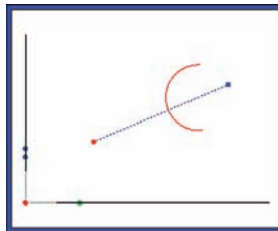

***Farthest distance***

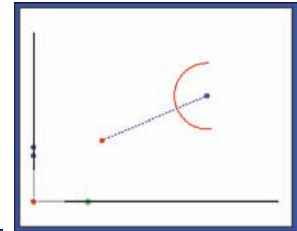

### Distance constructed from a line

A length-of-axis distance feature can be constructed from a parent line feature. Select the desired line feature, click Measure Distance and then click OK. The new distance feature will be constructed and will be shown in the Features template, Part View window and Results window.

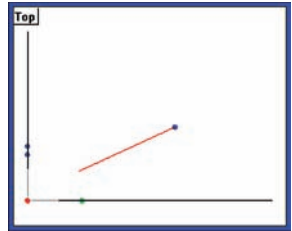

### Distances constructed from two lines

Select the desired lines, click Measure Distance and then click OK. The new distance feature will be constructed perpendicular to the first line and will be shown in the Features template, Part View window and Results window. Right-click the Results window to select an alternative feature type.

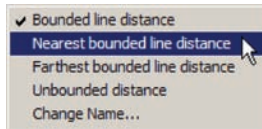
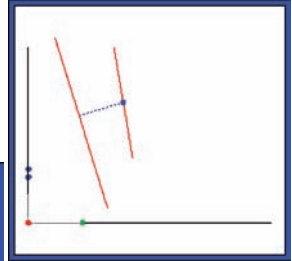

**Right-click the Results window to display alternative features**

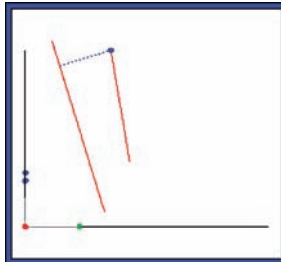
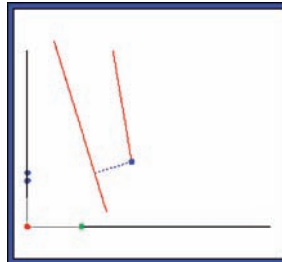

*Nearest bounded distance    Farthest bounded distance*

### Distances constructed from a line and a circle

Select the desired line and circle features, click Measure Distance and then click OK. The new distance feature will be constructed from the center of the circle perpendicular to the line and will be shown in the Features template, Part View window and Results window. Right-click the Results window to select an alternative feature type.

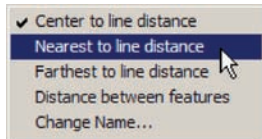
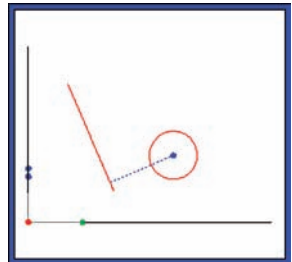

**Right-click the Results window to display alternative features**

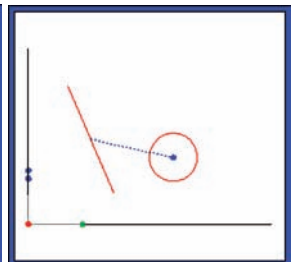
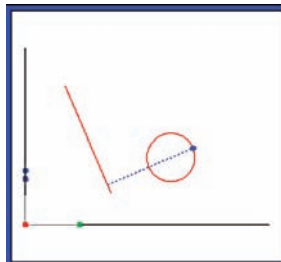
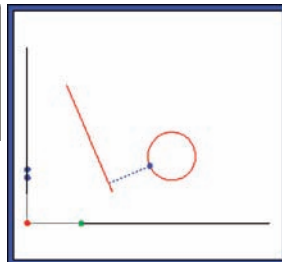

*Nearest distance*

*Farthest distance*

*Distance between features*

### ***Distance constructed from a line and a slot***

Select the desired line and slot features, click Measure Distance and then click OK. The new distance feature will be constructed from the center of the slot perpendicular to the line and will be shown in the Features template, Part View window and Results window.

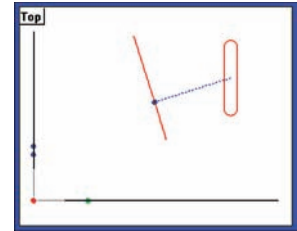

### ***Distances constructed from a line and an arc***

Select the desired line and arc features, click Measure Distance and then click OK. The new distance feature will be constructed from the center of the arc perpendicular to the line and will be shown in the Features template, Part View window and Results window. Right-click the Results window to select an alternative feature type.

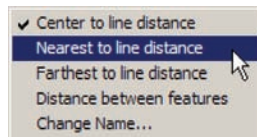
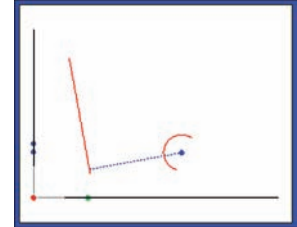

***Right-click the Results window to display alternative features***

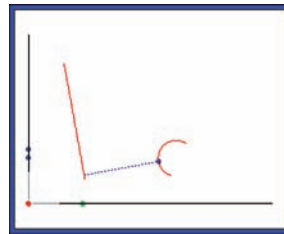

***Nearest to line distance***

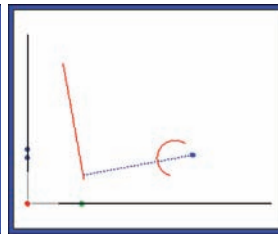

***Farthest to line distance***

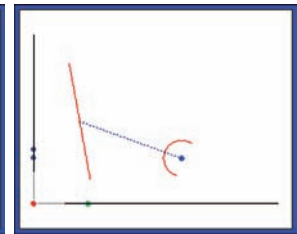

***Distance between features***

### ***Distance constructed from two distances***

A sum-of-distances distance feature can be constructed from two distance features. Select the desired distance features, click Measure Distance and then click OK. The new distance feature will be constructed as the vector sum of the parent distances and will be shown in the Features template, Part View window and Results window.

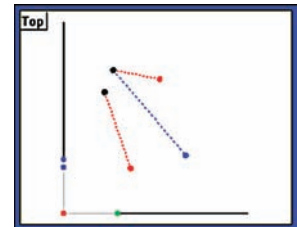

### Distances constructed from two circles

Select the desired circle features, click Measure Distance and then click OK. The new distance feature will be constructed between the centers of the circles and will be shown in the Features template, Part View window and Results window. Right-click the Results window to select an alternative feature type.

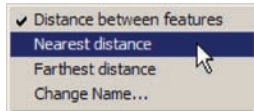

**Right-click the Results window to display alternative features**

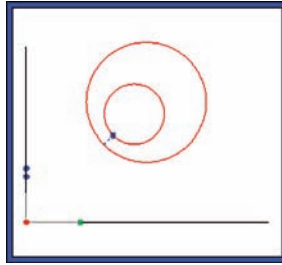

Nearest distance

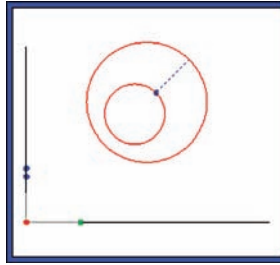

Farthest distance

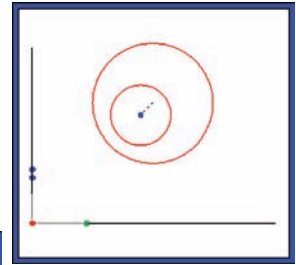

### Distances constructed from a slot and a circle

Select the desired slot and circle features, click Measure Distance and then click OK. The new distance feature will be constructed between the feature centers and will be shown in the Features template, Part View window and Results window.

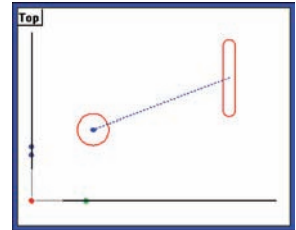

### Distances constructed from an arc and a circle

Select the desired arc and circle features, click Measure Distance and then click OK. The new distance feature will be constructed between the feature centers and will be shown in the Features template, Part View window and Results window. Right-click the Results window to select an alternative feature type.

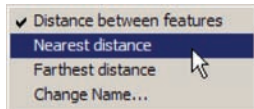
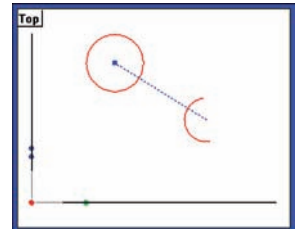

**Right-click the Results window to display alternative features**

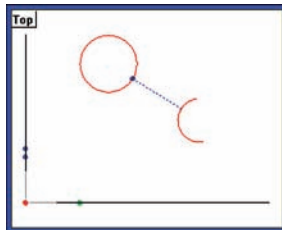

Nearest distance

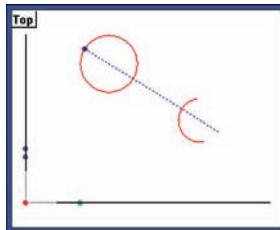

Farthest distance

### ***Distance constructed from two slots***

Select the desired slot features, click Measure Distance and then click OK. The new distance feature will be constructed between the feature centers and will be shown in the Features template, Part View window and Results window.

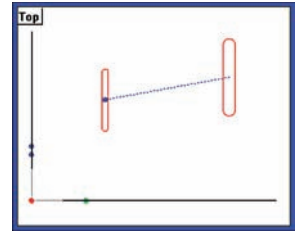

### ***Distances constructed from a slot and an arc***

Select the desired slot and arc features, click Measure Distance and then click OK. The new distance feature will be constructed between the feature centers and will be shown in the Features template, Part View window and Results window.

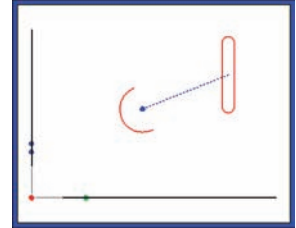

### ***Distances constructed from two arcs***

Select the desired arc features, click Measure Distance and then click OK. The new distance feature will be constructed between the feature centers and will be shown in the Features template, Part View window and Results window. Right-click the Results window to select an alternative feature type.

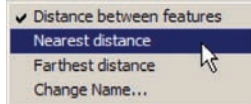
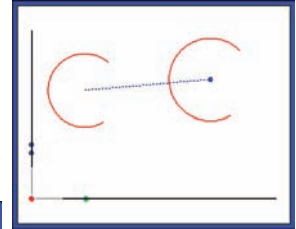

***Right-click the Results window to display alternative features***

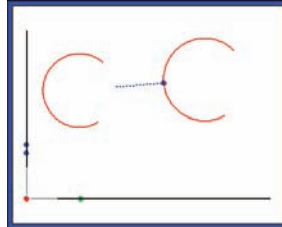

***Nearest distance***

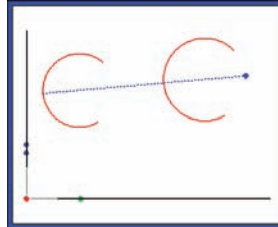

***Farthest distance***

### ***Distances constructed from two blobs***

Select the desired blob features, click Measure Distance and then click OK. The new distance feature will be constructed between the blob geometric centers, and will be shown in the Features template, Part View window and Results window.

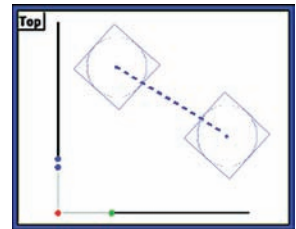



## Circle constructions

Circles can be constructed from:

- Points
- Lines
- Circles
- Slots
- Distances
- Arcs
- Blobs

### Circle constructed from a circle

A duplicate feature can be useful when it becomes desirable to perform new operations with the circle while retaining the original feature. Select the desired circle feature, click Measure Circle and then click OK. The new circle feature will be constructed and will be shown in the Features template, Part View window and Results window.

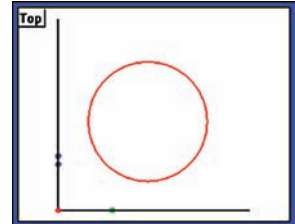

### Circle constructed from three features

An ideal circle feature can be constructed from three parent features. The three parent features can be any combination of points, slots, arcs, circles and blobs. The center points of the three parent features will be used to construct the new circle feature. Select the desired features, click Measure Circle and then click OK. The new circle feature will be constructed and will be shown in the Features template, Part View window and Results window.

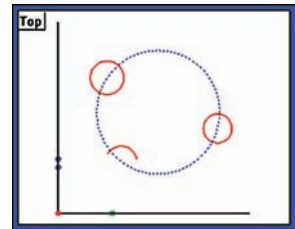

### Circle constructed from more than three features

A circle feature can be constructed from any number of parent features. The parent features can be any combination of points, slots, arcs and circles and blobs. The center points of the parent features will be used to construct the new circle feature. When more than three parent features are used, the circle can be constructed using the fitting algorithm of the user's choice. Select the desired features, click Measure Circle and then click OK. The new circle feature will be constructed and will be shown in the Features template, Part View window and Results window. Right-click the Results window to select a different fitting algorithm for the data.

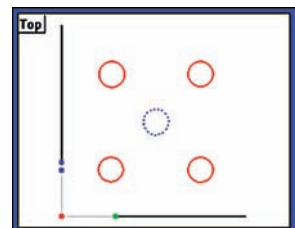
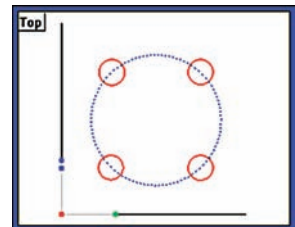

Average circle

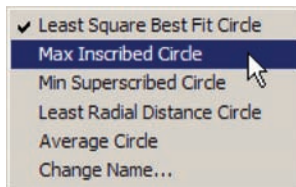

**Right-click the Results window to display alternative features**

### Circles constructed from two lines

Circles will be constructed tangent to the two parent lines. The user will be prompted for the circle radius each time a new circle feature type is selected. Select the desired line features, click Measure Circle and then click OK. The new circle feature will be constructed and will be shown in the Features template, Part View window and Results window. Right-click the Results window to select a different circle feature type.

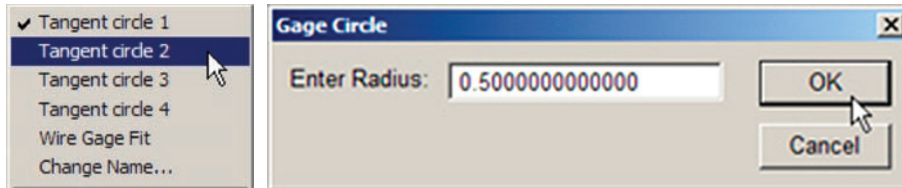
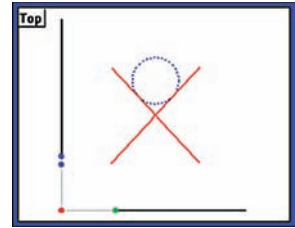

Right-click the Results window to display alternative features

User prompt for radius

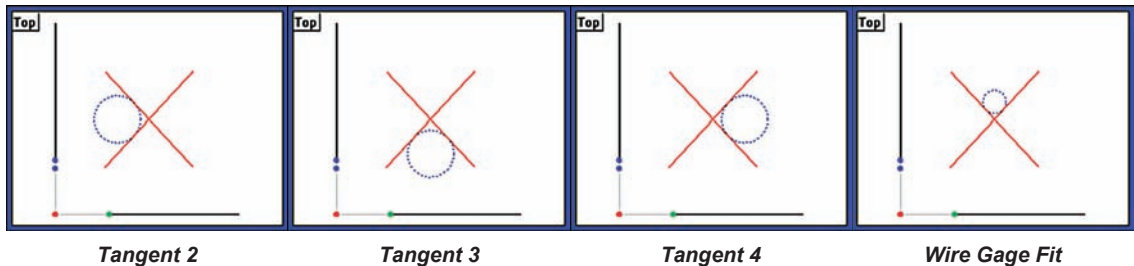

### Circle constructed from a circle and a distance

An offset circle can be constructed from circle and distance parent features. Select the desired circle and distance features, click Measure Circle and then click OK. A circle equal to the parent circle will be constructed, offset the amount equal to the distance parent and will be shown in the Features template, Part View window and Results window.

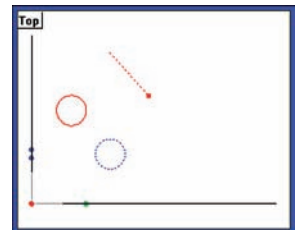

### Circles constructed from two circles

Circles will be constructed tangent to the two parent circles, or as an average of the two parent positions and sizes. The user will be prompted for the circle radius each time a new circle feature type is selected. Select the desired circle features, click Measure Circle and then click OK. The new circle feature will be constructed and will be shown in the Features template, Part View window and Results window. Right-click the Results window to select a different circle feature type.

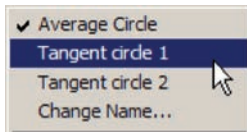
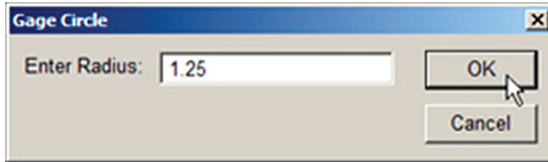
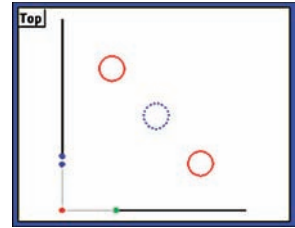

User prompt for radius

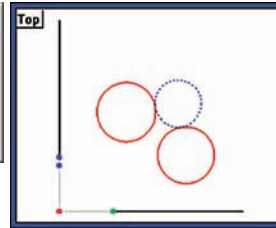

Tangent 1

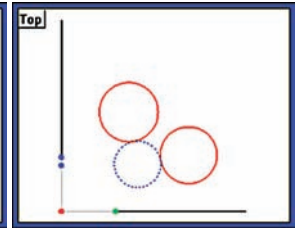

Tangent 2

Right-click the Results window to display alternative features

## Arc constructions

Arcs can be constructed from:

- Points
- Lines
- Circles
- Slots
- Distances
- Arcs
- Blobs

### ***Arc constructed from an arc***

A duplicate feature can be useful when it becomes desirable to perform new operations with the arc while retaining the original feature. Select the desired arc feature, click Measure Arc and then click OK. The new arc feature will be constructed and will be shown in the Features template, Part View window and Results window.

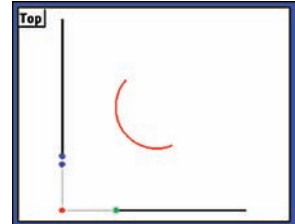

### ***Arc constructed from multiple features***

An arc feature can be constructed from any number of parent features. The parent features can be any combination of points, slots, arcs, circles and blobs. The center points of the parent features will be used to construct the new arc feature. Select the desired features, click Measure arc and then click OK. The new arc feature will be constructed and will be shown in the Features template, Part View window and Results window.

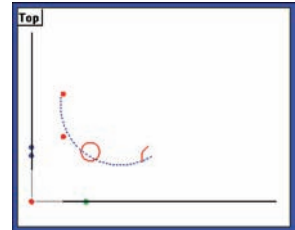

### ***Arc constructed from an arc and a distance***

An offset arc can be constructed from arc and distance parent features. Select the desired arc and distance features, click Measure Arc and then click OK. An arc equal to the parent arc will be constructed, offset the amount equal to the distance parent and will be shown in the Features template, Part View window and Results window.

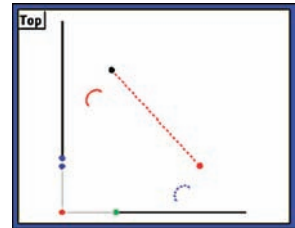

## Angle constructions

Angles can be constructed from:

- An angle
- Two lines

### Angle constructed from an angle

A duplicate feature can be useful when it becomes desirable to perform new operations with the angle while retaining the original feature. Select the desired angle feature, click Measure Angle and then click OK. The new angle feature will be constructed and will be shown in the Features template, Part View window and Results window.

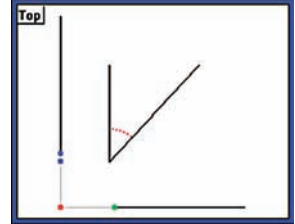

### Angle constructed from two lines

Select the desired line features, click Measure Angle and then click OK. The angle feature will be constructed and will be shown in the Features template, Part View window and Results window. Right-click the Results window to select a different circle feature type.

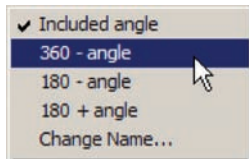
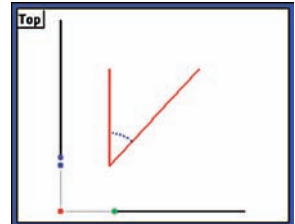

Right-click the Results window to display alternative features

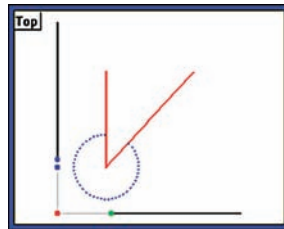

360 - angle

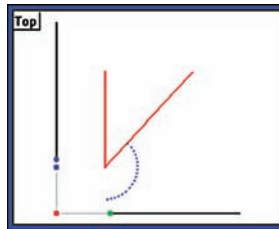

180 - angle

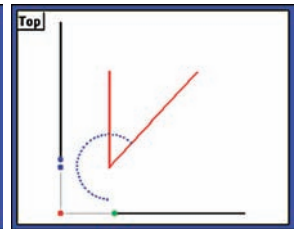

180 + angle

## Creating features

Features can be created by entering information that describes feature size and position. Information can be entered in Cartesian or polar coordinates, and in metric or English units of measure.

The following feature types can be created:

- Points
- Lines
- Distances
- Circles
- Arcs

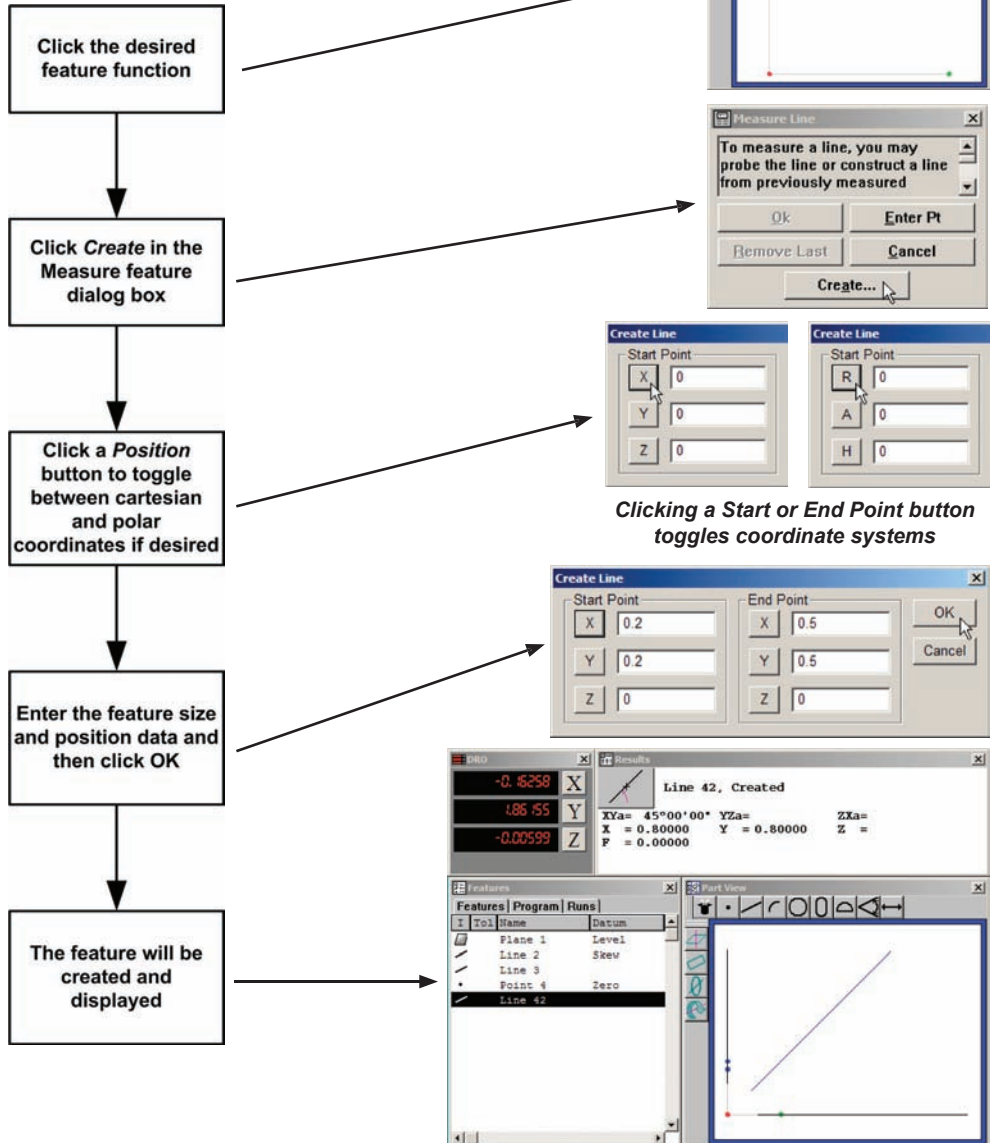

### Creating a point

To create a point:

- 1 Click Measure point, and then click Create in the Measure feature dialog box. The Create Point dialog box will be displayed.

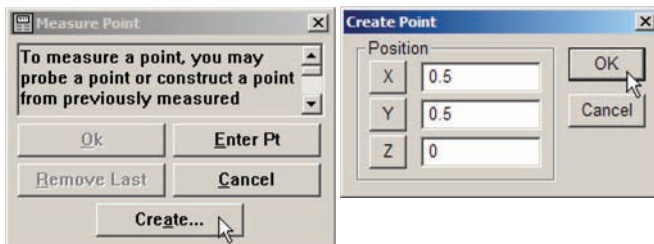

- 2 Click the X or Y button icon to toggle to polar coordinates if desired.
- 3 Enter the feature data in the fields provided and click OK.

The point will be created and displayed in the Features template, Part View window and Results window.

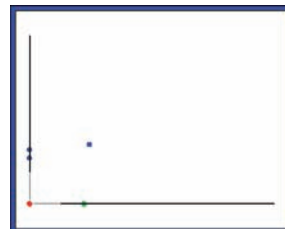

### Creating a line

To create a line:

- 1 Click Measure Line, and then click Create in the Measure feature dialog box. The Create Line dialog box will be displayed.
- 2 Click the X or Y button icon to toggle to polar coordinates if desired.
- 3 Enter the feature data in the fields provided and click OK.

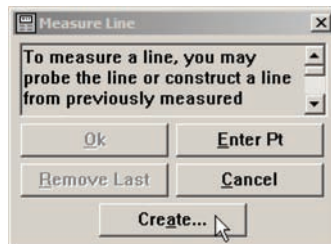

The line will be created and displayed in the Features template, Part View window and Results window.

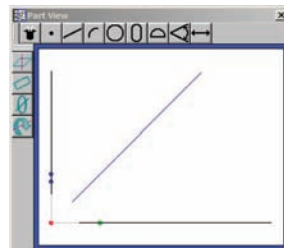
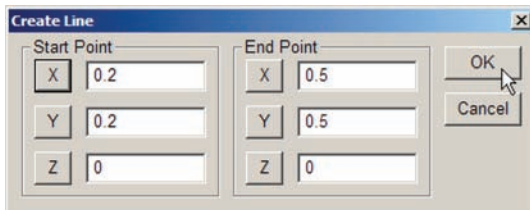

## Creating a distance

To create a distance:

- 1 Click Measure Distance, and then click Create in the Measure feature dialog box. The Create Distance dialog box will be displayed.
- 2 Click the X or Y button icon to toggle to polar coordinates if desired.
- 3 Enter the feature data in the fields provided and click OK.

The distance will be created and displayed in the Features template, Part View window and Results window.

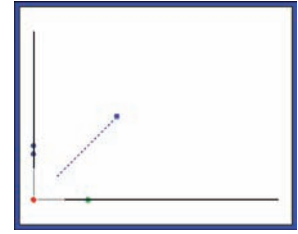
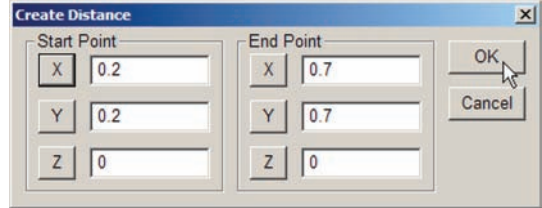
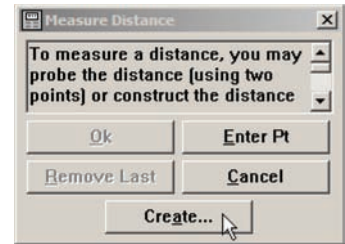

## Creating a circle

To create a circle:

- 1 Click Measure Circle, and then click Create in the Measure feature dialog box. The Create Circle dialog box will be displayed.
- 2 Click the X or Y button icon to toggle to polar coordinates if desired.
- 3 Enter the feature data in the fields provided and click OK.

The circle will be created and displayed in the Features template, Part View window and Results window.

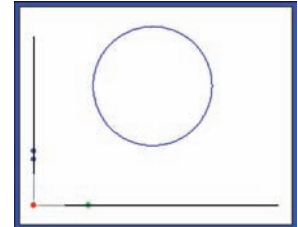
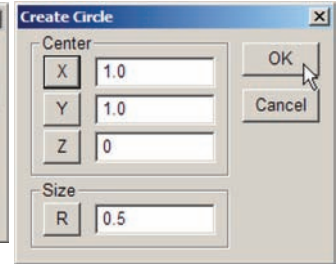
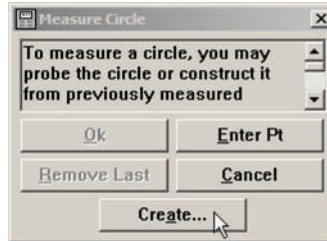



## Creating an arc

To create an arc:

- 1 Click Measure Arc, and then click Create in the Measure feature dialog box. The Create Arc dialog box will be displayed.
- 2 Click the X or Y button icon to toggle to polar coordinates if desired.
- 3 Enter the feature data in the fields provided and click OK.

The arc will be created and displayed in the Features template, Part View window and Results window

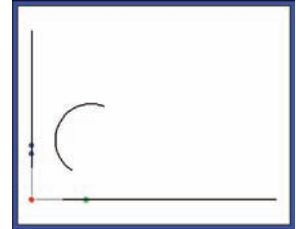
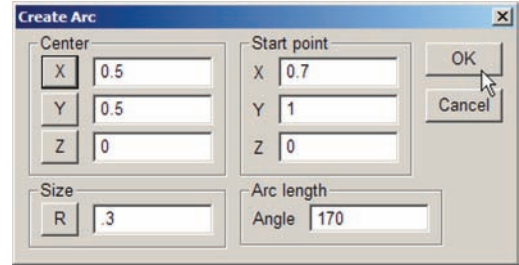
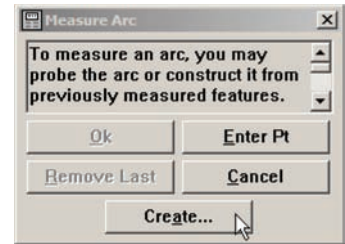

# Chapter 6: Tolerancing

Tolerances can easily be applied to position, size, orientation, form, runout and concentricity measurements using the on-screen menu or the Tolerance toolbar.



## CAUTION

Discrete point measuring machines estimate the size, position, orientation, and form of geometric features based on points probed. When parts are designed with critical tolerances, be sure that you have probed sufficient points to calculate a reliable estimate. For example, if you probe a circle with only three points, the circularity will be perfect and the circle will always pass a form tolerance test.



## CAUTION

The QC5200 uses a “best fit” program to estimate the size, position, orientation and form of geometric features. While the best fit yields very useful information, the results do not necessarily reflect how well the parts will fit together and perform their function. For example, a hole diameter could be calculated as 10.000 mm but have poor form. In this case, a 9.9 mm pin might not fit in the hole.



## NOTE

Tolerance calculations comply with the ASME Y14.5M-1994 standard except as noted in [Appendix C: Tolerances](#).

This chapter includes the following tolerance information:

Applying tolerances to features.....	203
Tolerance screens.....	203
Tolerance menu.....	204
Tolerance toolbar.....	204
Display of tolerance results.....	205
Naming and saving tolerances.....	206
Deleting Named Tolerances.....	206
Tolerance types.....	207
Bidirectional.....	207
True position.....	208
MMC/LMC (Material condition).....	209
Runout.....	210
Circularity.....	211
Straightness.....	211
Concentricity.....	211
Profile.....	212
Parallelism.....	213
Perpendicularity.....	213
Angularity.....	213
Angle.....	214
Width.....	214

# Applying tolerances to features

Tolerances are applied using tolerance entry screens. Tolerance entry screens are displayed using on-screen Tolerance menus or the Tolerance toolbar.

## Tolerance screens

While most screens have some unique characteristics that support the entry of specific types of tolerance data, tolerance entry screens also have many similarities. A few important similarities include the entry options for position, size and nominal values.

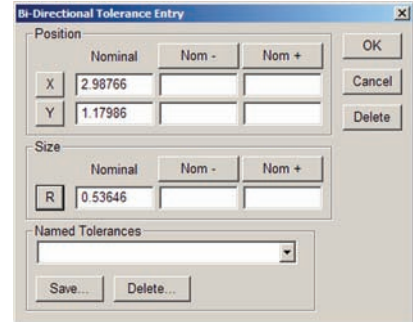

*Bi-directional Tolerance Entry screen*

Tolerances of position can be entered in cartesian or polar coordinate. The position data type can be toggled between cartesian and polar coordinates by clicking a coordinate button.

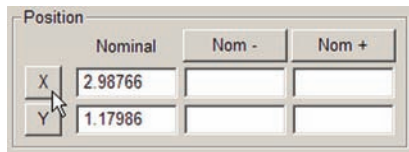

*Clicking a coordinate button...*

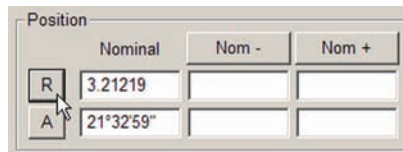

*toggles the coordinate system*

Arc and circle tolerances of size can be entered as a radius or diameter. The size data type can be toggled between radius and diameter by clicking a radius or diameter button.



*Clicking a radius or diameter button...*



*toggles the size data type*

Nominal value tolerances can be entered as +/- nominal ranges or as limits. The nominal value type can be toggled between +/- nominal ranges and nominal limits by clicking a Nom or Limit button.

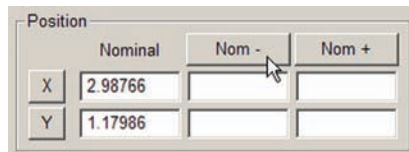

*Clicking a nominal value button...*

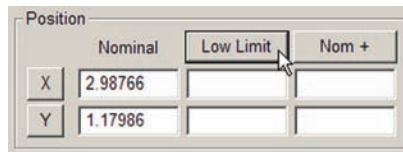

*toggles the nominal value type*

The individual tolerance screens for tolerance types are described in the Tolerance Types section later in this chapter.

## Tolerance menu

The on-screen Tolerance menu is displayed by highlighting a feature or group of features of identical type in the Feature or Program template, right-clicking the Results window and then clicking the Tolerance menu item.

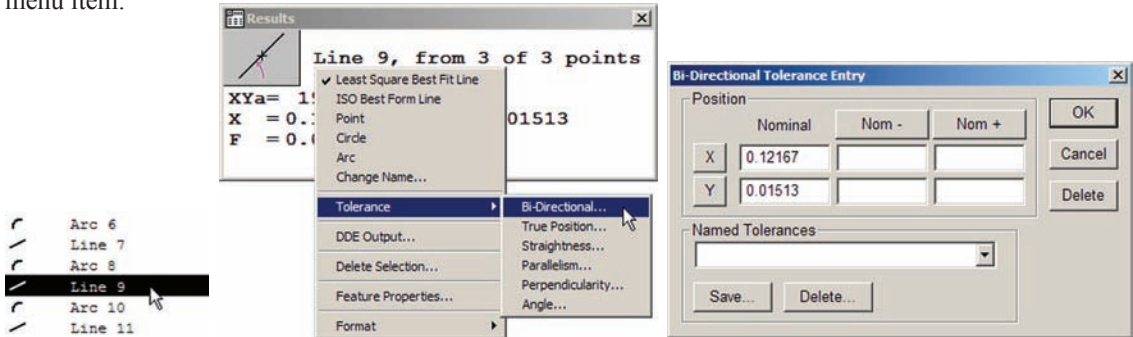

Select a feature... Right-click the Results window and select the desired tolerance...

and then enter tolerance data

The desired tolerance is then applied by clicking the tolerance type, providing the required data in the Tolerance Entry screen provided and clicking OK.

## Tolerance toolbar

The Tolerance toolbar is displayed by clicking the View/Toolbars menu item, highlighting Tolerance, clicking the Show button and then clicking OK.

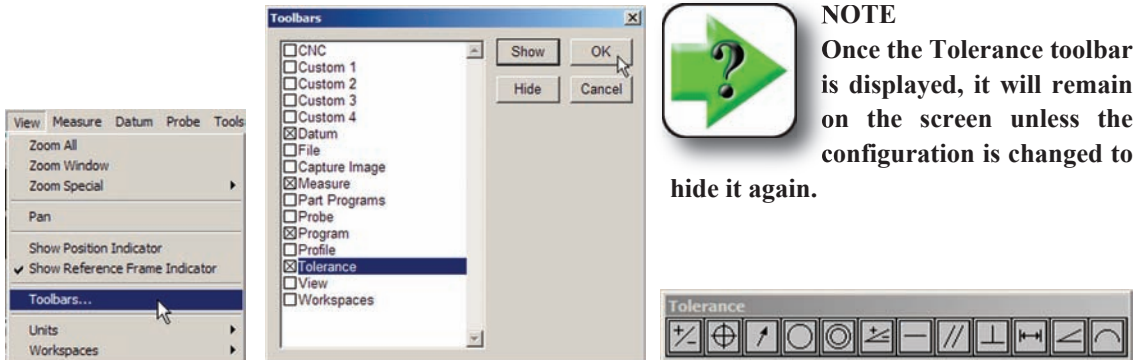

Click View/Toolbars...

select the Tolerance toolbar, click Show and then click OK...

to display the Tolerance toolbar

### NOTE



Once the Tolerance toolbar is displayed, it will remain on the screen unless the configuration is changed to

hide it again.

The desired tolerance is then applied by highlighting a feature or group of features of identical type in the Feature or Program template, clicking the tolerance toolbar button and providing the required data in the Tolerance Entry screen provided.

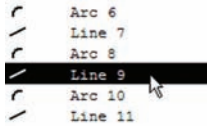

Select a feature...



Select the desired tolerance...

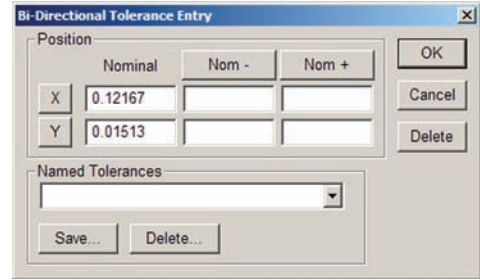

and then enter tolerance data



**NOTE**

When a tolerance data field is left blank, the system will ignore the field. For example, entering an X position tolerance, but leaving the Y position tolerance field blank will result in a tolerance test of only the X position.

## Display of tolerance results

When the tolerance is applied to the selected feature measurement, the results will be shown in the Tolerance Results dialog box, and in the feature list.

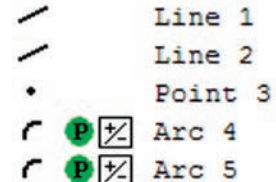
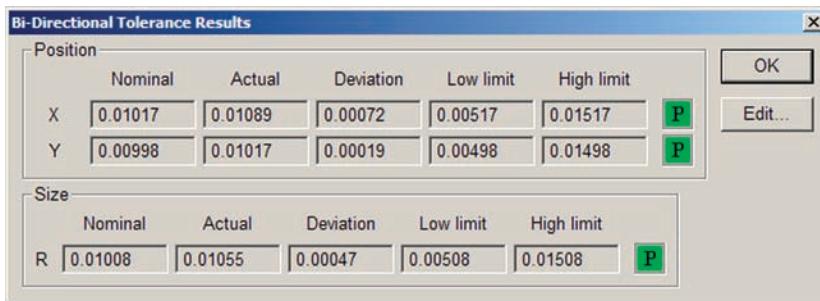

Tolerance results are shown by numeric data, pass/fail icons and tolerance type icons

The Tolerance Results dialog box displays the numeric data and pass or fail icons. The tolerance requirements can be edited by clicking the Edit button. The Feature list displays the pass or fail icon and an icon that indicates the tolerance type.

## Naming and saving tolerances

Tolerances for specific feature types can be saved with user-specified names. This is useful when identical tolerance parameters must be applied to multiple features. Enter the tolerance data into the Tolerance entry dialog box and then click Save. The Save Named Tolerance dialog box will be displayed.

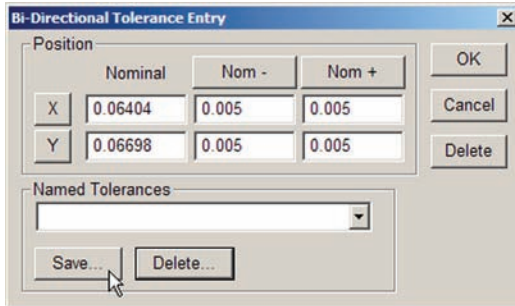

The **Bi-Directional Tolerance Entry** dialog box is shown. It has a title bar with a close button. Below the title bar is a section labeled "Position" containing a table with columns for "Nominal", "Nom -", and "Nom +". The rows are for "X" and "Y". The "Nominal" values are 0.06404 for X and 0.06698 for Y. The "Nom -" and "Nom +" values are both 0.005 for both X and Y. To the right of the table are buttons for "OK", "Cancel", and "Delete". Below the table is a "Named Tolerances" section with a drop-down list that is currently empty. At the bottom left of this section are "Save..." and "Delete..." buttons. A mouse cursor is pointing at the "Save..." button.

Position	Nominal	Nom -	Nom +
X	0.06404	0.005	0.005
Y	0.06698	0.005	0.005

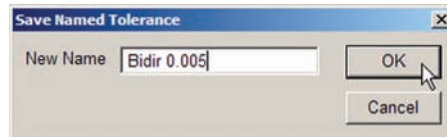

The **Save Named Tolerance** dialog box is shown. It has a title bar with a close button. Below the title bar is a "New Name" field containing the text "Bidir 0.005". To the right of the field are buttons for "OK" and "Cancel". A mouse cursor is pointing at the "OK" button.

Enter the desired tolerance name and then click OK. The new tolerance will appear in the Named Tolerance drop-down list, and can be selected and applied later to other features of this type.

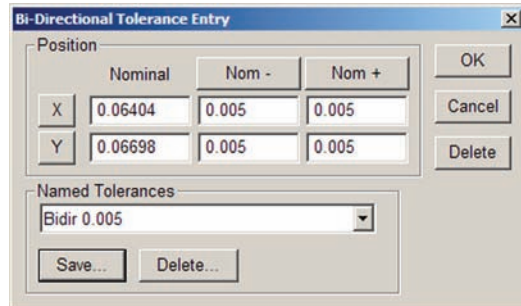

The **Bi-Directional Tolerance Entry** dialog box is shown again. The "Named Tolerances" section now has a drop-down list with "Bidir 0.005" selected. The "Save..." and "Delete..." buttons are visible below the list.

Position	Nominal	Nom -	Nom +
X	0.06404	0.005	0.005
Y	0.06698	0.005	0.005

## Deleting Named Tolerances

Tolerances in the Named Tolerances drop-down list can be deleted by selecting them and clicking the Delete button.

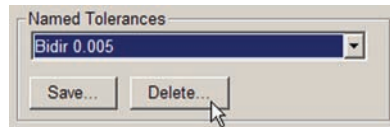

A close-up of the "Named Tolerances" section of the dialog box. The drop-down list shows "Bidir 0.005" selected. Below the list are "Save..." and "Delete..." buttons. A mouse cursor is pointing at the "Delete..." button.

## Tolerance types

The methods of applying tolerances to features described earlier are identical for all tolerances and feature types, only the required tolerance data changes from featured to feature. This section describes the tolerance (data) entry screen for each tolerance type. The following tolerances can be applied to features:

- Bidirectional
- True position
- MMC
- LMC
- Runout
- Circularity
- Concentricity
- Straightness
- Profile
- Parallelism
- Perpendicularity
- Angularity
- Angle
- Width

### ***Bidirectional***

Bidirectional tolerances can be applied to points, lines, arcs, circles and slots.

#### **Points and lines**

The tolerance entry screens for points and lines are identical, and are used to specify the acceptable deviation from nominal position in the X and Y axes. The bidirectional tolerance compares the measured location of a point or the center point of a line to the nominal location of the feature's center point.

Enter the nominal (-) and nominal (+) values into the X and Y axis data fields provided and then click OK.

Position			
	Nominal	Nom -	Nom +
X	3.4935		
Y	1.0162		

Named Tolerances:

Buttons: Save..., Delete..., OK, Cancel, Delete

#### **Arcs and circles**

The tolerance entry screens for arcs and circles are identical, and are used to specify the acceptable deviation from nominal position in the X and Y axes, and from the nominal radius. The bidirectional tolerance compares the measured location of the center point of the arc or circle to the nominal center point and compares the measured radius to the nominal radius.

Enter the nominal (-) axis, nominal (+) axis and nominal radius values into the data fields provided and then click OK.

Position			
	Nominal	Nom -	Nom +
X	2.9901		
Y	1.1984		

Named Tolerances:

Buttons: Save..., Delete..., OK, Cancel, Delete

Size			
	Nominal	Nom -	Nom +
R	0.2475		



### Slots

The tolerance entry screens for slots are used to specify the acceptable deviation from nominal position in the X and Y axes, and from the nominal slot size in length and width. The bidirectional tolerance compares the measured location of the center point of the slot to the nominal center point and compares the measured size to the nominal size.

Enter the nominal (-) axis, nominal (+) axis, nominal Length and nominal Width values into the data fields provided and then click OK.

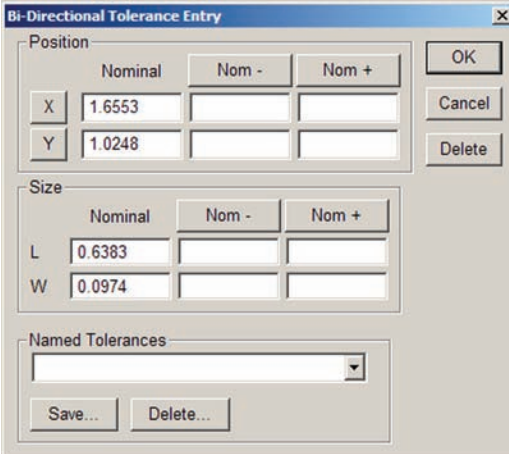

The Bi-Directional Tolerance Entry dialog box is used for specifying tolerances for slots. It contains the following fields and controls:

- Position:** A table with columns for Nominal, Nom -, and Nom +. The X-axis has a value of 1.6553, and the Y-axis has a value of 1.0248.
- Size:** A table with columns for Nominal, Nom -, and Nom +. The Length (L) is 0.6383 and the Width (W) is 0.0974.
- Named Tolerances:** A dropdown menu with a Save... button and a Delete... button.
- Buttons:** OK, Cancel, and Delete buttons are located on the right side.

### True position

True position tolerances can be applied to points, lines, arcs, circles and slots.

#### Points and lines

The tolerance entry screens for points and lines are identical, and are used to specify the acceptable deviation from the nominal feature position. The true position tolerance compares the measured location of the center point to the nominal center point.

Enter the acceptable position deviation value into the Tol Zone data field provided and then click OK.

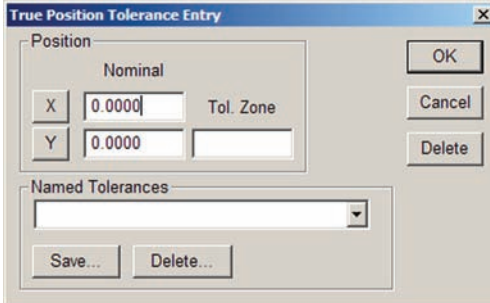

The True Position Tolerance Entry dialog box for points and lines contains the following fields and controls:

- Position:** A table with columns for Nominal and Tol. Zone. The X-axis has a value of 0.0000, and the Y-axis has a value of 0.0000.
- Named Tolerances:** A dropdown menu with a Save... button and a Delete... button.
- Buttons:** OK, Cancel, and Delete buttons are located on the right side.

#### Arcs and circles

The tolerance entry screens for arcs and circles are identical, and are used to specify the acceptable deviation from the nominal feature position, and from the nominal radius. The true position tolerance compares the measured location of the center point of the arc or circle to the nominal center point and compares the measured radius to the nominal radius.

Enter the acceptable position deviation value and the nominal radius values into the data fields provided and then click OK.

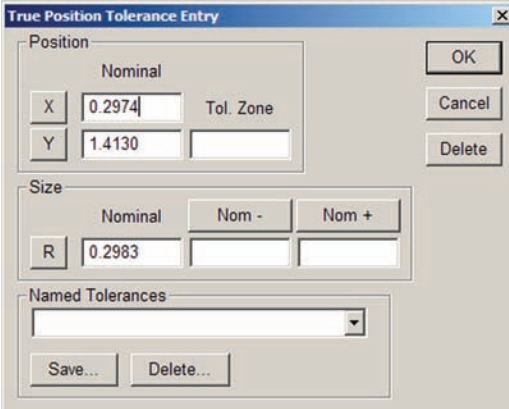

The True Position Tolerance Entry dialog box for arcs and circles contains the following fields and controls:

- Position:** A table with columns for Nominal and Tol. Zone. The X-axis has a value of 0.2974, and the Y-axis has a value of 1.4130.
- Size:** A table with columns for Nominal, Nom -, and Nom +. The Radius (R) is 0.2983.
- Named Tolerances:** A dropdown menu with a Save... button and a Delete... button.
- Buttons:** OK, Cancel, and Delete buttons are located on the right side.

## Slots

The tolerance entry screens for slots are used to specify the acceptable deviation from nominal position, and from the nominal slot size in length and width. The true position tolerance compares the measured location of the center point of the slot to the nominal center point and compares the measured size to the nominal size.

Enter the acceptable position deviation value, nominal Length and nominal Width values into the data fields provided and then click OK.

## MMC/LMC (Material condition)

MMC and LMC tolerances are be applied to bosses or to bores, compare measured center locations to the nominal centers and compare measured radii to nominal radii. MMC and LMC tolerances can be applied with or without Reference (datum) features. MMC and LMC tolerances can be applied to arcs and circles.

### MMC Arcs and Circles

The MMC tolerance entry screens for arcs and circles are identical, and are used to specify the maximum material that can exist within a bore or on the surface of a boss.

MMC tolerances can generate position bonuses as a result of size tolerance surpluses. For example, when the size of a bore is larger than MMC, but within the acceptable tolerance range, a position tolerance bonus is generated for the bore and its acceptable location is given more flexibility. However, if a bore is exactly the MMC size, no position bonus is generated and the bore must be located exactly as specified. When a Reference feature is used and found to have a tolerance surplus, it also generates a position tolerance bonus for the bore.

Select the feature type as a Boss or a Bore, enter the acceptable position Tol Zone value, enter the nominal radius value, select a Reference feature if required and then click OK. Reference features of MMC are discussed in [Appendix C: Tolerances](#).

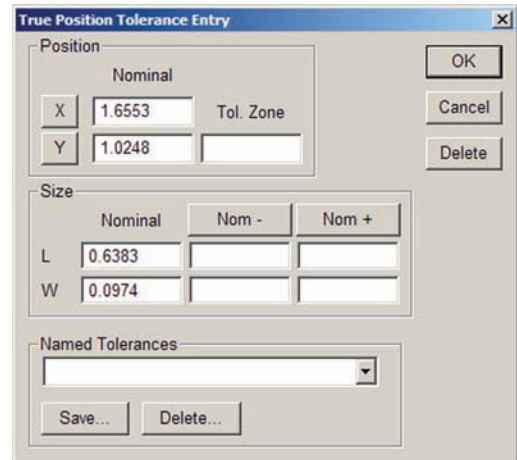

The True Position Tolerance Entry dialog box is used to specify position and size tolerances for slots. It contains the following fields and controls:

- Position:** Nominal, X (1.6553), Tol. Zone, Y (1.0248).
- Size:** Nominal, Nom -, Nom +, L (0.6383), W (0.0974).
- Named Tolerances:** A dropdown menu with Save... and Delete... buttons.
- Buttons:** OK, Cancel, Delete.

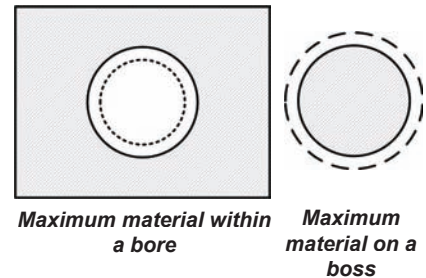
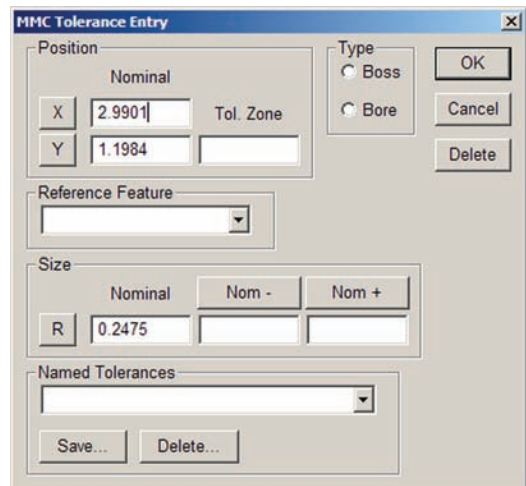
The MMC Tolerance Entry dialog box is used to specify MMC tolerances for arcs and circles. It contains the following fields and controls:

- Position:** Nominal, X (2.9901), Tol. Zone, Y (1.1984).
- Type:** Boss (selected), Bore.
- Reference Feature:** A dropdown menu.
- Size:** Nominal, Nom -, Nom +, R (0.2475).
- Named Tolerances:** A dropdown menu with Save... and Delete... buttons.
- Buttons:** OK, Cancel, Delete.

## LMC

The LMC tolerance entry screens for arcs and circles are identical, and are used to specify the minimum material that can exist within a bore or on the surface of a boss.

LMC tolerances can generate position bonuses as a result of size tolerance surpluses. For example, when the size of a bore is smaller than LMC, but within the acceptable tolerance range, a position tolerance bonus is generated for the bore and its acceptable location is given more flexibility. However, if a bore is exactly the LMC size, no position bonus is generated and the bore must be located exactly as specified. When a Reference feature is used and found to have a tolerance surplus, it also generates a position tolerance bonus for the bore.

Select the feature type as a Boss or a Bore, enter the acceptable position Tol Zone value, enter the nominal radius value, select a Reference feature if required and then click OK. Reference features of LMC are discussed in [Appendix C: Tolerances](#).

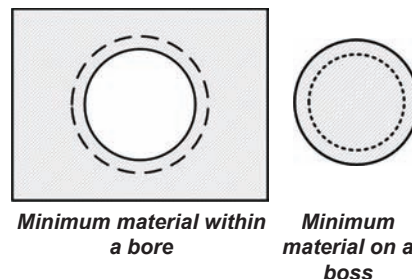

## Runout

Runout tolerances can be applied to arcs and circles. The tolerance entry screens are identical, and are used to specify the acceptable deviation from a circle around the center of the Reference feature axis.

Enter the acceptable position deviation value into the Tol Zone data field provided and then click OK.

### **Circularity**

Circularity tolerances can be applied to arcs and circles. The tolerance entry screens are identical, and are used to specify the acceptable deviation from a perfect circle.

Enter the acceptable position deviation value into the Tol Zone data field provided and then click OK.

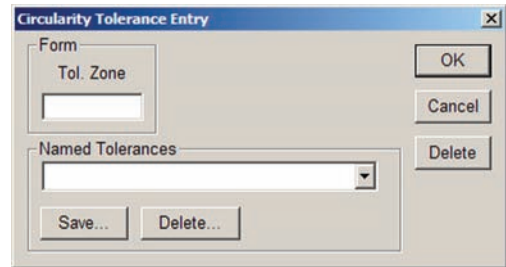

The dialog box is titled "Circularity Tolerance Entry". It contains a "Form" section with a "Tol. Zone" text input field. To the right of this section are three buttons: "OK", "Cancel", and "Delete". Below the "Form" section is a "Named Tolerances" section with a dropdown menu. At the bottom of the dialog are two buttons: "Save..." and "Delete...".

### **Straightness**

The straightness tolerance can be applied to lines and is used to specify the acceptable deviation from a perfect line.

Enter the acceptable position deviation value into the Tol Zone data field provided and then click OK.

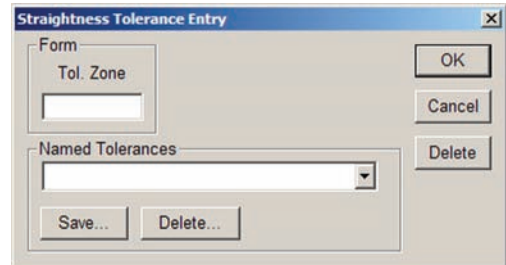

The dialog box is titled "Straightness Tolerance Entry". It contains a "Form" section with a "Tol. Zone" text input field. To the right of this section are three buttons: "OK", "Cancel", and "Delete". Below the "Form" section is a "Named Tolerances" section with a dropdown menu. At the bottom of the dialog are two buttons: "Save..." and "Delete...".

### **Concentricity**

Concentricity tolerances can be applied to arcs and circles. The tolerance entry screens are identical, and are used to specify the acceptable deviation from a circle concentric to a Reference feature.

Enter the acceptable position deviation value into the Tol Zone data field provided and then click OK.

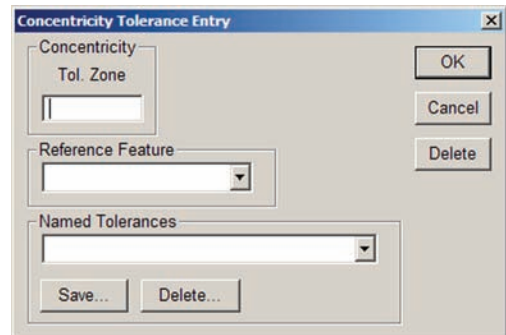

The dialog box is titled "Concentricity Tolerance Entry". It contains a "Concentricity" section with a "Tol. Zone" text input field. To the right of this section are three buttons: "OK", "Cancel", and "Delete". Below the "Concentricity" section is a "Reference Feature" section with a dropdown menu. At the bottom of the dialog are two buttons: "Save..." and "Delete...".

## Profile

The profile tolerance can be applied to profile features and is used to specify the acceptable material deviation outside and inside the nominal part profile. Tolerances can be specified as bilateral (equal) or as non-bilateral (unequal).

### Equal bilateral tolerances

Bilateral tolerance zone will be centered around the edges of the nominal profile. For example, an equal bilateral tolerance of 0.005 will be applied as  $\pm 0.0025$ .

Check the Bilateral box and enter the desired tolerance value into the Tolerance data field for equal bilateral tolerances.

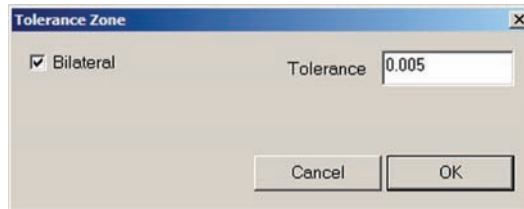

*An equal bilateral tolerance of 0.005 is applied as...*

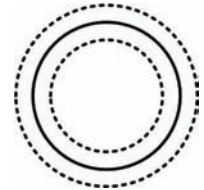

$\pm 0.0025$

### Unequal tolerances

Unequal bilateral or unilateral tolerance values are specified by the user for In-material tolerance and Out-material tolerances. This example shows a boss with different In-material and Out-material tolerances.

Clear the Bilateral box and enter the desired In-material and Out-material tolerance values in the data fields provided.

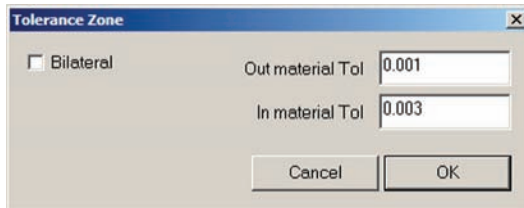

*Unequal bilateral tolerances are applied as...*



$+0.003$  and  $-0.001$

Tolerances can be applied to up to 5 different (Form) areas of the part profile. To apply a tolerance to an area, select the area using the mouse cursor in the Measure Profile window, then apply a tolerance as shown above. Tolerance (Form) areas can be displayed and edited by clicking the Tools/Tolerance/Profile menu item.

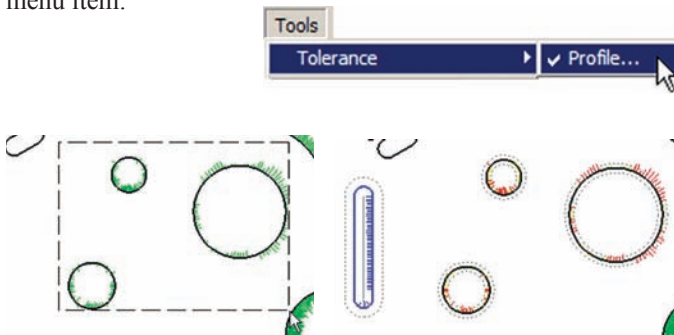

*Selected areas...*

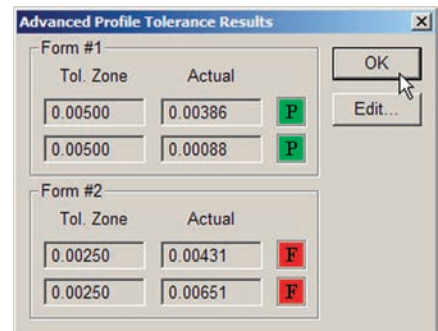

*can be assigned different tolerances that are shown and edited in the Advanced Profile Tolerance Results screen*

## Parallelism

Parallelism tolerances can be applied to lines and are used to specify the acceptable deviation from a line perfectly parallel to a Reference feature. Minimum and Maximum Projected zone values are added to the feature length to continue the test of parallelism beyond the line end.

Enter the acceptable parallelism deviation value into the Tol Zone data field, select a Reference feature from the drop-down list, add any Projected Zone values and then click OK. Projected zones are discussed in [Appendix C: Tolerances](#).

## Perpendicularity

Perpendicularity tolerances can be applied to lines and are used to specify the acceptable deviation from a line perfectly perpendicular to a Reference feature. Minimum and Maximum Projected zone values are added to the feature length to continue the test of perpendicularity beyond the line end.

Enter the acceptable perpendicularity deviation value into the Tol Zone data field, select a Reference feature from the drop-down list, add any Projected Zone values and then click OK. Projected zones are discussed in [Appendix C: Tolerances](#).

## Angularity

Angularity tolerances can be applied to angles and are used to specify the acceptable deviation from a Nominal angle made between two lines selected in the Features list. The line closest to the top of the list is the reference for the measurement. Minimum and Maximum Projected zone values are added to the feature length to continue the test of angularity beyond the end of the angle.

Enter the acceptable angularity deviation value into the Tol Zone data field, add any Projected Zone values, enter a nominal angle and then click OK. Projected zones are discussed in [Appendix C: Tolerances](#).

## Angle

Angle tolerances can be applied to lines and angles. The tolerance entry screens are identical, and are used to specify the acceptable deviation from a nominal angle.

### Lines

The tolerance entry screen is used to specify the acceptable deviation from a nominal angle made between the line feature and the part skew line.

Enter the Nominal angle, the acceptable Nom - and Nom + angle deviation values and then click OK.

### Angles

The tolerance entry screen is used to specify the acceptable deviation from a nominal angle.

Enter the Nominal angle, the acceptable Nom - and Nom + angle deviation values and then click OK.

## Width

Width tolerances can be applied to distances and are used to specify the acceptable deviation from a nominal length. The length can be specified as a vector length or as separate X and Y lengths.

Enter the Nominal Length, the acceptable Nom - and Nom + Length deviation values or enter Nominal X/ Y, Nom ±X and Nom ±Y values and then click OK.

# Chapter 7:

## Reporting & templates

Templates display measurement results, show program content and organize data for printed reports and exported files. QC5200 templates include the:

- Feature template List of features measured
- Program template Listing of program steps
- Runs template Table of results of program executions (Runs) formatted for file export
- Report template Table of results formatted for printed reports
- Tolerance templates Tables of tolerance measurement results in a few commonly used formats

The default templates are formatted to fill most typical requirements, however templates can be edited to:

- Add or delete data
- Sort the order of data displayed
- Format data columns
- Include headers and footers
- Edit and format headers and footers

Multiple copies of templates can be opened, renamed and formatted to fill specific requirements. Templates are stacked in a single window by default to conserve screen space.

Finally and perhaps most importantly, the contents of templates can be printed as reports or exported as data files.



The following information regarding reporting and templates is contained in this chapter:

Template descriptions .....	217
Features template .....	217
Program template .....	218
Runs template .....	219
Runs charts .....	220
Report template .....	222
Tolerance templates .....	223
Opening templates .....	224
Generating new default templates .....	224
Editing templates .....	225
Adding and deleting data .....	225
Adding data .....	225
Deleting data .....	229
Sorting data within a column .....	230
Aligning column titles and data .....	231
Changing the order of columns .....	231
Displaying horizontal and vertical grid lines .....	231
Headers and footers .....	232
Showing headers and footers .....	232
Editing headers and footers .....	233
Adding text .....	233
Editing text .....	233
Formatting text .....	234
Including automatic text entry .....	235
Prompting the user for alphanumeric information .....	235
Deleting text .....	236
Enabling text to speech output .....	236
Adding graphics from files .....	236
Drawing graphics .....	238
Printing reports .....	241
Exporting data .....	242
DDE Output .....	243
Output parameters .....	243
Connection .....	243
Data .....	244
General guidelines .....	244

## Template descriptions

Basic descriptions are included for the following templates:

- Feature template
- Program template
- Runs template
- Report template
- Tolerance templates

### Features template

The Features template displays a list of all features measured during a work session or during one program run.



#### NOTE

The contents of the Features template is cleared by the system at the beginning of each program run.

I	Tol	Name	Datum
/		Line 1	Skew
/		Line 2	
•		Point 3	Zero
⌒		Arc 4	
○		Circle 5	
/		Line 6	
•		Point 7	
0		Slot 8	

The default Features template displays feature icons, tolerance pass/fail indications, tolerance type icons, feature names and the datum reference feature names.

Measurement data categories can be dragged and dropped into the Features template from the Results window to create new columns.

I	Tol	Name	Datum	d	X	Y	F
/		Line 1	Skew		1.13709	0.00000	0.00
/		Line 2			0.00000	0.83975	0.00
•		Point 3	Zero		0.00000	0.00000	0.00
⌒		Arc 4		1.08338	2.98178	1.17445	0.00
○		Circle 5		0.50338	3.01018	1.20665	0.01
/		Line 6			1.64029	1.71217	0.00
•		Point 7			1.69910	1.60108	0.00
0		Slot 8		0.10456	1.65989	1.03253	

As shown here, the organization of feature data is vertical. For example, X-position results for all features shown here are contained in the vertical “X” column.

The contents of the Features template can be printed, however the Report template generally provides a more efficient starting point for printed reports.

The contents of the Features template can be expanded to include results data categories and exported. However, the format of the Runs template might be more appropriate for exporting data because of its horizontal data orientation and because it contains a complete history of measurement results from all program runs. The features template would need to be exported after each program run because its contents is cleared at the beginning of each program run.

## Program template

The program template displays a list of program steps for the current part and is used to create, edit, debug and monitor part measurement programs.

The program template displays feature icons, pass/fail icons, tolerance type icons and program step actions.

Program steps are super-steps containing more than one action, or are simple steps containing only one action. Super-steps can be expanded to show subordinate steps by clicking the + sign in front of the step.

The contents of the Program template can be printed for evaluation at another location, but are sufficiently machine-specific to be of only limited value as a printout.

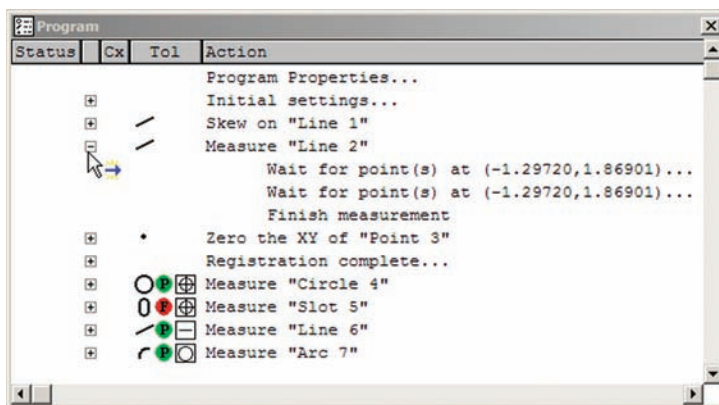

***A program super-step is expanded by clicking the + sign***

During program execution, the current step is indicated by a blue arrow and successfully completed steps are indicated by green check marks.

Please refer to [Chapter 8: Programming](#) for more details regarding the use of the Program template.

## Runs template

The Runs template defines the contents of the runs database, and then displays measurement data accumulated by program runs and stored in the database.

The default Runs template and database are empty and must be defined by dragging and dropping data fields into the template from the Results window.

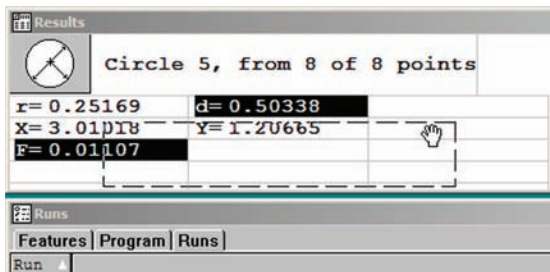

*Data fields are dragged and dropped from the Results window...*

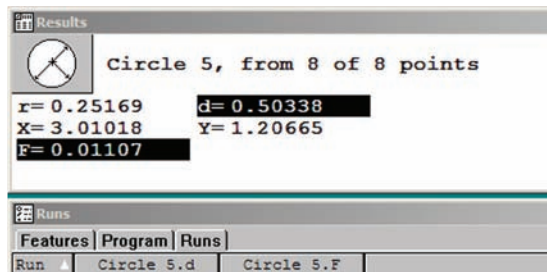

*into the Runs template as column headings*

As shown here, the organization of feature data in the Runs template is horizontal. The feature data for each run is contained in a horizontal row of the table.

The screenshot shows the 'Runs' window with a table of measurement data. The table has columns for 'Run', 'Circle 5.d', 'Circle 5.F', 'Arc 4.d', 'Arc 4.F', 'Line 6.XYa', and 'Line 6'. The data is organized horizontally, with each row representing a run and its associated measurements.

Run	Circle 5.d	Circle 5.F	Arc 4.d	Arc 4.F	Line 6.XYa	Line 6
3	0.50440	0.00875	1.08528	0.00787	179°52'56"	0.00
2	0.50239	0.00847	1.04958	0.00342	0°04'51"	0.01
1	0.50738	0.01456	1.07283	0.00727	0°00'00"	0.00

*The measurement data from each run is a horizontal row*

The Runs template displays data contained in the Runs database, organized in the manner specified by the user when data fields were dragged and dropped into the template from the Results window. However, multiple Runs templates can be opened, populated with data, formatted and renamed to fill many different data reporting requirements.

The maximum number of records stored in the Runs database is specified by the supervisor in the Tools/Options/Runs setup screen. Please refer to [Chapter 10: Supervisor Set up](#) for additional details regarding QC5200 setup.

Data is deleted from the Runs database by deleting rows or columns from the Runs template, as described later in this chapter.



### CAUTION

Delete Runs data with care, deleted data cannot be restored.

The contents of the Runs template can be printed, however the Reports template generally provides a more efficient starting point for printed reports.

The contents of the Runs template can be exported in a variety of file formats as described later in this chapter.

**NOTE**

If the Results window is locked using the Tools/Options/Locks functions, contents cannot be dragged from the window to a template.

**Runs charts**

Each category of feature data collected by the Runs database can be charted. The chart types include X Bar, R Bar, Simple Data and Histogram. In this example, charts will be displayed for the Arc 4 radius.

To display chart data:

1 Right-click the title of a data column and click the desired Charts menu item.

2 The Chart Setup dialog box will be presented. Enter the desired subgroup size, then evaluate the column data to find the highest and lowest values.

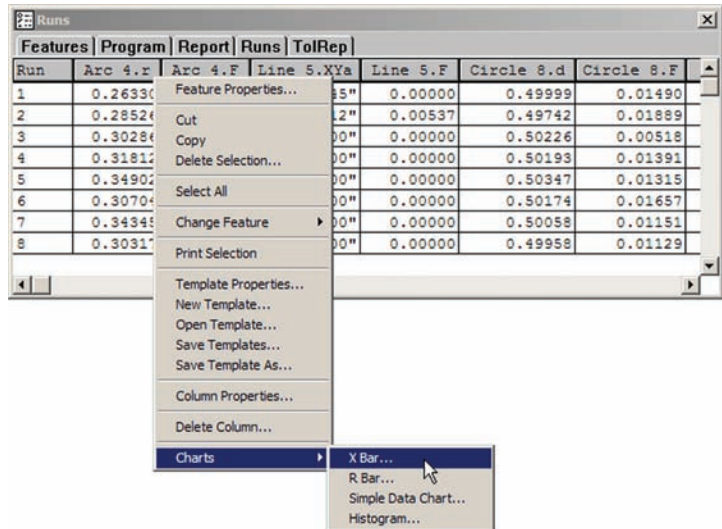
**NOTE**

Instructions for sorting data are provided later in this chapter.

Enter Lower and Upper Limit values slightly higher and lower than the highest and lowest values respectively, and then click OK.

The specified chart will be presented. The four chart types are shown on the next page.

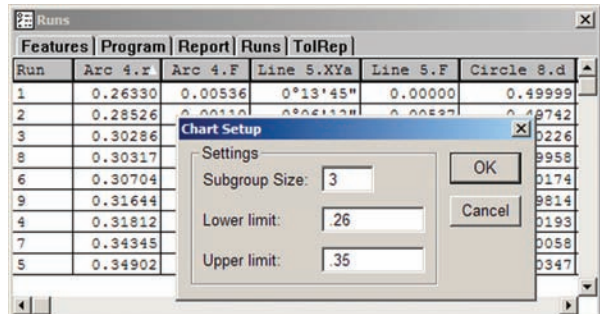

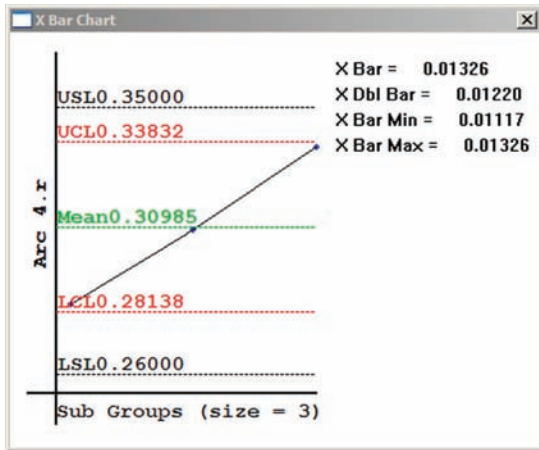

X Bar chart

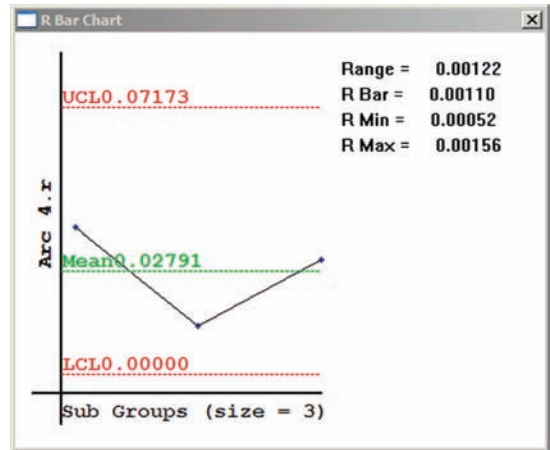

R Bar chart

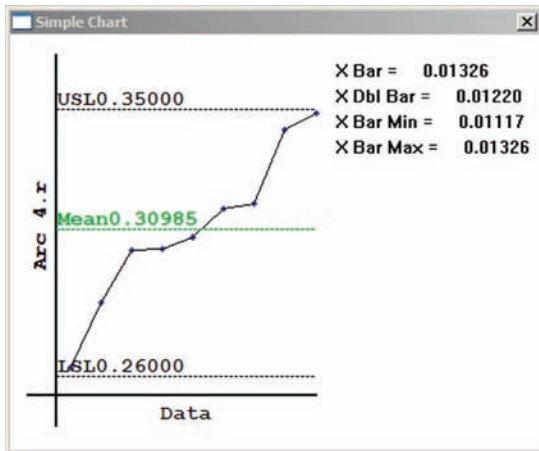

Simple data chart

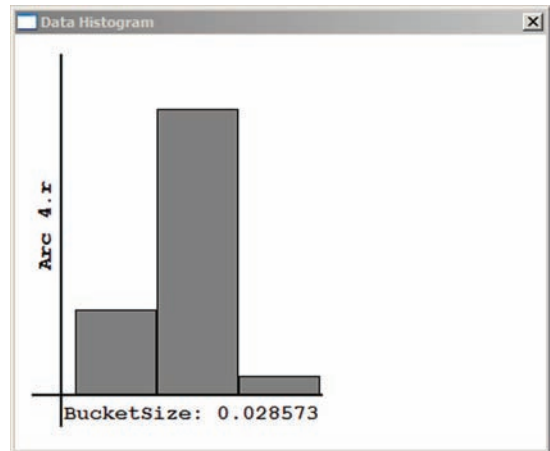

Histogram chart

## Report template

The Report template displays a table of features and related measurement data collected during a work session or during one program run. The Report template is configured and formatted to print reports of measurement results that satisfy most typical requirements.



### NOTE

The contents of the Report template is cleared by the system at the beginning of each program run.

QC5000 Feature Printout						
Time: <t>		Part: <n>		Operator: <u>		
Date: <d>		Job: <?1>				
#	Feature	Position/Dim.	Size	Orientation	Form/Dim.	Special
5	Slot 5	X	1.65852	d	0.10768	L3d 0.63448
		Y	1.02909	r	0.05384	
7	Arc 7	X	2.98766	d	1.07292	L3d 0.04967
		Y	1.17986	r	0.53646	
6	Line 6	X	1.65663			F 0.00000
		Y	1.71217			
4	Circle 4	X	3.00952	d	0.50408	F 0.01033
		Y	1.20640	r	0.25204	
3	Point 3	X	0.00000			F 0.00000
		Y	0.00000			
2	Line 2	X	0.00000			F 0.00000
		Y	0.85282			
1	Line 1	X	1.15016			F 0.00000
		Y	0.00000			

The default Report template displays feature ID numbers, feature names, position, size, orientation, form and dimension information such as length. The template also displays a report header that includes time, date, part number (part name by default), job number, and operator identification. All the header information is entered automatically by the computer except job number. The system prompts the user for a job number when the report is printed. Headers and footers can be edited to fill specific reporting requirements.



### NOTE

Configuration and formatting of template headers is discussed later in this chapter.

Additional measurement data categories can be dragged and dropped into the Report template from the Results window to create new columns.

As shown here, the organization of feature data is horizontal. For example, all results for a given feature are contained in a horizontal row. Table cells can contain multiple results.

QC5000 Feature Printout						
Time: 7:41		Part: 11A10999		Operator: us4126		
Date: 4/18		Job: 1				
#	Feature	Position/Dim.	Size	Orientation	Form/Dim.	Special
1	Line 1	X	1.15016			F 0.00000
		Y	0.00000			
2	Line 2	X	0.00000			F 0.00000
		Y	0.85282			
3	Point 3	X	0.00000			F 0.00000
		Y	0.00000			
4	Circle 4	X	3.00952	d	0.50408	F 0.01033
		Y	1.20640	r	0.25204	
5	Slot 5	X	1.65852	d	0.10768	L 0.63448
		Y	1.02909	r	0.05384	
6	Line 6	X	1.65663			F 0.00000
		Y	1.71217			
7	Arc 7	X	2.98766	d	1.07292	L 0.04967
		Y	1.17986	r	0.53646	

Page #1 of 1

*Typical Report template printout*

The contents of the Report template can be expanded to include additional results data categories and exported. However, the format of the Runs template might be more appropriate for exporting data because it contains a complete history of measurement results from all program runs. The Report template would need to be exported after each program run because its contents is cleared at the beginning of each program run.

## Tolerance templates

The Tolerance templates display table of features and related tolerance measurement data collected during a manual work session or during one program run. The Tolerance templates are configured and formatted to print reports of tolerance results in a few common formats for the Americas, Asia and Europe. The TolRep (tolerance report) template is shown in this description. The Tolerance templates are configured and formatted to print reports of tolerance results that satisfy most typical requirements.

T	Name	Actual/SPD	Nom/Zone	Dev/TPA	Min	Max/EPD	---/+++	Bonus/Ref
	Point 3	X 0.00000 Y 0.00000						
	Circle 4	X 3.00952 Y 1.20640 TP 0.00105 d 0.50408 f 0.01033	3.00991 1.20675 0.01000	-0.00039 -0.00035 222			.	
	Slot 5	X 1.65852 Y 1.02909 TP 0.01411 l 0.63448 w 0.10768	1.65989 1.03601 0.01000 0.64738 0.10456	-0.00137 -0.00692 259 -0.01290 0.00312	0.63738 0.65738 0.09456	0.00411 -0.00011	.+	
	Line 6	X 1.65663 Y 1.71217 f 0.00000 a 0°00'00"	0.01000				.	
	Arc 7	X 2.98766 Y 1.17986 r 0.53646 f 0.00273	0.01000				.+	



**NOTE**

The contents of the Tolerance templates are cleared by the system at the beginning of each program run.

The default Tolerance templates display feature names, pass/fail icons, tolerance icons, nominal values and tolerance results. The template can also displays a report header that includes time, date, part number, job number, and operator identification. All data and header information is entered automatically by the computer except job number. The system prompts the user for a job number when the report is printed. Headers and footers can be edited to fill specific reporting requirements.

Page #1 of 1

Typical Tolerance report template printout



**NOTE**

Configuration and formatting of template headers is discussed later in this chapter.

As shown here, the organization of feature tolerance data is horizontal. For example, all results for a given feature are contained in a horizontal row. Table cells can contain multiple results.

Please refer to [Chapter 6: Tolerancing](#) for additional details regarding tolerances.



## Opening templates

Templates can be opened by clicking the Windows/Open Template menu item, or by clicking the template name in the recently used area at the bottom of the menu.

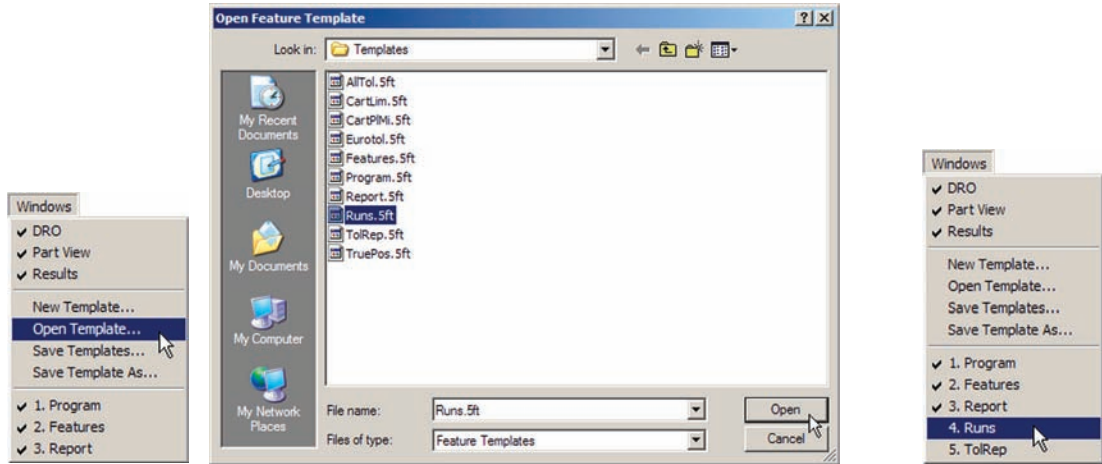

*Click Open Template, select the template name and click Open, or...*

*click the name*

## Generating new default templates

Sometimes it is advantageous to generate new templates with default properties. For example, when multiple template files of runs data is required to satisfy different requirements, multiple Runs templates can be generated, given unique names and configured to contain different data. Also, if columns were mistakenly deleted from a Report template, a new Report template could be generated to replace the original. To generate a new default template, click the Windows/New Template menu item, select a template type from the New Template Name list, enter a unique name into the File name field and click Save.

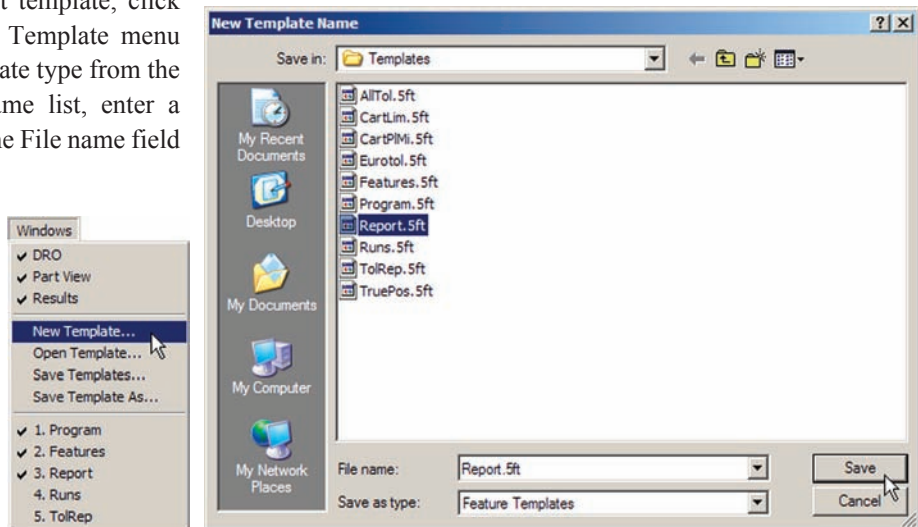

*Click New Template, select a template type, enter a unique name and click Save*

# Editing templates

Templates can be edited to:

- Add or delete data
- Sort the order of data displayed
- Format data columns
- Include headers and footers
- Edit and format headers and footers

## Adding and deleting data

Measurement result data can be added to or deleted from any template. The methods of adding and deleting data are identical for all templates.

### Adding data

Data can be added to any template by clicking and dragging data fields from the Results window to the template, unless the Results window is locked in the Tools/Options/Locks screen. Feature data is always added to the Runs template at least once, because the default Runs template is blank. Feature data might be added to the Feature template to satisfy the specific needs of a reporting requirement or a user display preference. However, it is unlikely that data fields will be added to the Program template since the default configuration of the template already includes the necessary information to perform all programming activities. It is also unlikely that data fields will be added to the Report or Tolerance templates since all feature measurements are included in the Report template and all tolerance results are included in the Tolerance templates by default.

Data can be added as individual fields or as a collection of fields into an existing column, a new single column or into new multiple columns. The process of adding data is diagrammed here.

Examples of adding data to the Feature template are shown on the next page. An example of adding data fields to the Runs template was provided earlier in this chapter as part of the Runs template description.

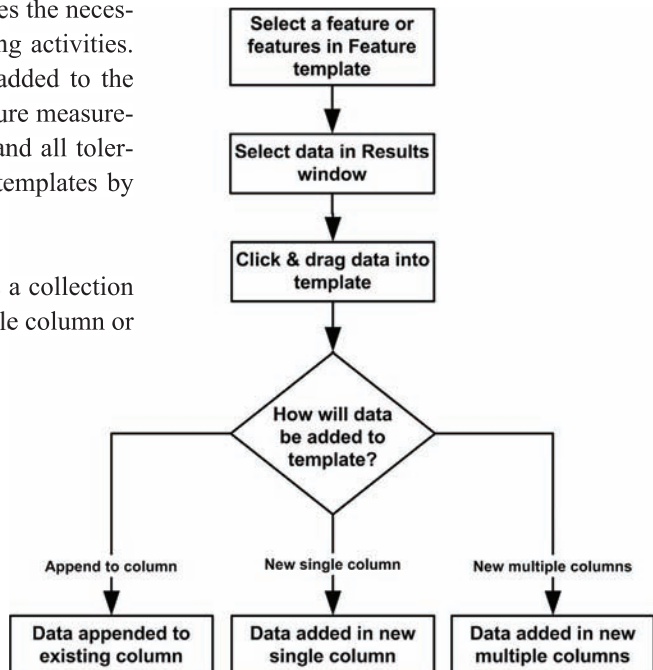

### Adding multiple data fields as a single new column

To add data fields to a template in a single new column:

- 1 Select the data in the Results window and then click and drag the selection to empty column space in the template.

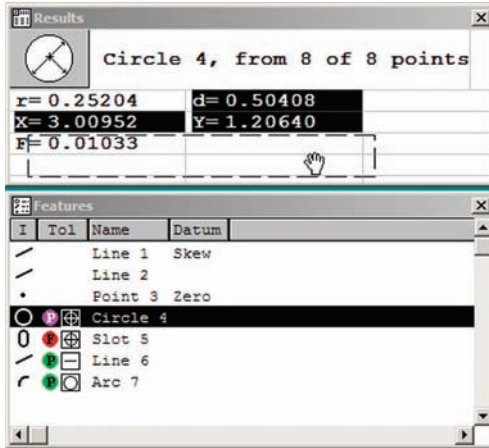

Select a feature, click and drag data fields...

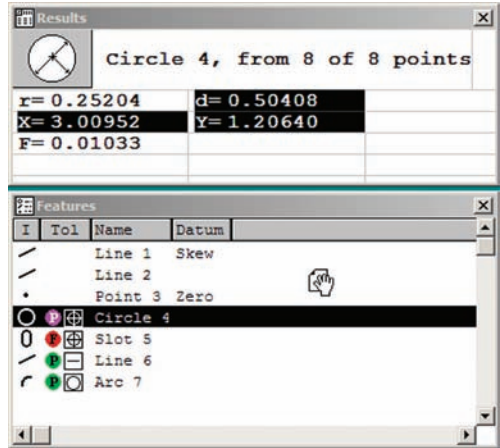

into empty column space of the template

- 2 Click As 1 New Column, give the column a unique name and click OK.

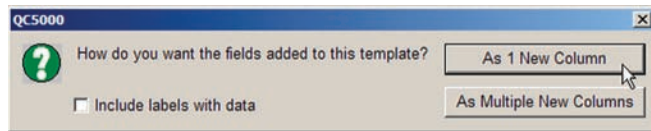

Specify a single new data column...

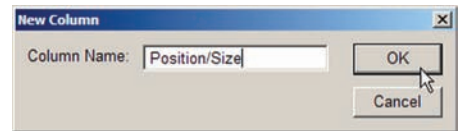

then name the new column

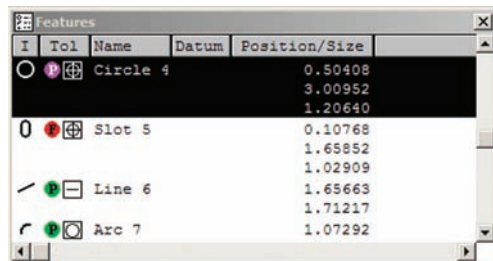

The new column will be added

**Adding multiple data fields as multiple new columns**

To add data fields to a template in multiple new columns:

- 1 Select the data in the Results window and then click and drag the selection to empty column space in the template.

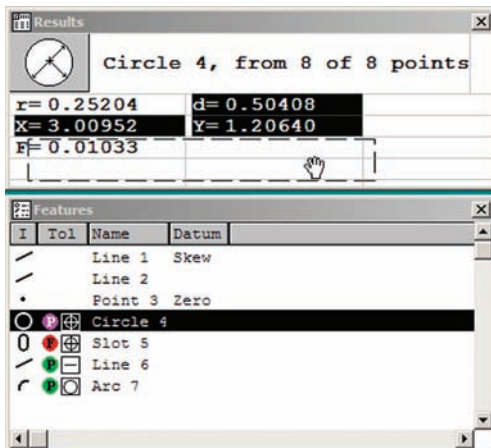

Select a feature, click and drag data fields...

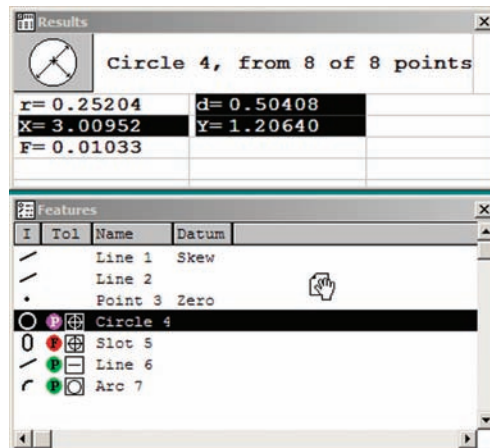

into empty column space of the template

- 2 Click As Multiple New Columns.

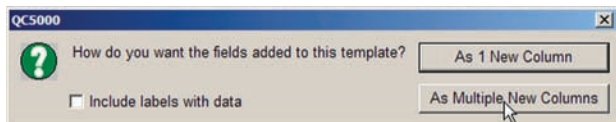

Specify multiple new data columns...

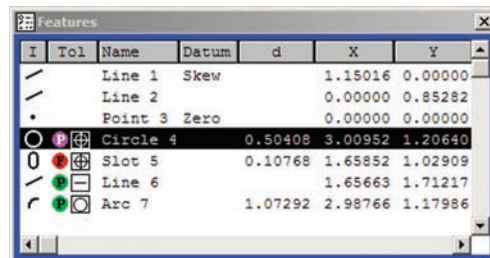

The new columns will be added using names from the Results window

### Appending data fields to an existing column

To add data fields to a template in multiple new columns:

- 1 Select the data in the Results window and then click and drag the selection to empty column space in the template.

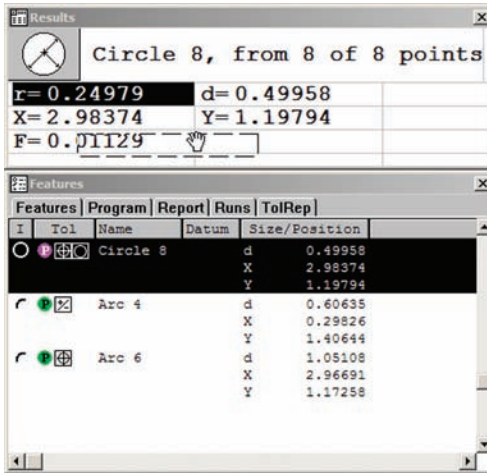

Select a feature, click and drag data fields...

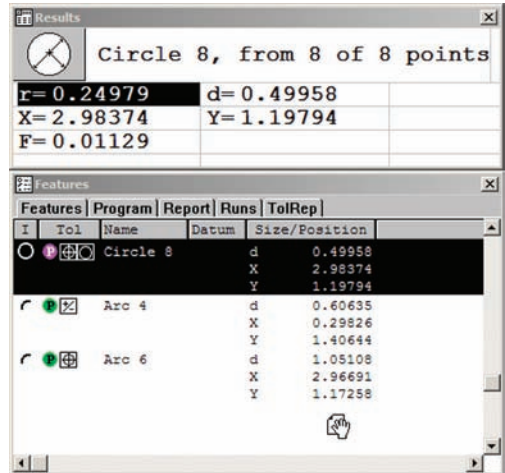

into an existing column space of the template

- 2 Click Appended to this Column.

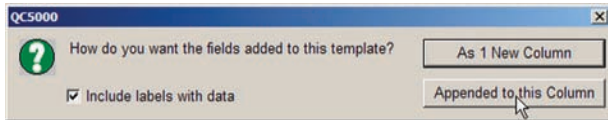

Also check the Include Labels with Data box if you wish to have individual data labels displayed.

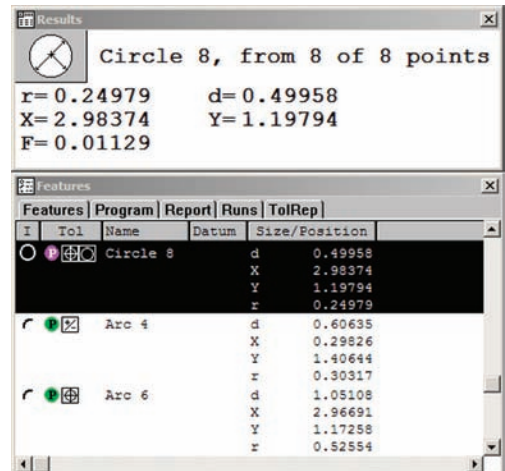

## Deleting data

Data can be deleted from templates by selecting and deleting rows and columns. Deleting a row deletes the feature data contained within the row. Deleting a column deletes the feature data contained within the column and eliminates the future display of the deleted column's data type. In general, data are deleted because columns were added earlier and are no longer required, or because the user wishes to clear the contents of the runs database.



### CAUTION

**Delete Runs data with care, deleted data cannot be restored.**



### NOTE

**Deleting columns from templates permanently changes the type of data that template can display. If a column is mistakenly deleted from a template, a new template can be generated to take its place containing the default columns, as described earlier in this chapter.**

## Deleting rows

To delete rows of data from a template, select the rows, right-click the selected rows and then click Delete Selection. You will be asked to confirm your intention to delete the selection. Click Yes to delete the selection.

Rows can also be deleted by selecting them and pressing the computer keyboard's Delete key.

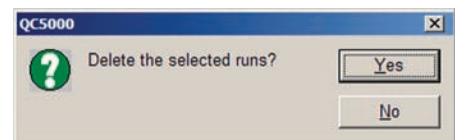
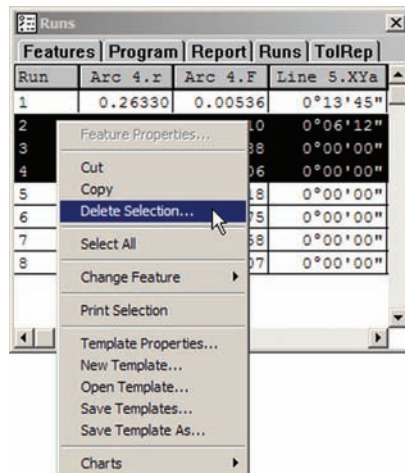

**Select and right-click the rows, click Delete Selection and then click Yes to confirm**

## Deleting columns

To delete columns of data from a template:

1 Right-click the title of the left most column you wish to delete and then click Delete Column. You will be asked how many columns you wish to delete. In this example, four columns that were temporarily used to display position, size and form data will now be deleted from the Features template

2 Enter the number of columns you wish to delete and click OK. The columns will be deleted starting with the one that was selected and extending to the right.

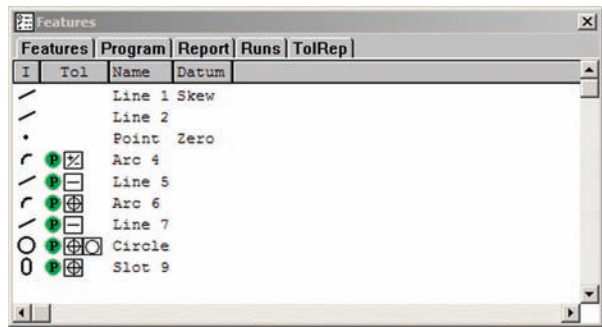
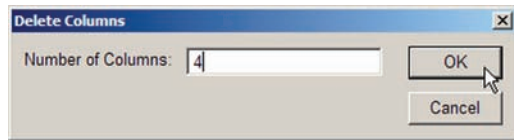
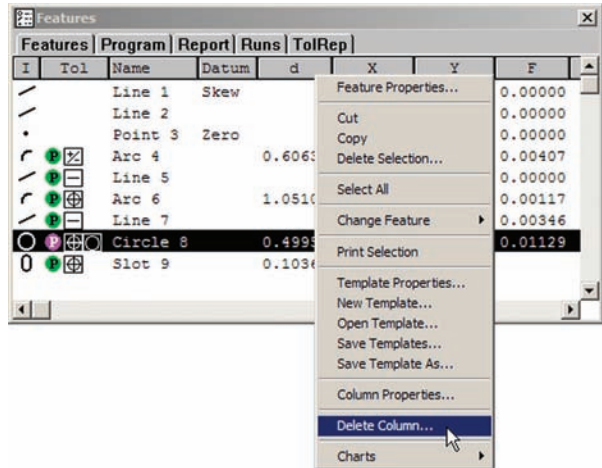

## Sorting data within a column

Data within a template column can be sorted in order of ID list, from the lowest to the highest value or from the highest value to the lowest value. Repeatedly clicking a column title cycles the sort order as show in this diagram.

Run	Arc 4.r
1	0.26330
2	0.28526
3	0.30286
4	0.31812
5	0.34902
6	0.30704
7	0.34345
8	0.30317
9	0.31644

*ID order*

Run	Arc 4.r
1	0.26330
2	0.28526
3	0.30286
8	0.30317
6	0.30704
9	0.31644
4	0.31812
7	0.34345
5	0.34902

*Low to high value*

Run	Arc 4.r
5	0.34902
7	0.34345
4	0.31812
9	0.31644
6	0.30704
8	0.30317
3	0.30286
2	0.28526
1	0.26330

*High to low value*

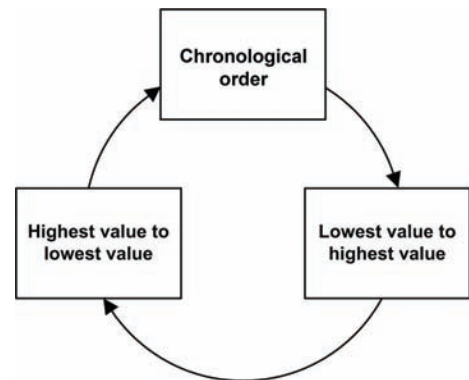

## Aligning column titles and data

Data columns can be formatted to align the column title and data. To format alignment, right-click a column title, click Column Properties and then align the title or data using the tools provided in the Column Properties dialog box.

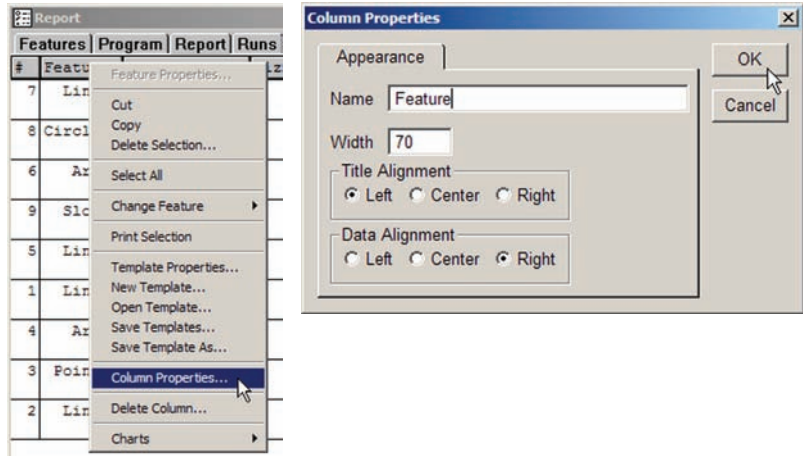

## Changing the order of columns

The order of columns can be changed by moving individual columns left or right. Columns are moved by clicking and dragging the column title to the title to the immediate right of the  insertion point.

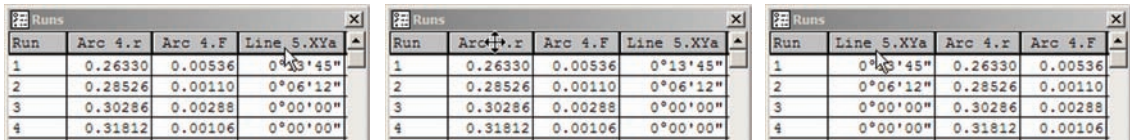

The Line 5.XYa column title is clicked and dragged to the left of the Arc 4.r column

## Displaying horizontal and vertical grid lines

The boundaries of template rows and columns can be emphasized by displaying a grid of horizontal and vertical lines to divide data into cells. To show lines on a template:

1 Right-click the desired template titlebar and then click Template Properties to display the Template Properties dialog box.

2 Check the Display Horizontal and Vertical lines box to display grid lines, and then click OK. Click the Set Line Color to select a line color.

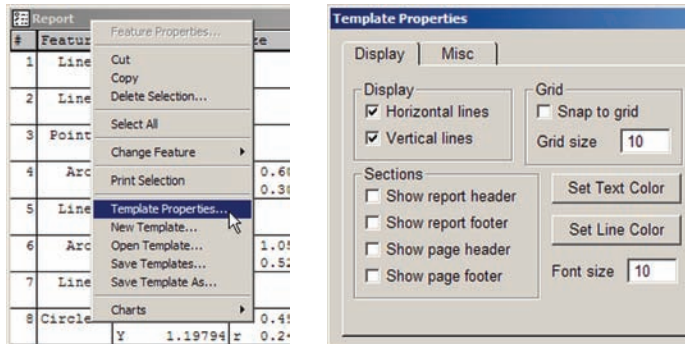

Right-click the titlebar, then click Display Horizontal and Vertical lines



## Headers and footers

Headers and footers are available for all templates and can be shown with text and graphics to provide additional information and enhance the appearance of reports. They can be shown for a report and for the individual pages of a report.

The Report template and all Tolerance templates include default report headers formatted to fill most requirements, other template report headers are empty. Report footers, page headers, and page footers are empty. Empty headers and footers can easily be edited to include text and graphics, include automatic text entry, prompt the user for text and provide speech to text outputs of measurement results.

## Showing headers and footers

The following process is identical for showing all headers and footers. To show a header or footer:

- 1 Right-click the desired template titlebar and then click Template Properties to display the Template Properties dialog box.
- 2 Check the desired Show Header or Show Footer box to show report or page headers and footers, and then click OK.

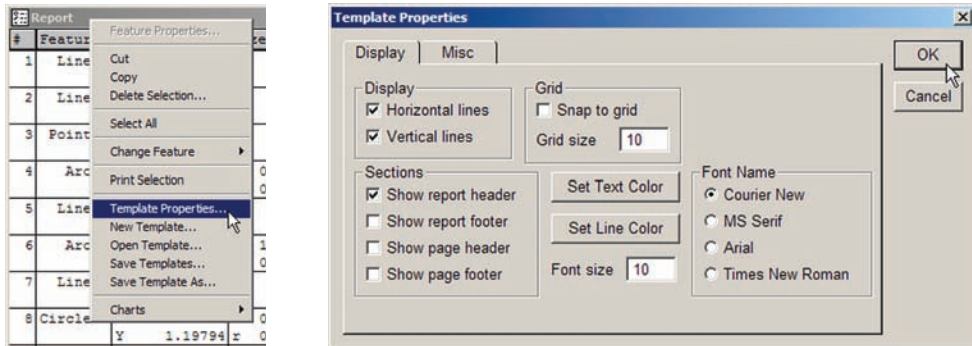

*Right-click the template titlebar...*

*and then check the desired Show header or Show footer box*

#	Feature	Position/Dim.	Size	Orientation	Form/Dim.	Special
1	Line 1	X 1.12671 Y 0.00000		XY< 0°00'00"	F 0.00000	
2	Line 2	X 0.00000 Y 0.89036		XY< 90°00'00"	F 0.00000	
3	Point 3	X 0.00000 Y 0.00000			F 0.00000	

*Default Report template header*

## Editing headers and footers

Headers and footers can be edited to add, delete or format text and graphics, include automatic text entry, prompt the user for text and provide speech to text outputs of measurement results. Completed templates can also be locked to prevent further editing.

### Adding text

Text is added in text frames that can be modified to change content, position and text formatting. To add text, right-click inside a header or footer and then click Add Text. The text frame will be added, and can be repositioned by clicking and dragging it to a new location.

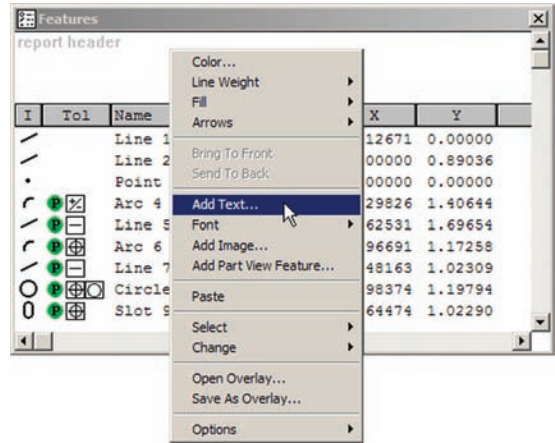
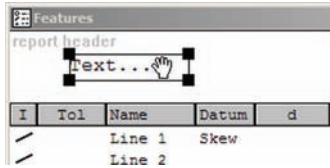

### Editing text

Each text frame of a header or footer can be edited individually. To edit a text frame, click on the text to highlight it, press the computer's backspace key to delete text and then enter new text from the keyboard.



The text frame size can be increased to add more text by clicking and dragging a corner.

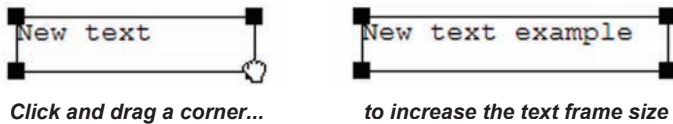

## Formatting text

Text font, style, size and color can be formatted.

### Font

Text font is selected for the entire template from the Template Properties dialog box. To select the font:

- 1 Right-click the template titlebar and then click Template Properties to display the Template Properties dialog box.
- 2 Click the desired Font Name and then click OK.

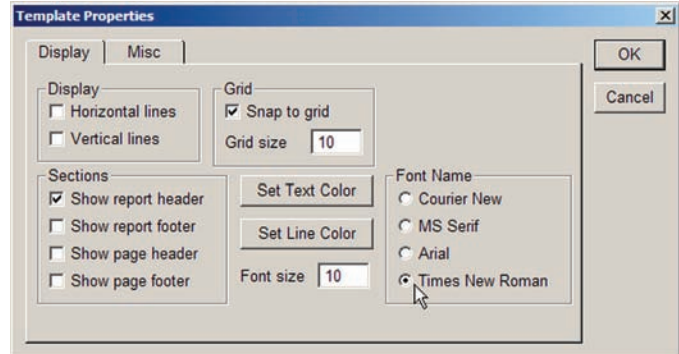

### Style and size

The style and size of text can be selected for individual text frames. To select the style and size of a text frame, right-click the text frame, click Font and then click the desired style or size.

### Color

The color of text can be selected for individual text frames or for the entire template.

To select the color for an individual text frame:

- 1 Right-click the text frame then click Color. The Color pallet will be displayed.
- 2 Select the desired color and click OK.

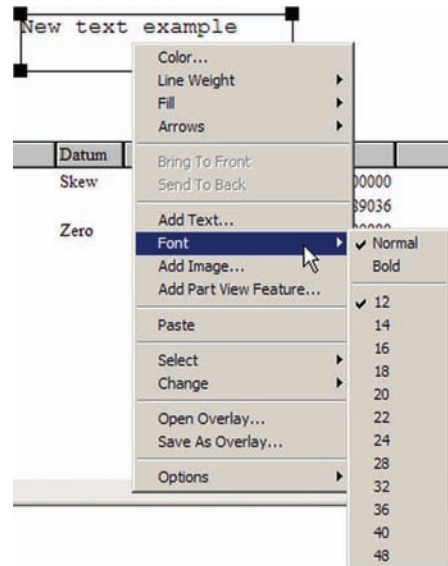

To select the color for the entire template:

1 Right-click the template titlebar and then click Template Properties to display the Template Properties dialog box, then click the Set Text Color button. The Color pallet will be displayed.

2 Select the desired color and click OK.

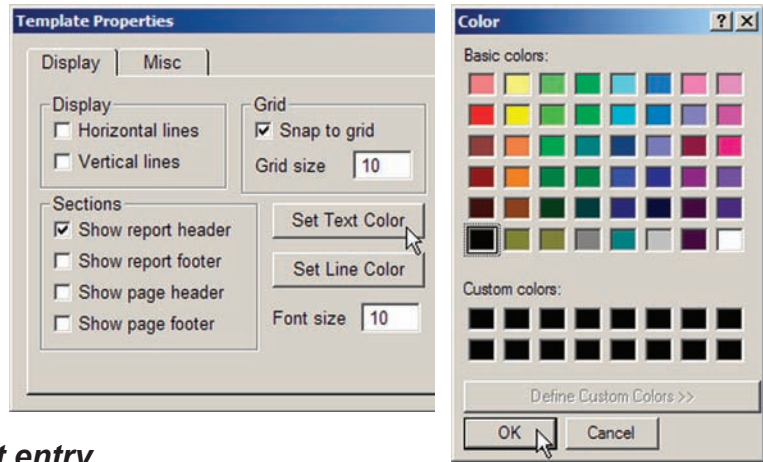

### Including automatic text entry

The system can automatically provide text for printed fields based on information from logins, system time and date and other sources. Information will be inserted into printed report headers where the auto-entry codes are located. The auto-entry codes are shown below. All codes must be lower case.

#### Information auto-entry code

- User name <u>
- Part name <n>
- Time <t>
- Date <d>
- Total number pages <x>
- Current page <p>

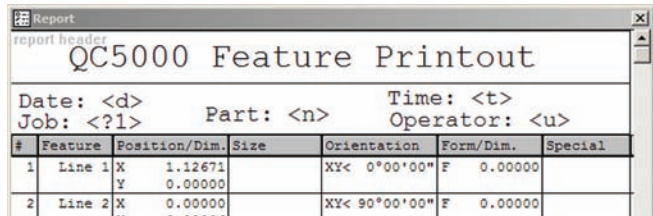

Example of auto-entry code use in a report header

### Prompting the user for alphanumeric information

The system will prompt the user for alphanumeric information for printed reports when the prompt entry code is encountered on a header or footer. The syntax of the prompt entry code is:

<?#>

Where # is the prompt number in a sequence of prompts.

In this example, the system will prompt the user for a part ID, an operator name, and a shift work center number in a single prompt dialog box.

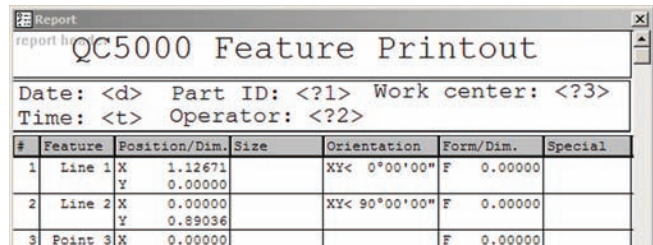

## Deleting text

Each text frame of a header or footer can be deleted individually. To delete a text frame, click on the text to highlight it, press the computer's delete key to delete the text.

## Enabling text to speech output

Measurement results can be spoken by the system's Windows speech to text function as tests are conducted. This is useful when performing manual tests or performing setup tasks because it allows the operator to focus on part measurements without needing to watch the computer screen. To enable text to speech outputs:

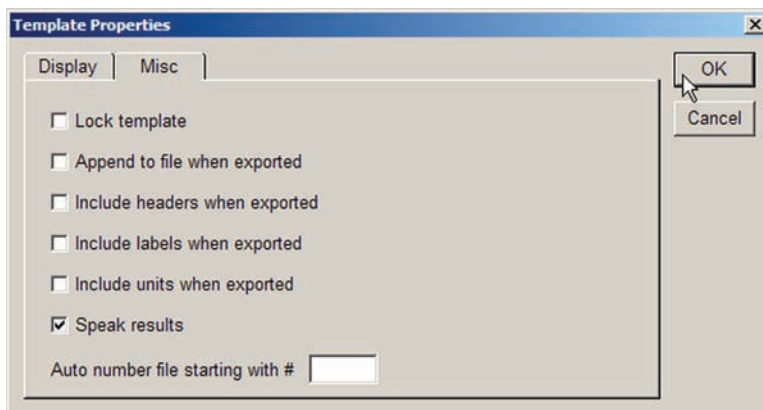

- 1 Right-click the template titlebar and then click Template Properties to display the Template Properties dialog box.
- 2 Click the Misc tab, check the Speak Results box and then click OK.

## Adding graphics from files

Bitmapped (BMP) graphics files can be added to headers and footers to provide additional information or enhance the appearance of reports. To add a BMP graphic from a file:

- 1 Right-click inside the report header and click Add Image. The Add Image file dialog box will be displayed.

It might be necessary to increase the available space inside the header to accommodate the new graphic image. Simply click and drag boundary lines to increase the header size.

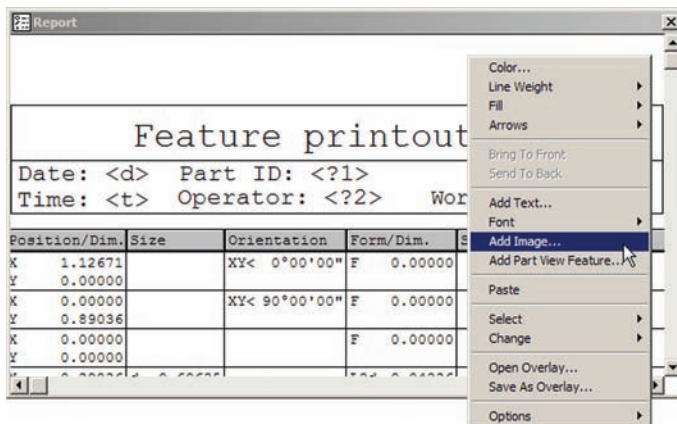

**Right-click in the header space then click Add Image**

2 Select the desired BMP image and click Open. The image will appear inside the header space.

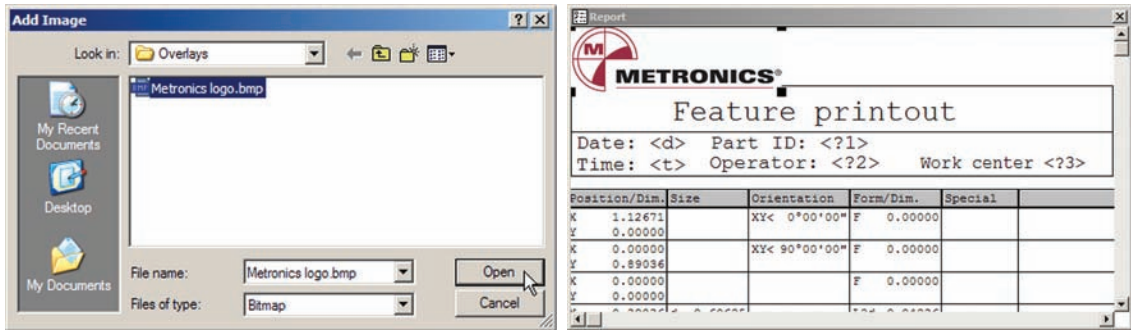

Select the graph BMP file and click Open...

to add the graphic image to the header space

3 Change the size of the graphic image if necessary by clicking and dragging a corner.

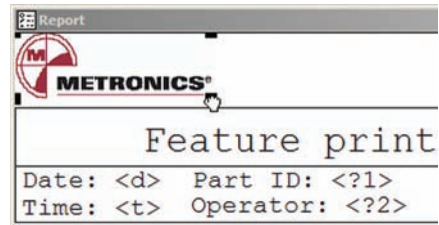

Click and drag a corner to change size

4 Change the location of the graphic image if necessary by clicking and dragging it.

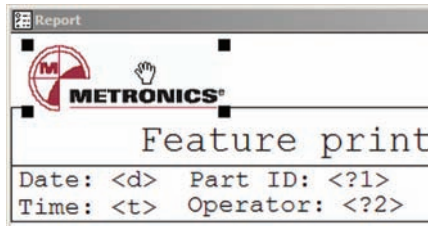

Click and drag to change location



**NOTE**

Graphic images must be color bitmaps (BMP). Black and white bitmaps can easily be opened and saved as color bitmaps using the paint program provided as part of the Windows collection of accessories.

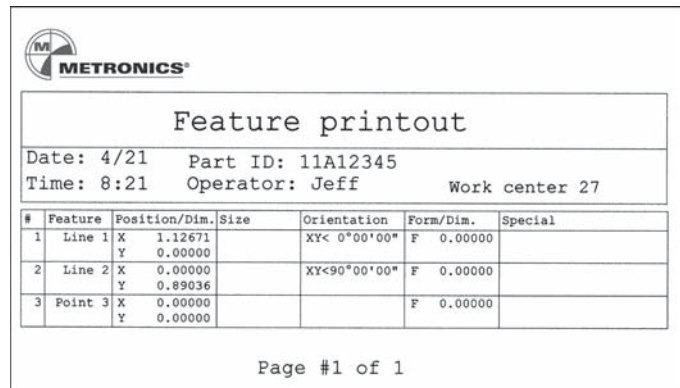

Example of a printed report with a graphic image

## Drawing graphics

Graphic images can be added to headers and footers using the drawing tools provided in the Header/Footer on screen menu. Graphics that can be included are:

- Lines
- Squares
- Rectangles
- Ellipses
- Circles

Closed figures can be filled. The colors of lines and fills can be specified by the user. Lines can be drawn at one of three thicknesses, at any angle and can include arrows.

### Lines

To draw a line, click and drag the mouse within the header or footer space. The cursor will change to a cross when clicked.



When the mouse button is released, the line will appear between the start and stop points, and will be straightened.



The angle of a line can be changed by clicking and dragging an end point.



The location of a line can be changed by clicking and dragging the line.



The color of a line can be changed by right-clicking the line, clicking Color, selecting the desired color from the color pallet and clicking OK.

The width of a line can be changed by right-clicking the line, clicking Line Width, selecting the desired width and clicking OK, as shown below.

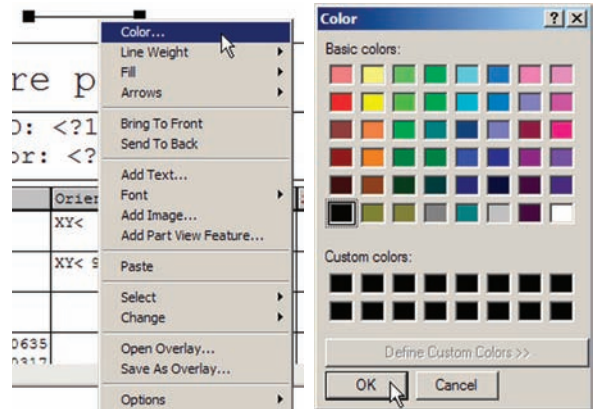
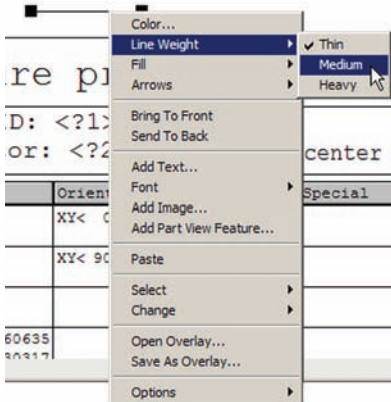

Arrow heads can be added to lines by right-clicking the line, clicking Arrows and clicking the desired arrow function.



Example of a medium width black line with an arrow head

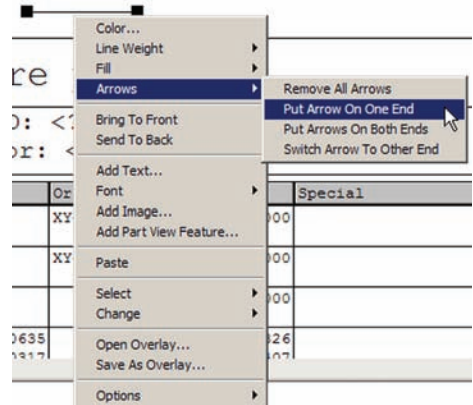

**Square and rectangular shapes**

To draw a square or rectangle, click and drag the mouse within the header or footer space in the general shape of a square or rectangle. The cursor will change to a cross when clicked. When the mouse button is released, the square or rectangle will appear.

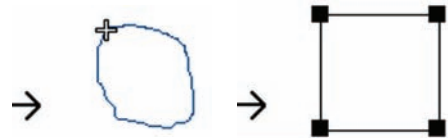

The size can be changed by clicking and dragging a corner.

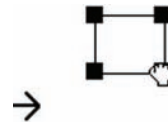

The location of a shape can be changed by clicking and dragging it.

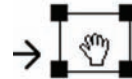

The size and shape can be changed by clicking and dragging a corner.

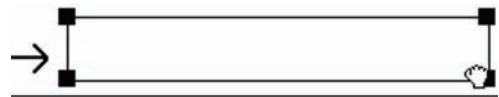

The color can be changed by right-clicking the shape, clicking Color, selecting the desired color from the color pallet and clicking OK, as described for lines on the previous page.

A shape can be filled by right-clicking the shape, clicking Fill and selecting a fill option.

The width of the shape's lines can be changed by right-clicking the shape, clicking Line Width, selecting the desired width and clicking OK, as described for lines on the previous page.



Example of a rectangle used as a signature block



### Elliptical and circular shapes

To draw an ellipse or circle, click and drag the mouse within the header or footer space in the general shape of a square or rectangle. The cursor will change to a cross when clicked. When the mouse button is released, the square or rectangle will appear. →

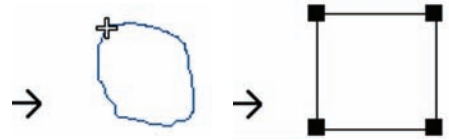

Right-click the shape, click Change and then click Ellipse. The shape will be converted to an ellipse.

The size and shape can be changed by clicking and dragging a corner.

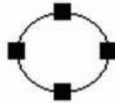

The color can be changed by right-clicking the shape, clicking Color, selecting the desired color from the color pallet and clicking OK, as described for lines on an earlier page.

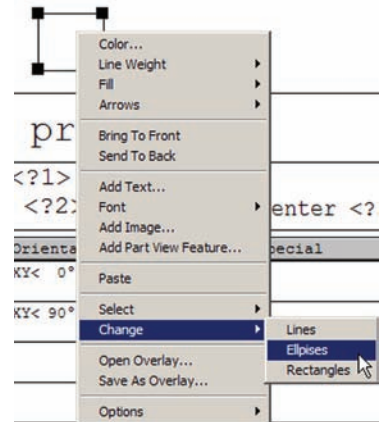
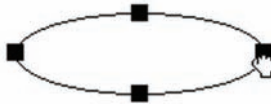

A shape can be filled by right-clicking the shape, clicking Fill and selecting a fill option.

The width of the shape's lines can be changed by right-clicking the shape, clicking Line Width, selecting the desired width and clicking OK, as described for lines on an earlier page.

# Printing reports

A reports can be printed from any template. However, the Report and Tolerance templates are intended for printed reports and include headers describing the job, user and other items typically required for printed reports.

The process of printing a report is diagrammed here.

This example shown below will print the tolerance results for three circles measured on the QC Quickie slide.

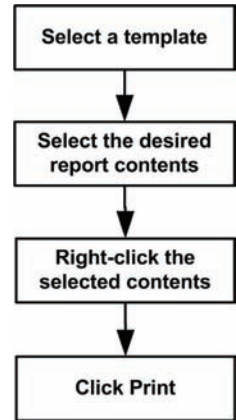

Select the TolRep template as the active template, select the desired report contents (in this case the tolerance data for the three holes), right-click the selection and click Print. The report will be printed to the system's active printer.

| T      | Name | Actual/APD | Nom/Zone | Dev/TPA | Min | Max/EPD |
|--------|------|------------|----------|---------|-----|---------|
| Line 1 | X    | 0.0000     |          |         |     |         |
|        | Y    | 0.0000     |          |         |     |         |
|        | Z    | 0.0000     |          |         |     |         |
|        | a    | 0°00'00"   |          |         |     |         |

Select the active template...

| T | Name      | Actual/APD                                      | Nom/Zone | Dev/TPA | Min | Max/EPD |
|---|-----------|---|----------|---------|-----|---------|
|   | Arc 11    | X -22.9375<br>Y 6.5277<br>r 6.5229<br>f 0.0219  |          |         |     |         |
| P | Circle 12 | X 26.4979<br>Y 20.4329<br>d 6.1567<br>f 0.0163  | 0.0250   |         |     |         |
| P | Circle 13 | X 31.5952<br>Y 35.6740<br>d 4.5804<br>f 0.0110  | 0.0250   |         |     |         |
| P | Circle 14 | X 46.8369<br>Y 30.5820<br>d 12.5451<br>f 0.0408 | 0.0250   |         |     |         |

select the desired report selection and click Print Selection

contents, right-click the

## Exporting data

Data can be exported from any template in a variety of file formats. However, data is generally exported from the Runs template to other applications such as Microsoft Excel. Data is sometimes also exported from the Features template. In most cases the Report and Tolerance templates are printed, but they can be exported as well.

The process of exporting data is diagrammed here. To export data from the Runs template:

1 Select the Runs template as the active template and select the data to be exported.

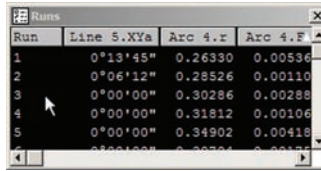

2 Right-click the data and click Template Properties, click the Misc tab, check the desired export options and then click OK..

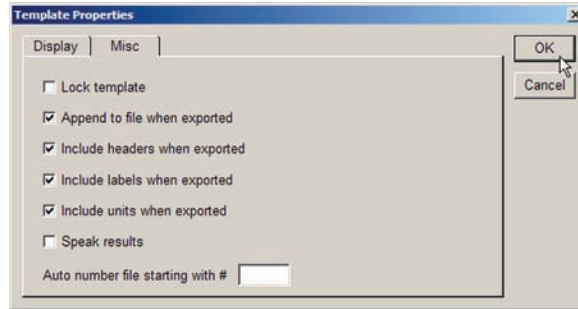

3 Click File/Export, enter the desired export file name into the Export dialog box, select the export file type and click Save.

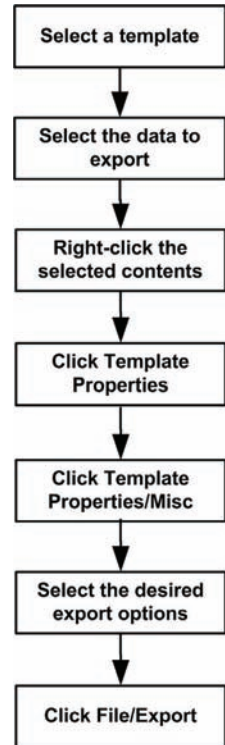
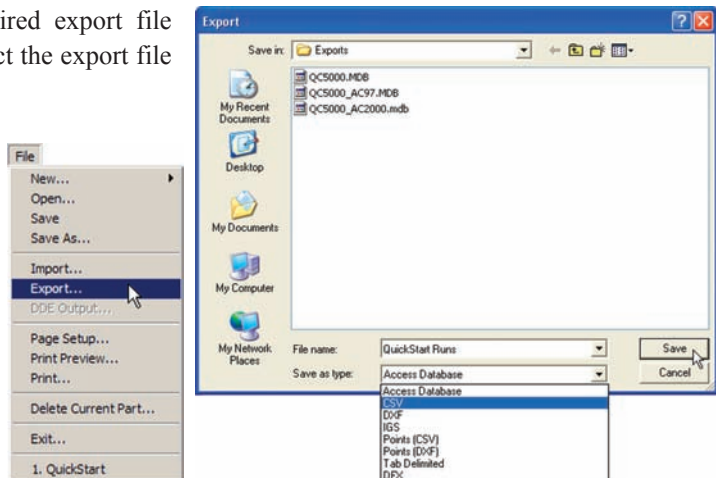

## DDE Output

Data can be output to other applications using the Windows standard DDE protocol from any template. However, data is generally output from the Runs template to applications such as Microsoft Excel. Data is sometimes also output from the Features template. In most cases the Report and Tolerance templates are printed, but they can be output as well.

The DDE output process is diagrammed here. In this example, data will be output from the Features template using the DDE protocol:

1 Select the Features template as the active template and select the data to be output.

2 Click the Results window and highlight the feature measurements to be output.

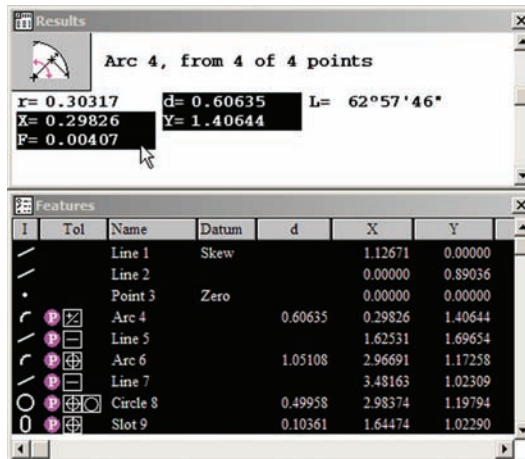

3 Click File/DDE Output, enter the desired DDE output parameters into the DDE Output dialog box and click Save.

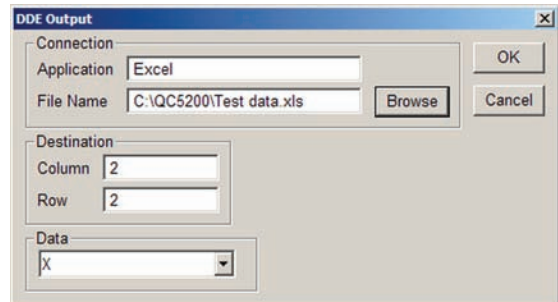

## Output parameters

The following guidelines are provided for DDE output parameters:

### Connection

#### Application

- Must be filled in with an explicit string (e.g. EXCEL)

#### File Name

- Must be filled in with an explicit string (e.g. C:\QC5000\DATA.XLS). It's safer to use full path names here.

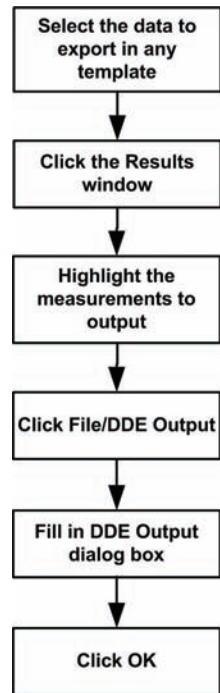

**Destination****Column**

- Number      1, 2, 3...
- Letter      A .. Z
- @Variable    Should resolve to a number or letter (as above)
- Blank        Means “auto append”
- >#          Means “auto append” starting at column #

**Row**

- Number      1, 2, 3, ...
- Letter      A .. Z
- @Variable    Should resolve to a number or letter (as above)
- Blank        Means “auto append”
- >#          Means “auto append” starting at row #

**Data**

One piece of data is sent for each selected feature that has that piece of data.

**General guidelines**

The column and row fields in the DDE Output screen control where data is placed. One piece of data, as determined by the Data drop down list, is sent for each selected feature that has that piece of data.

If both fields have a number in them, then the first piece of data is written at that column/row location in the target application, and each successive piece is added to the same column but in successive rows.

If the column field has a number, and the row field is blank, the system will try to find the first blank cell in that column and put the first piece of data there. Each successive piece is added to the same column but put in successive rows (even if those cells have data in them).

If the row field has a number, and the column field is blank, then the system will try to find the first blank cell in that row and put the first piece of data there. Each successive piece is added to the same row but put in successive columns (even if those cells have data in them).

If the column or row field has a greater than sign (>) followed by a number, the system will act as if the field were blank beginning at the given cell number. So, all cells before that (which might contain other blank cells in some kind of header) are ignored.

Single letters (A..Z) can be used in the Column or Row fields, and get resolved to a number 1..26 before being used. More than one letter (e.g. AC) cannot be used.

Program variables can be used in the Column or Row fields, and at run-time will get resolved to a value which DDE Output will use as if it were entered explicitly by the user.

Before selecting the DDE Output command, you can select fields from the Results Window to automatically choose the data you want to send. This can greatly speed up sending different data coefficients.

# Chapter 8:

# Programming

Sequences of measurement steps can be stored as a program to be executed later. Programs can be run on manual or CNC systems.

When a program is run on a manual system, the series of required probe locations are shown as a blinking green dot that moves over the outline of the part in the Part View window. The user need only probe the locations indicated by the dot to complete a measurement session.

When a program is run on a CNC system with permanent fixturing, the user simply starts the program, then all subsequent measurement activities are completed by the system as the stage is repeatedly positioned and the required points are automatically probed. When temporary fixturing is used, the user performs the initial datum measurements, then the system completes subsequent measurements.

Programs can include any combination of user-defined actions required to:

- Establish measurement references
- Measure, construct or create part features
- Perform tolerance measurements
- Select, and if desired, rename feature data for printed reports and exported files
- Print reports or export reports of measurement results

The following pages contain detailed descriptions of the fundamental QC5200 programming functions. Here's what you'll find in this chapter:

|   |     |
|---|-----|
| Introduction .....  | 249 |
| Creating Programs.....                                    | 250 |
| Creating the new part .....                               | 251 |
| Starting program recording.....                           | 251 |
| Performing a skew and datum.....                          | 251 |
| Choosing a measurement programming method .....           | 251 |
| Adding tolerances .....                                   | 254 |
| Reporting results .....                                   | 254 |
| Optimizing program steps.....                             | 254 |
| Adding special steps to a program.....                    | 255 |
| Finalizing feature properties .....                       | 257 |
| Finalizing program properties.....                        | 258 |
| Stopping program recording .....                          | 261 |
| Saving the part .....                                     | 261 |
| Editing Programs.....                                     | 262 |
| Part fixturing .....                                      | 262 |
| Program runtime environment .....                         | 262 |
| Palletizing multiple parts .....                          | 262 |
| Editing initial program settings.....                     | 265 |
| Editing feature properties.....                           | 269 |
| Adding special and CNC program steps.....                 | 272 |
| Selecting program steps .....                             | 278 |
| Editing individual steps.....                             | 282 |
| Optimizing program steps.....                             | 285 |
| Cutting, copying, pasting and deleting program steps..... | 285 |
| Inserting new program steps .....                         | 286 |
| Debugging programs.....                                   | 287 |



## Introduction

Programs can easily be created by the user to measure features, no previous programming experience is required. Two methods can be used to create programs:

- 1) The user's actions are recorded as features are measured and tolerated
- 2) Part features are imported from a drawing file, the Auto program function creates a program to measure the features and then the user tolerances the features

These two programming methods are shown in a diagram of the programming process in the *Creating programs* section of this chapter. Program steps are stored in the system and displayed in the Program template window. Feature data acquired during program creation or during a program run are displayed in the Features template, the Part View window and the Results window. Tolerance measurement results are shown in the Tolerance template windows and program run data is shown in the Runs template window.

The recommended minimum workspace required for creating programs includes the:

- DRO window
- Results window
- Tolerance template(s)
- Report template
- Features template
- Runs template
- Part View/Live Video windows
- Program template
- Program toolbar

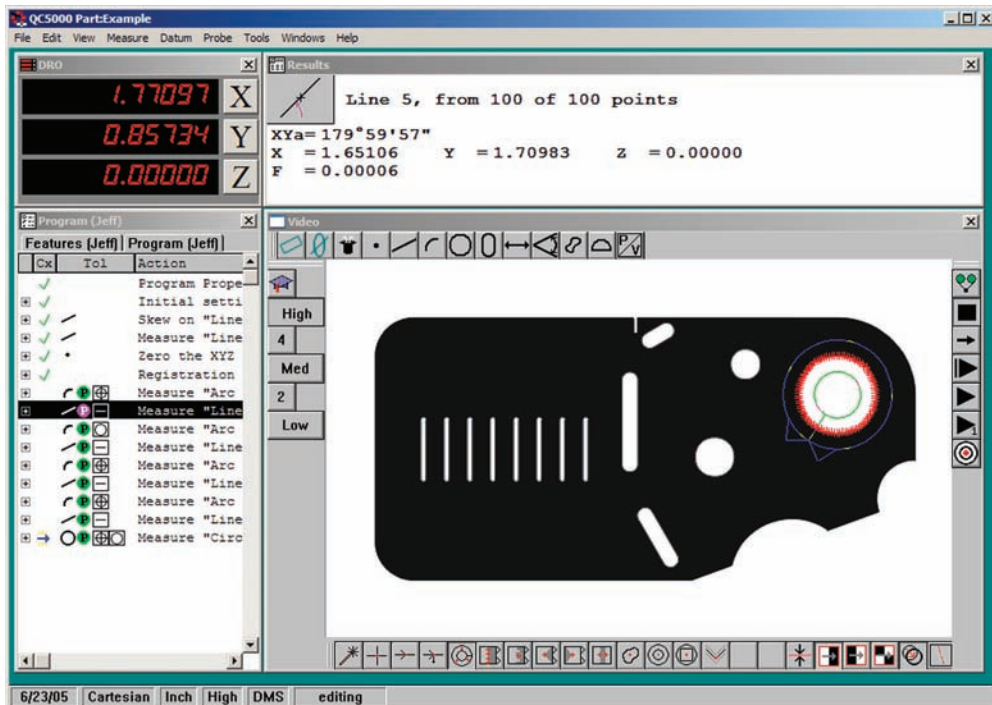

*A typical workspace for programming  
The Part View and Live Video windows are stacked to conserve screen space*

## Creating Programs

The basic programming process shown here is identical for all part types. The details of individual steps are described in the remaining pages of this section.

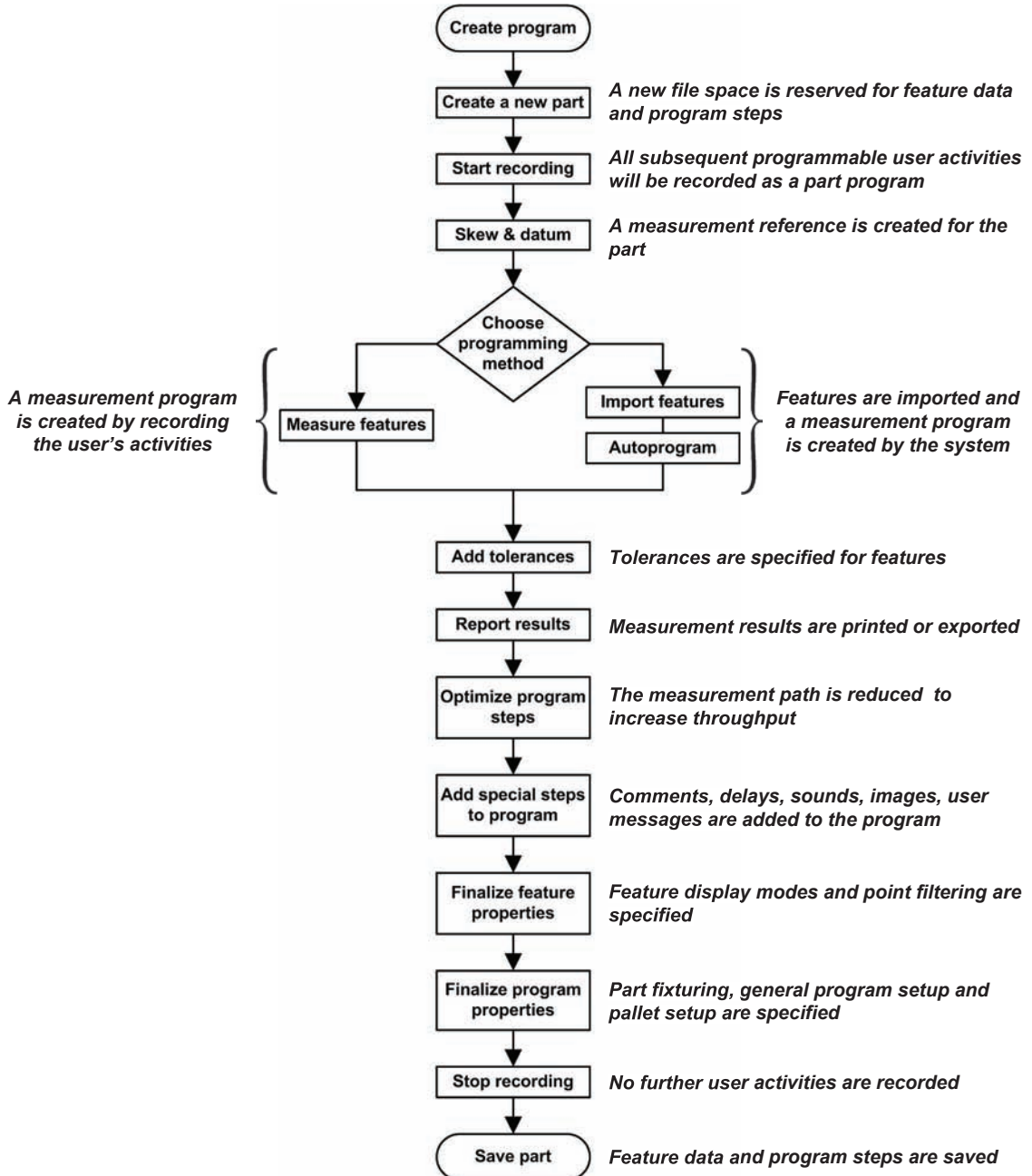

## Creating the new part

The QC5200 part file contains all the part data and any steps recorded during a programming session. A new part should be created prior to recording a new program. Click the File/New/Part menu item to create to create a new part.



## Starting program recording



Click the Tools/Programming/Record menu item or the Record button of the Programming toolbar to start recording measurement activities.

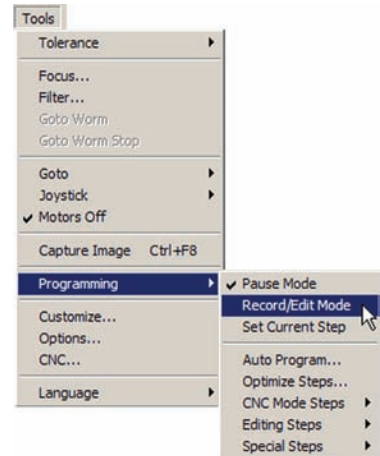

## Performing a skew and datum

The reference for all measurements is obtained by performing the Skew alignment and defining a datum. The establishment of a measurement reference is described earlier in [Chapter 5: Measuring](#). Please refer to Chapter 5 for details.

## Choosing a measurement programming method

Feature measurement steps can be added to the program by recording the user's measurement activities, or by importing features from a drawing file and using the Auto program function have the system create the required measurement steps automatically.

### *Recording the user's measurement activities*

Once the program recording has been started, all probing and measurement steps will be recorded just as the user performs them. The process of probing and measurement is described earlier in [Chapter 5: Measuring](#); the process of assigning tolerances is described earlier in [Chapter 6: Tolerancing](#).

## Importing features

Significant time can be saved by importing features from a drawing file and using the Auto program function to add feature measurement steps to the program. To import features and Auto program measurement steps:

- 1 Click the File/Import menu item. The Import dialog box will be displayed.

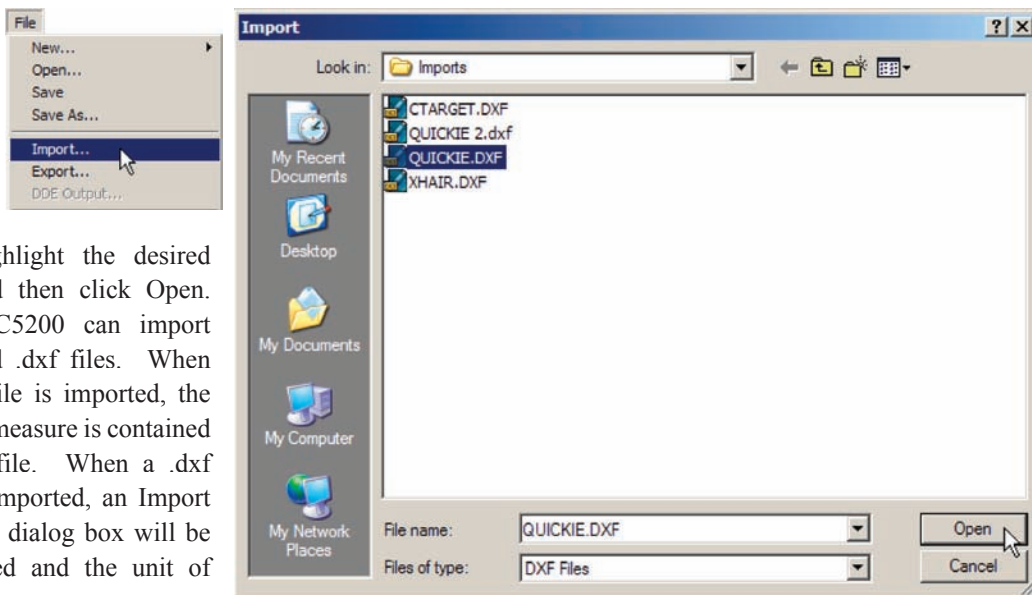

- 2 Highlight the desired file and then click Open. The QC5200 can import .igs and .dxf files. When a .igs file is imported, the unit of measure is contained in the file. When a .dxf file is imported, an Import Options dialog box will be displayed and the unit of

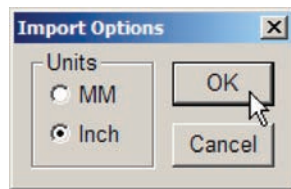

measure must be specified. Click the mm or inch radio button to specify the appropriate unit of measure for the imported features, and then click OK. The features will be imported and shown in the Features template and Part View window.

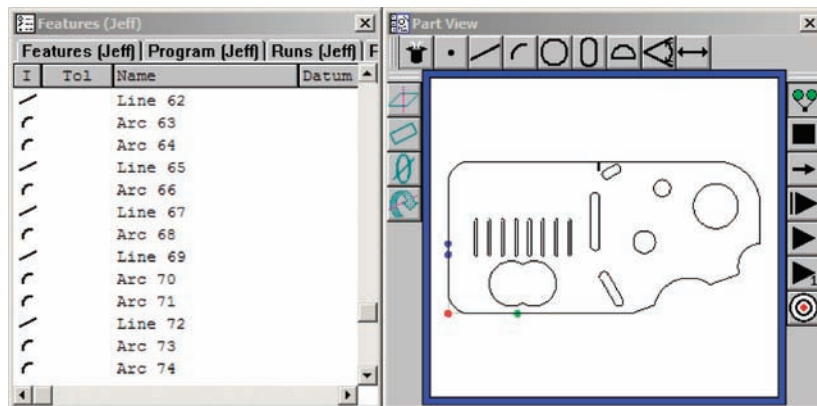

*Imported features are shown in the Features template and Part View window*

### Auto programming measurement steps

The Auto program function can be used to create feature measurement program steps for any features contained in the Features template. The Auto program function will create program steps for features that have been probed or imported. To use the Auto program function to create program steps:

- 1 Highlight the desired features in the Features template.



**NOTE**

**Do not highlight the first few features that were measured when the measurement reference was created.**

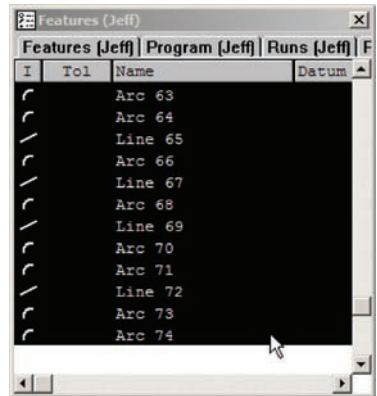

*Features highlighted in the Features template*

- 2 Click the Tools/Programming/Auto program menu item. The Auto programming dialog box will be displayed.

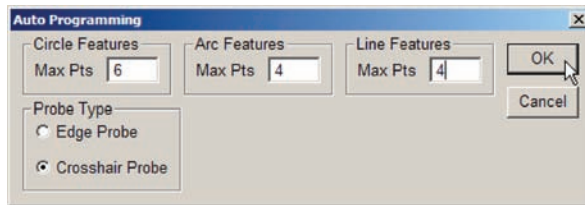
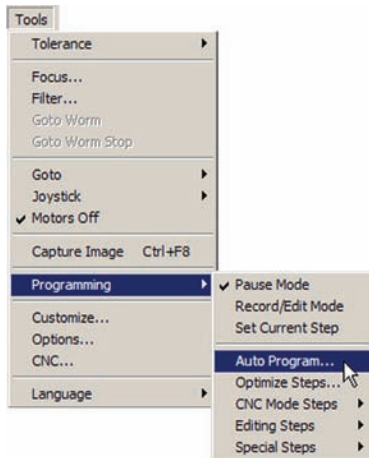

- 3 Enter the desired number of probed points for the circle, arc and line features, and then specify the probe type by clicking a Probe Type radio button. Click OK to create program steps for the highlighted features. The new program steps will be shown in the Program template.

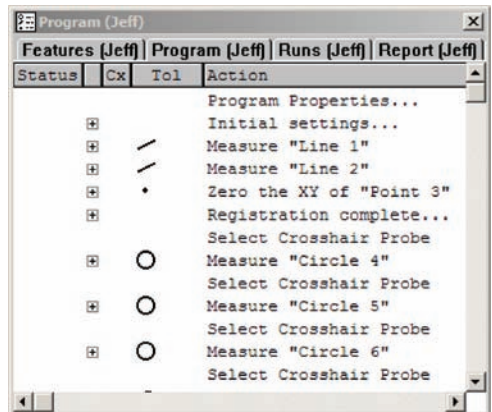

*New program steps for highlighted features*

## Adding tolerances

The process of assigning tolerances to features is described earlier in [Chapter 6: Tolerancing](#). Please refer to chapter 6 for details.

## Reporting results

Typically, measurement results are reported by printing or exporting the measurement and tolerance data. Many report formats can be developed by the user and used to report results.

Reporting activities must be performed in the order shown here. Reports can be printed and exported to other computers as data files. Detailed instructions for all the reporting steps are included in [Chapter 7: Reporting and Templates](#).

## Optimizing program steps

When a program runs, the user is guided (or the CNC stage is driven) along a path that follows the feature shapes as points are probed. This path is either the exact path followed by the user as measurements were recorded or is the path assigned by the system during Auto programming. Often this path is not the most efficient and the throughput can be increased by shortening or optimizing it. The Optimize Steps function attempts to create an efficient path for any collection of program steps highlighted in the Program template. In the example shown here the probing path required to measure 7 features is shortened 26% by optimizing program steps.

To optimize program steps:

- 1 Highlight the program steps that you wish to optimize.



### NOTE

**Do not highlight the first few features that were measured when the measurement reference was created.**

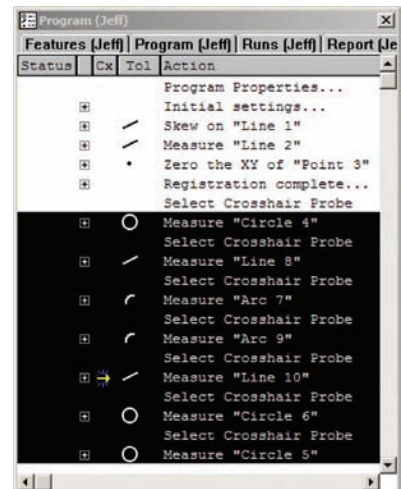
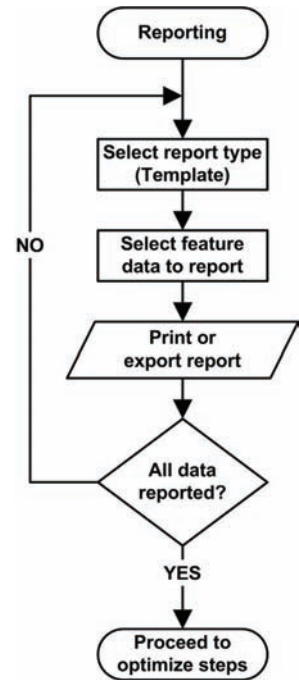

2 Click the Tools/Programming/Optimize Steps menu item. You will be asked to confirm your intention to optimize steps.

When the steps have been optimized, a QC5200 message box will show the level of optimization obtained.

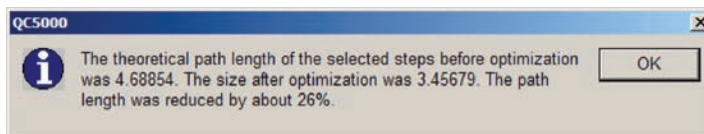

## Adding special steps to a program

Program steps can be added to perform a variety of functions that enhance usability and accommodate special application requirements. These functions include:

- Adding a comment to a program to clarify a step or series of steps
- Adding a program time delay at a specified point during execution
- Playing a user-defined sound at a specified point during execution
- Displaying a user-defined image at a specified point during execution
- Displaying a message to the user at a specified point during execution
- Toggling the maximum program execution speed on or off. When the maximum program execution speed is toggled on, the system commitment to program execution is increased by disabling the detailed display of part view, Results window and template window activities. When the program has finished executing, these displays will be reactivated.



### NOTE

This example shows how to add a special step to a program. More details regarding each of the special steps are contained later in this chapter in the *Editing Programs* section.

To add a special step to the program:

1 Enable the Record Program mode by clicking the Tools/Programming/Record menu item or the Record button of the Programming toolbar.

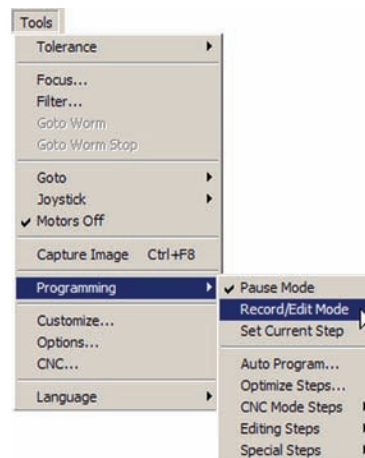

- 2 Display the Program template content and highlight the step preceding the insertion point for the new step, and then click the Tools/Programming/Set Current Step menu item to set the insertion point. An indicator arrow will show the current step.

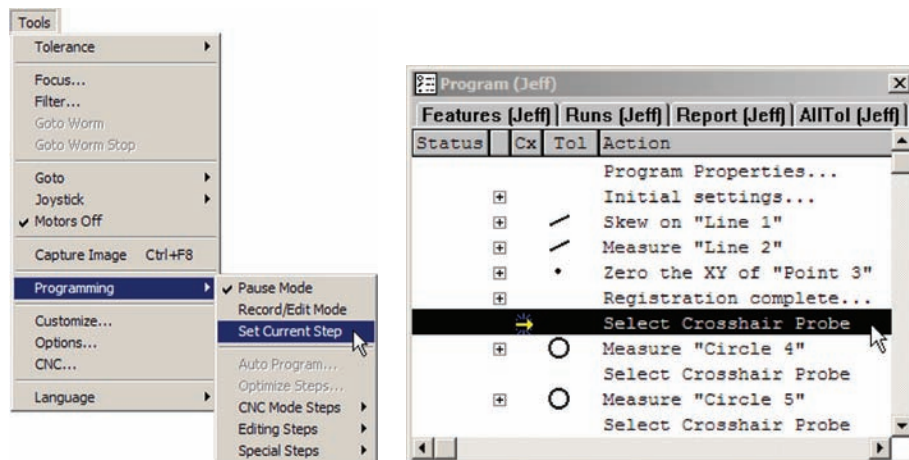

*The current insertion point is set before Measure "Circle 4"*

- 3 Click the Tools/Programming/Special Steps menu item to display the submenu of special steps available, then click the desired special step. This example shows the insertion of a comment in the program prior to measuring circle 4, which is a half inch hole in the part. The method shown in this example is used to insert all special steps. More details regarding special steps are contained later in this chapter in the *Editing Programs* section.

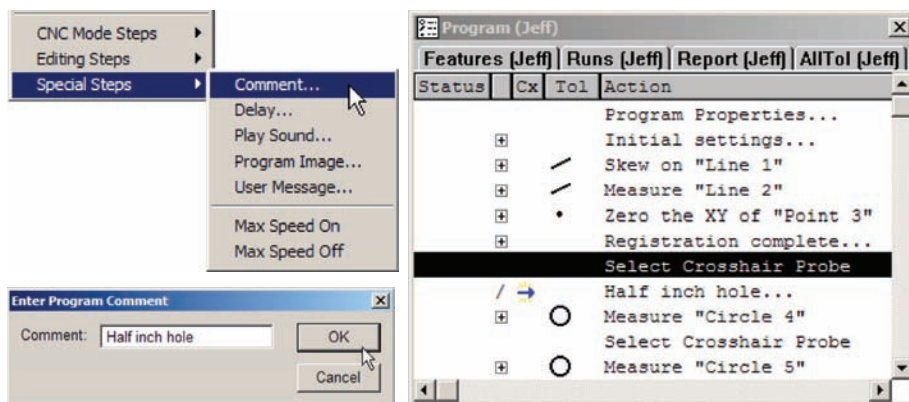

*The comment step is selected, defined by the user and inserted into the program*



## Finalizing feature properties

The default display and point filtration properties of features are determined by settings in the Tools/Options/Measure and Tools/Options/Point Filtration Supervisor Setup screens. However, these default feature properties can be modified for individual features using the Feature Properties menu item of the Features template window. The following feature properties can be changed:

- Feature name
- Feature display mode in the Part View window
- Point filtration for probed points



### NOTE

This example shows how to change a feature name and two display characteristics. More details regarding feature properties are contained later in this chapter in the *Editing Programs* section.

To change a feature's properties:

- 1 Right-click the desired feature in the Feature template window, and then click Feature Properties to display the Feature Properties dialog box.

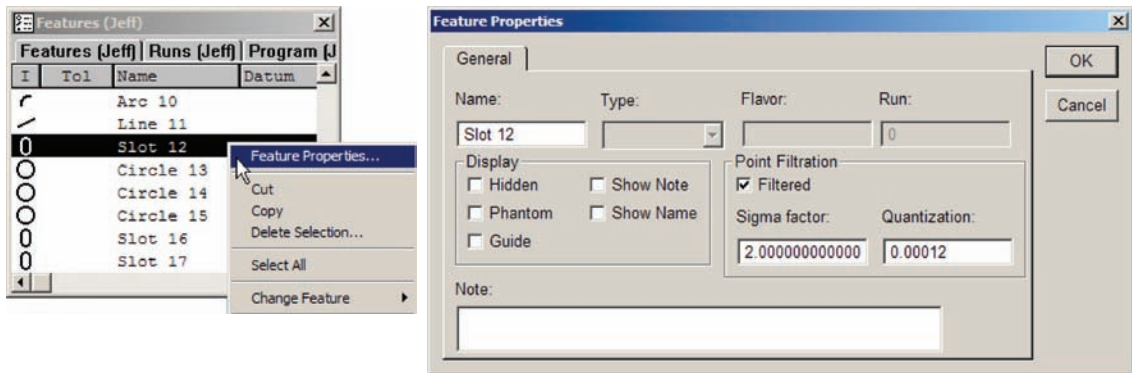

**Right-click a feature, and then click Feature Properties to display the Feature Property dialog box**

- 2 The feature name can be changed to enhance reporting. To change the feature name, highlight the existing name and then enter a new name in its place.



- 3 By default each feature is outlined in the Part View window by a solid black line that turns blue when the feature is selected. Constructed features are shown as dashed lines. No names or special notes are shown. These defaults can be changed by checking boxes in the Display group of the dialog box, and adding text into the Note field.

For example, the name of the long slot and a note can be added to the display of the slot by checking the Show Name and Show Note boxes and entering text into the Note field.

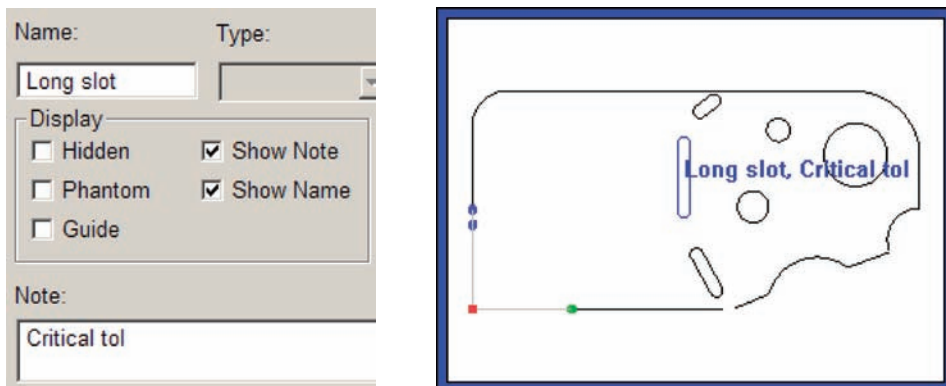

*Checking the Show Name and Show Note boxes and entering text into the Note field changes the display of a slot feature*

## Finalizing program properties

Program properties include settings that must be configured at the time a program is created, and a few that might best be configured as part of the program editing process. Program property setup screens are displayed by double-clicking the first program line (Program properties line) in the Program template window.

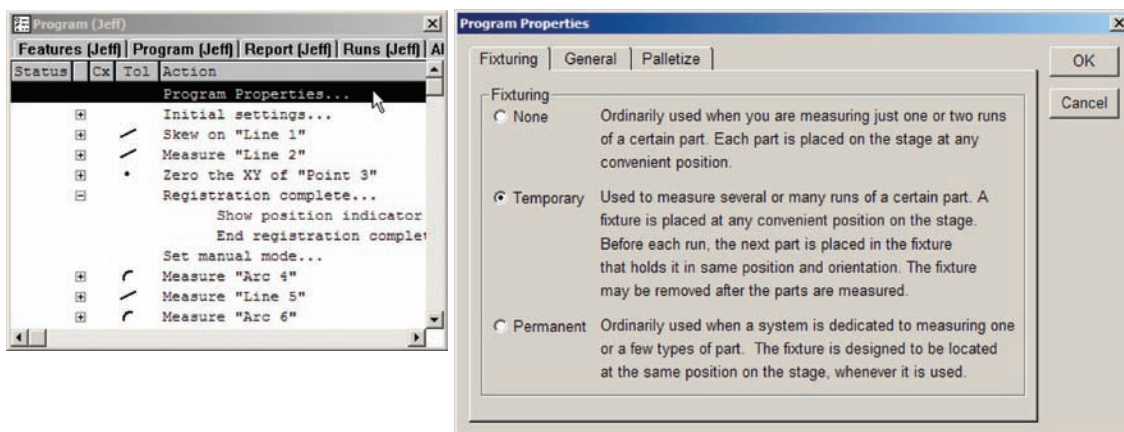

*Double-clicking Program Properties in the Program template displays the Program Properties setup screens*

Program properties setup screens include:

- **Fixturing**  
The selection of part fixturing determines when the user will be expected to measure a reference and datum during program execution.
- **General**  
The General program setup defines the runtime environment for the QC5200 part program
- **Palletize**  
Once a part program is created and its correct operation has been confirmed, it can be configured to measure a matrix of identical parts held in a pallet.

### Specifying part fixturing

When all of the program's measurement and reporting activities have been completed, the part fixturing for CNC systems must be specified to insure that subsequent program runs will include the correct measurement reference and datum.

Three fixturing modes are available:

#### None

No part fixturing is used, a measurement reference and datum must be created by the user for each part prior to measurements.

#### Temporary

Temporary part fixturing is used, a measurement reference and datum must be created for the first part by the user, thereafter the system will perform measurement reference and datum measurements automatically for each part.

#### Permanent

The part fixturing is permanently attached; this is a dedicated fixture. The system retains the measurement reference and datum as part of the program, no user interaction is required to create a measurement reference or datum.

To specify the desired fixturing mode:

- 1 Right-click the Program Properties line in the Program template (first line). The Fixturing setup screen of the Program Properties dialog box will be displayed.
- 2 Click the radio button of the desired part fixturing mode and click OK.

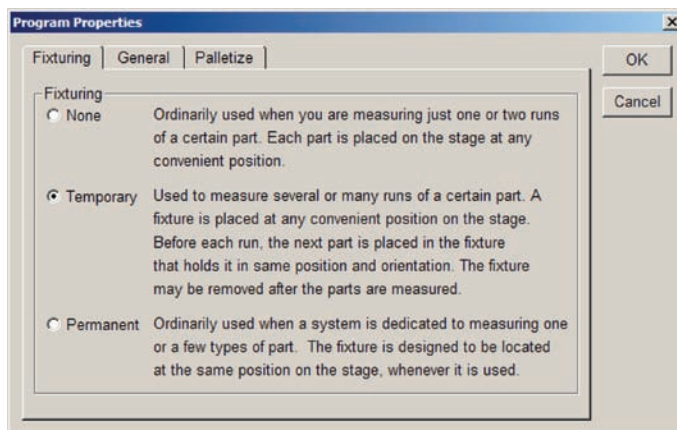

## ***Specifying the program's run time environment***

The run time environment settings for part programs are contained in the Program Properties General setup screen shown on the next page. These settings include:

### **Run program this many times**

A number of program executions can be specified to simplify the process of measuring a series of identical parts. Enter the desired number of sequential program executions into the data field.

### **Use machine reference frame**

Check this box to insure that all datums are deleted prior to executing the program. This is essential when a permanent fixture is used to hold the part because the first CNC moves used to establish a reference frame for the part are performed automatically by the system using the datum that exists when the program execution begins.

### **Empty feature list before running**

Check this box to clear the Feature template at the beginning of each run on a new part. This restricts the display of features to one part when a series of identical parts are being measured and reported by a sequence of program executions.

### **Use probe teach values as recorded**

This box pertains to a probe teach function included in the part program. Check this box to perform one probe teach during the first program recording, and then use the teach values for all subsequent executions in a series. Clear this box to perform a new probe teach at the beginning of each program execution. Including a probe teach function in each program execution is useful when light conditions or part characteristics are variable.

### **Do not report any errors during program execution**

Check this box to suppress error reporting that displays messages and pauses program execution.

### **Prevent program from being modified by anyone but supervisor**

Check this box to restrict program editing to supervisors and other personnel authorized to use the supervisor's password.

### **Close the part when done running**

Check this box to automatically close the part when the program finishes executing. This function is typically used in an environment that restricts the user's activities to loading a part and then running a single automated series of feature measurements.

### **Randomly measure this percent of guide features**

Typically, some features are designated as guide features and are displayed in the Part View window to help users visualize the path but are not measured. However, in applications that include a large number

of features that can be sampled, all features might be designated as guide features and a random percentage are measured. Check this box to measure the desired percentage of guide features.

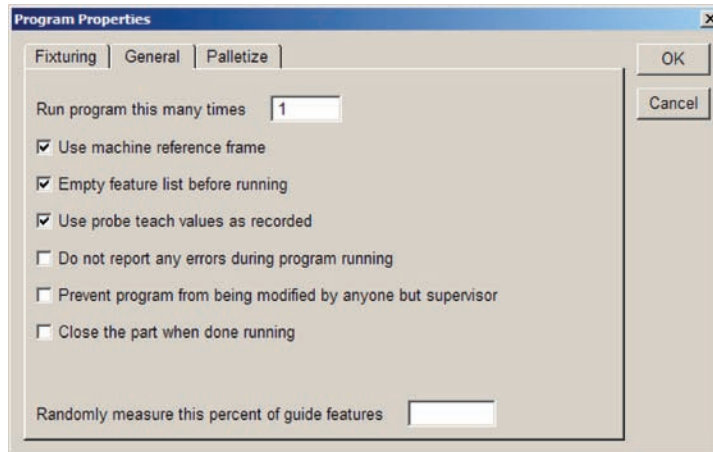

*Check boxes and enter values to specify the QC5200 part program run time environment*

## Stopping program recording

Click the Tools/Programming/Edit mode menu item, the Pause Program button of the Programming toolbar or the Recording indication in the Status bar to stop recording measurement activities.

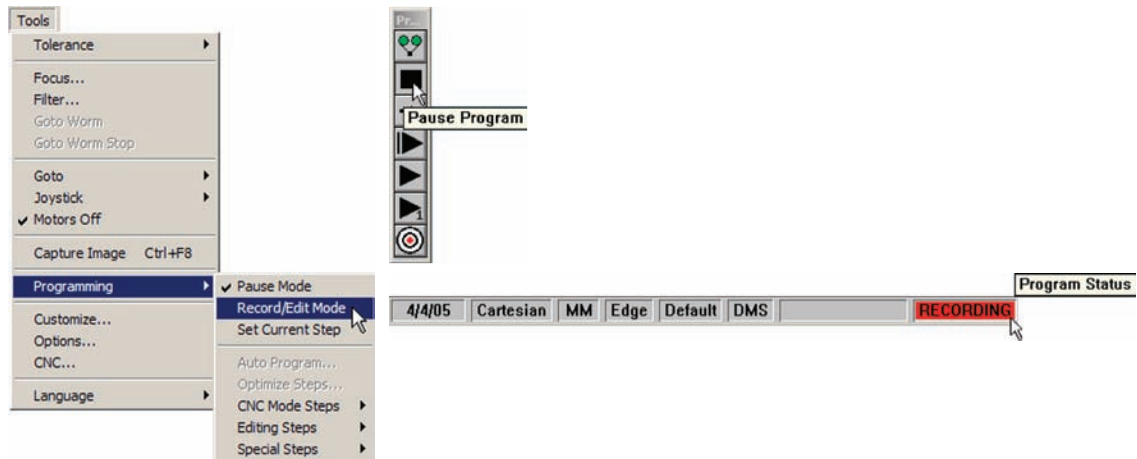

## Saving the part

Click the File/Save menu item to save the part including all feature data and the program. The part data and program will be saved in a part (.5pa) file in the default file location C:\QC5000\parts. The data from program executions will be saved in a runs (.5ru) file at the same default location.

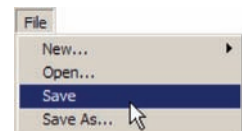

## Editing Programs

Nearly every aspect of an existing QC5200 part program can be edited. Specific items and functions that can be edited include:

- Part fixturing
- Program runtime environment
- Palletizing multiple parts
- Feature properties
- Point filtration
- Initial program settings loaded prior to execution
- Insertion of special steps including comments, delays, sounds, images and messages
- Enabling or disabling the display of run-time graphics
- Optimizing program steps to increase execution speed
- Enabling or disabling full CNC mode
- Enabling or disabling focus lock
- Selecting program steps
- Cutting, copying, pasting, and deleting program steps
- Inserting new program steps

### Part fixturing

The configuration of part fixturing parameters is described earlier in this chapter in the Creating Programs section.

### Program runtime environment

The configuration of program runtime environment parameters is described earlier in this chapter in the Creating Programs section.

### Palletizing multiple parts

A palette is a rectangular arrangement of identical parts organized into a consistent matrix of columns and rows. The X and Y offsets between parts in the matrix must be the same for all parts.

Once a part program is created and tested for a single part, it can be run on each of the identical parts contained in a palette. The QC5200 will begin measuring parts at the lower-left corner of the palette, and will proceed from left to right and from bottom to top.

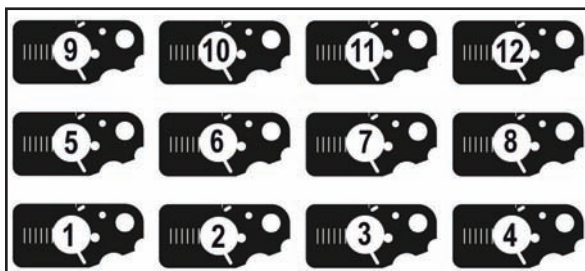

*Parts are measured from left to right and from bottom to top as shown above*

To configure a palette of parts:

- 1 Enable the program record mode by clicking the Tools/Programming/Record menu item or the Record button of the Programming toolbar

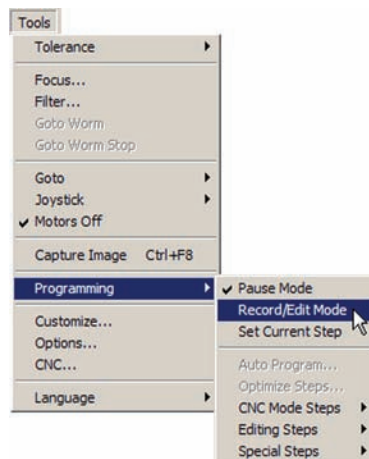

- 2 Double-click the Program Properties line in the Program template to display the Program Properties screens (first-line).

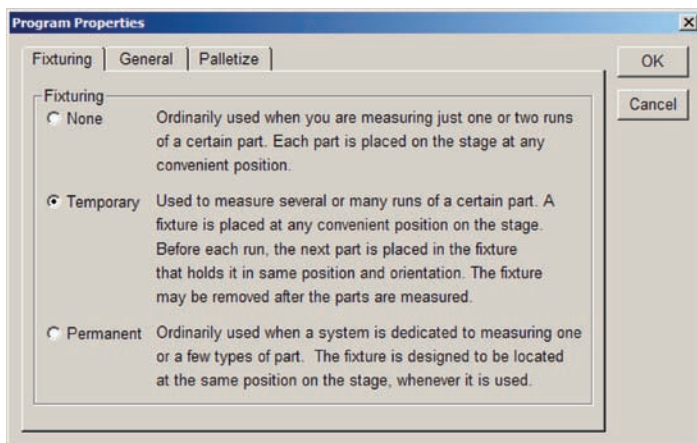
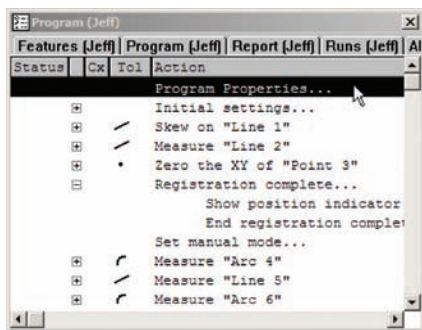

- 3 Click the Palettize tab to display the Palette setup screen.

- 4 Enter the number of palette columns and rows into the fields provided.

- 5 Enter the X and Y offsets between the parts into the fields provided.

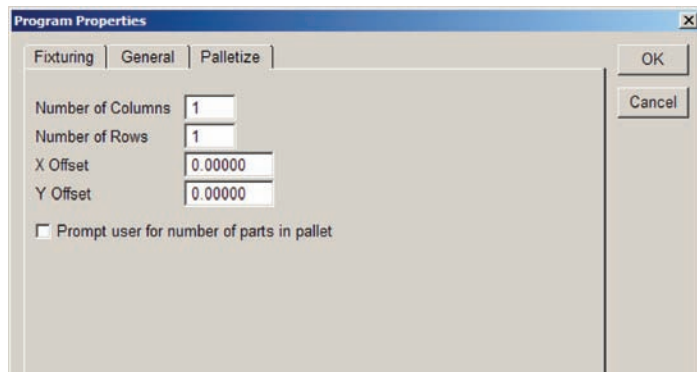

6 When it is known that some pallets will not be full, the program can be configured to prompt the operator at the beginning of each program execution to specify the number of parts contained by the current pallet.

Check the Prompt user... box to specify the number of parts contained in the pallet when the pallet is not full. The Number of Parts dialog box will be displayed.

Enter the number of parts contained in the pallet and click OK.

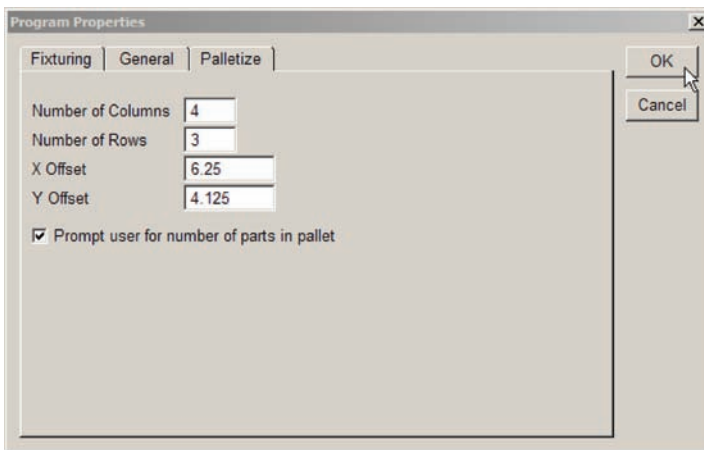

When the program runs, the QC5200 will measure parts until the number of parts specified have been measured.



#### NOTE

**The matrix of parts must be contiguous. Empty locations within the pallet will cause the program execution to halt.**



## Editing initial program settings

Current system configurations are saved as initial settings when the Record function is initiated. The initial program settings will configure many aspects of the program's runtime environment when the program is launched, these include:

- Probe position indicator
- Template state
- Light controls
- Optical magnification
- Probe selection
- High accuracy mode
- Focus lock
- Display units of measure

Click the leading + sign to expand and display the program's initial settings.

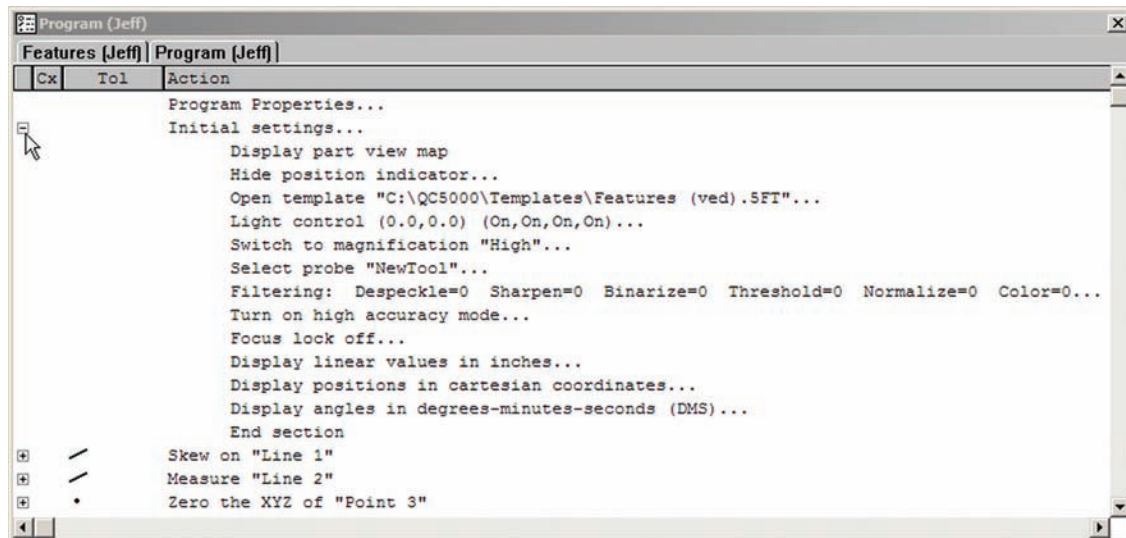
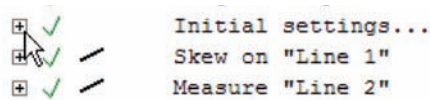

Initial settings line items ending in an ellipsis (...) can be edited by double-clicking the line. Double-clicking a line item either toggles its setting to a new value or displays a dialog box for entering setting information.

### Probe position indicator

The probe indicator shows the probe's current position and is a cross for crosshairs or a circle for edge detectors. The position indicator can be toggled on or off by double-clicking the Hide/Show Position Indicator line.

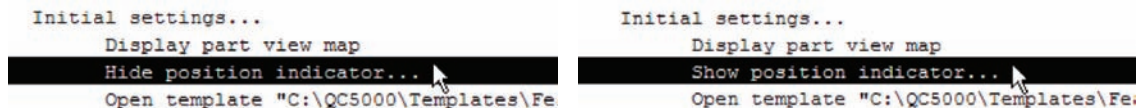

**Double-click the Position Indicator line to toggle between Hide and Show**

The probe position indicator can be useful to operators that are manually probing features. However, it typically serves little purpose when running a CNC program and might best be hidden to conserve computer resources and speed program execution.

### Template state

Templates that are open when a program is recorded will appear in the list of initial settings. Each template can be cycled through 3 states by double-clicking the template line.

- Open Open in the template window
- Close Closed and not displayed
- Select Opened and selected as the current template

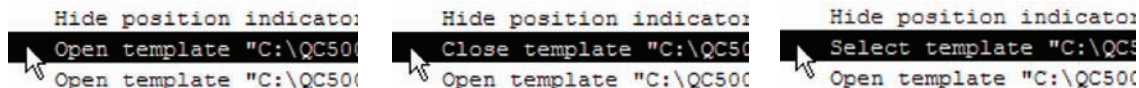

**Double-click a Template line to change its state**

Templates can be closed during program execution to conserve computer resources and speed program execution.



#### CAUTION

The Runs template must be opened to accumulate data in the Runs database.

### Light controls

The part lighting control settings are edited by double-clicking the Light Control line and changing the light control slider values. The new slider values will be displayed in the Light Control line when the editing activities are finished.

```

Open template "C:\QC5000\Templates\Features.5ft"...
editing Light control (78.0,0.0,0.0,0.0,0.0,0.0) (On,On,On,On)...
Switch to magnification "Low"...
```

Double-click the Light Control line to edit light control values...



then change the light control slider values

```

Open template "C:\QC5000\Templates\Features.5ft"...
Light control (78.0, 34.5,0.0,0.0,0.0,0.0) (On,On,On,On)...
Switch to magnification "Low"...
```

the new light control values will be shown when editing is finished

### Optical magnification

Double-click the Switch to magnification line to change the optical magnification. The Edit Magnification dialog box will be displayed. Enter the magnification name into the text field exactly as it is shown in the Probe/Magnification menu.

```

Open template "C:\QC5000\Templates
Light control (780.0,0.0,0.0,0.0,0.0,0.0
Switch to magnification "Low"...
Select probe "Simple"...
Filtering: Despeckle=0 Sharpen=0
```

Double-click the Switch to magnification line...

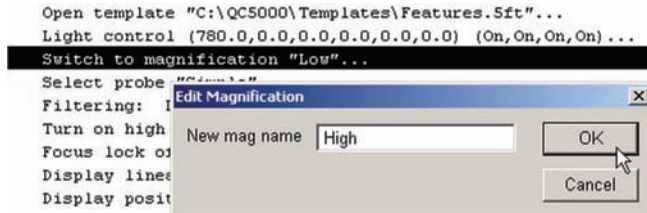

to display the Edit Magnification dialog box and enter the name of the new magnification

### Probe selection

The video probe selection is edited by double-clicking the Select probe line and selecting a different probe from a menu or toolbar. The new probe type will be displayed in the Select probe line when the editing activities are finished.

```

Switch to magnification "High"
editing Select probe "Simple"...
Filtering: Despeckle=0 Sharp
```

Double-click the Select probe line...

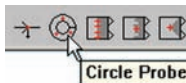

then select a probe...

```

Switch to magnification "High"
Select probe "Circle"...
Filtering: Despeckle=0 Sharp
```

to change the video probe

## High accuracy mode

The high accuracy mode optimizes feature probing as described in [Chapter 4: Probes](#). The high accuracy mode can be toggled on or off by double-clicking the High accuracy mode line.

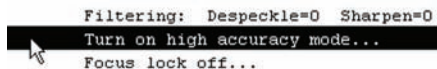

*Double-click the High accuracy line...*

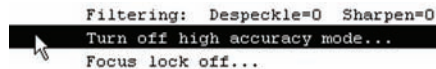

*to toggle high accuracy on or off*

## Focus lock

The focus lock function prevents Z-axis optical system changes during program execution as described later in this chapter. The focus lock function can be toggled on or off by double-clicking the Focus lock line.

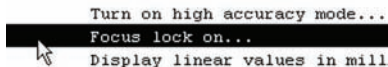

*Double-click the Focus lock line...*

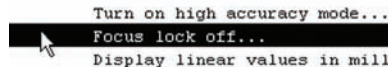

*to toggle focus lock on or off*

## Units of measure

Units of measure can be changed by double-clicking each unit of measure category line. The categories are:

- Linear values                    Toggled between millimeters and inches (as in the example below)
- Coordinate system            Toggled between Cartesian and polar
- Angular values                Toggled between degees, minutes, seconds and decimal degrees

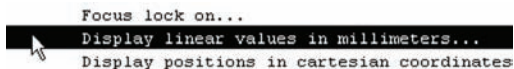

*Double-click the Display line...*

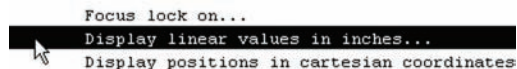

*to toggle the display between units of measure*

## Editing feature properties

By default, features are displayed in the Part View window by solid lines. The display of features can be changed to:

- Hide features
- Display features using dashed lines, as phantom features
- Display features as guidelines that by default are not measured
- Include the display of a user-defined note
- Include the display of the feature name
- Edit point filtration parameters

To begin editing feature display properties:

- 1 Double-click the desired feature program line in the Program template to display the Feature Properties dialog box.

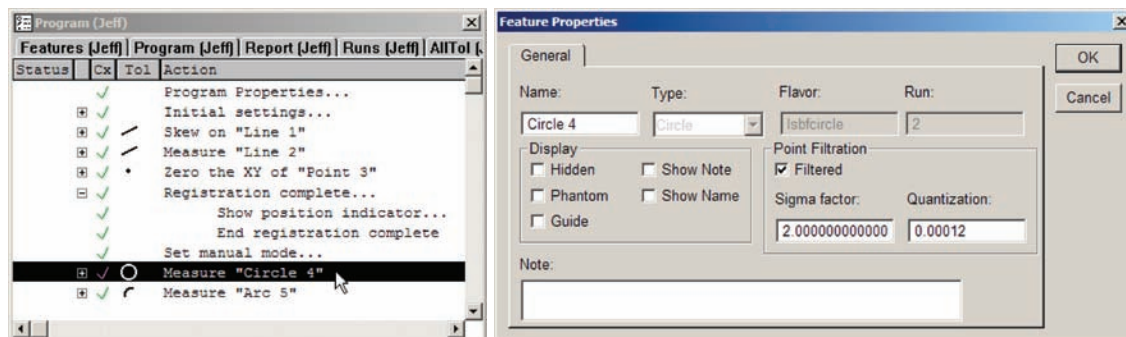

### Hiding features

To hide a feature, check the Hidden box, and then click OK.

### Displaying phantom features

All constructed features are displayed as dashed lines (phantoms) by default. To display a measured or created feature as a phantom, check the Phantom box and then click OK.

### Displaying guide features

By default, guide features are displayed as solid lines and are not measured. Guide features help operators to navigate complex parts. To display a feature as a guide feature, click the Guide box and then click OK.

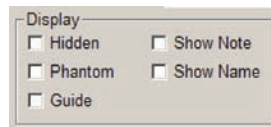

**NOTE**

A user-defined percentage of guide features can be measured by editing the runtime environment as described earlier in this chapter.

**Showing a note with a feature**

To display a note with a feature, enter the note text in the Note field, check the Show Note box and then click OK.

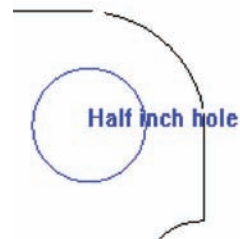
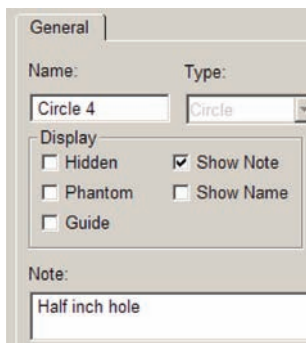
**Showing the feature name**

To display the feature name with a feature, check the Show Name box and then click OK.

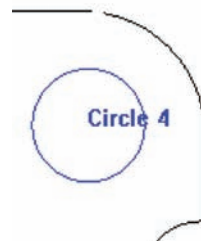
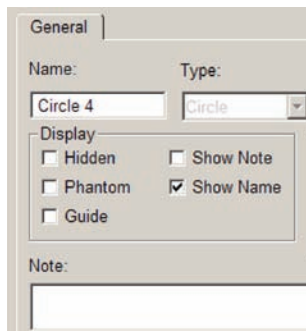
**Editing feature point filtration**

Point filtration extracts aberrant data points from the total population of points during the least squares best fit calculations of arc, circle and line features. Points are extracted when they exceed the specified error limit (Quantization factor) and fall outside the specified standard deviation range (Sigma factor). The filtration process ends when all remaining data points satisfy the quantization or standard deviation requirement, or when the Proportional Factor set in the Tools/Options/Point Filtration screen is reached.

Extracted data points are shown in the Feature Stamp window in yellow. The last points retained are shown in red.

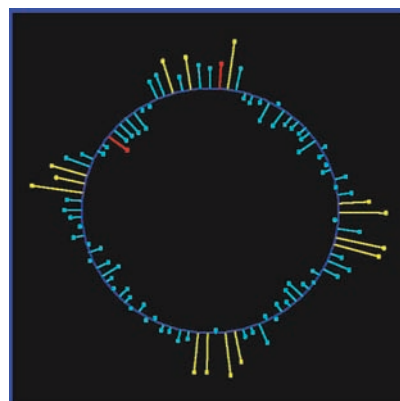
**NOTE**

The default colors of data points can be changed in the Color Custom screen of the Tools menu.

### Specifying a filtration error limit

The quantization factor is the maximum acceptable point error. It is specified by the user in millimeters. Points with errors that exceed this limit and are outside the standard deviation range are extracted from the total population.

For most measurements, the default quantization factor of 3 microns (0.00012 inch) or less can be applied. However, measurements that contain larger numbers of aberrant points might benefit from higher quantization factors.

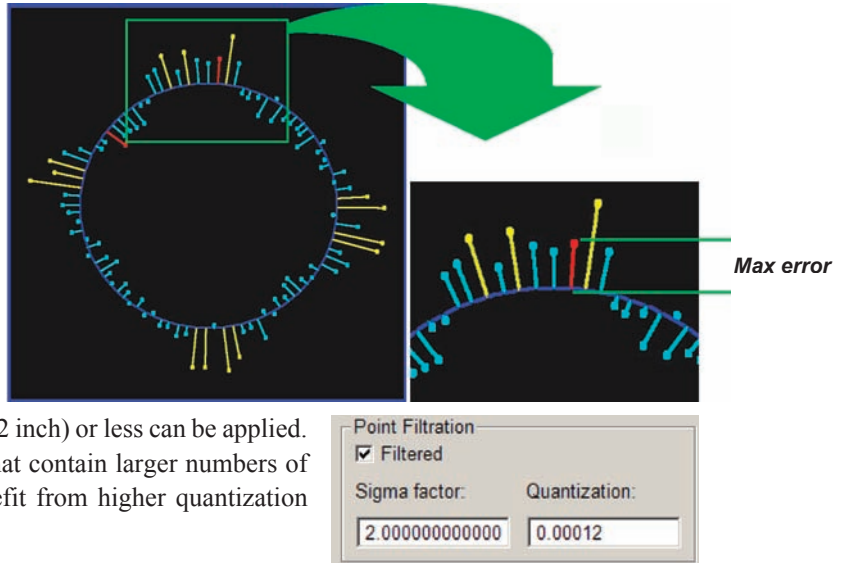

Enter the filtration error limit into the Quantization field.

### Specifying a filtration standard deviation range

The standard deviation range is a standard deviation (Sigma) of the total point population multiplied by the Sigma Factor. Points with errors that are outside the standard deviation range and exceed the quantization limit are extracted from the total population.

$$\text{Standard deviation range} = \text{Sigma factor} \times \text{Sigma}$$

In the example at the right, a Sigma factor of 2.0 produces a Standard deviation range that includes 95.5% of the total population.

$$\text{Standard deviation range} = \text{Sigma factor} \times \text{Sigma}$$

$$\text{For a Sigma factor} = 2.0,$$

$$\text{Standard deviation range} = 2 \text{ Sigma} = 0.955$$

For most measurements, a Sigma factor of 2 or more can be applied. However, measurements that include a large number of aberrant points might benefit from a lower Sigma factor.

Enter the desired Sigma factor into the Sigma Factor field.

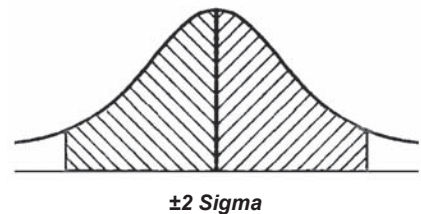
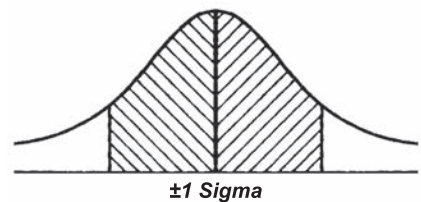

## Adding special and CNC program steps

Program steps can be added to perform a variety of functions that enhance usability and accommodate special application requirements. These functions are selected from the Tools/Programming/Special Steps and Tools/Programming/CNC Mode Steps menus and include:

- Adding a comment to the program to clarify a step or series of steps
- Adding a program time delay at a specified point during execution
- Playing a user-defined sound at a specified point during execution
- Displaying a user-defined image at a specified point during execution
- Displaying a message to the user at a specified point during execution
- Toggling the maximum program execution speed on or off. When the maximum program execution speed is toggled on, the system commitment to program execution is increased by disabling the detailed display of part view, Results window and template window activities. When the program has finished executing, these displays will be reactivated.
- Specifying full CNC or manual stage motion
- Specifying user intervention to complete a feature measurement
- Toggling the focus lock function on or off.
- Setting an output line to a logic high or low

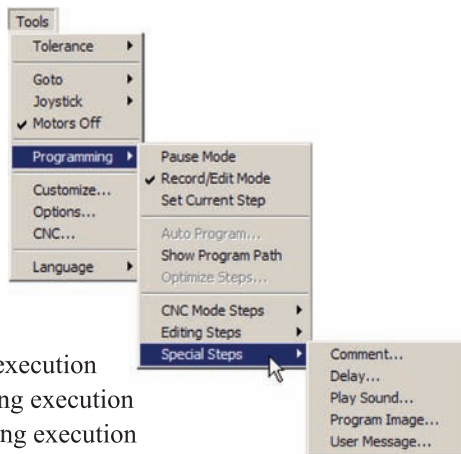

The process of adding a special or CNC step is diagrammed at the right.

### Comment

Comments can be added to the program to enhance the readability of the program listing in the Program template window. When Comment is selected from the menu, the Enter Program Comment dialog box will be displayed. Enter the desired comment and then click OK. The new comment will appear at the insertion point below the current step set earlier.

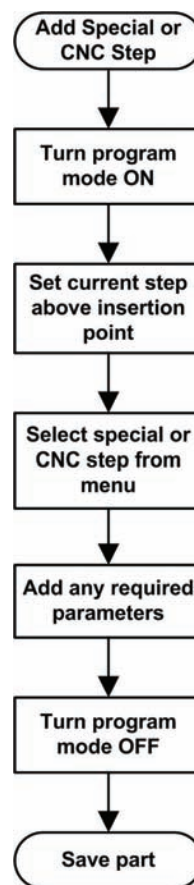
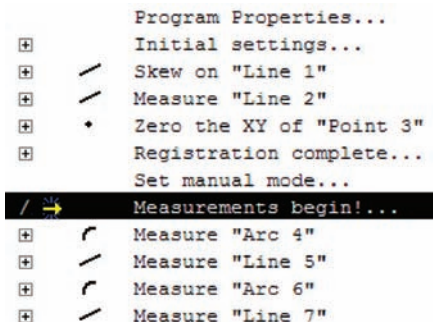
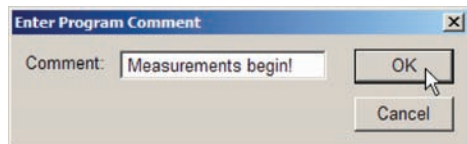



## Delay

When the QC5200 is running as part of a larger automated system measuring a series of parts, it might be necessary to pause the program execution to accommodate operator or system interaction.

When Delay is selected from the menu, the Enter Delay dialog box will be displayed. Enter the desired delay in seconds and then click OK. The new delay line will appear at the insertion point below the current step set earlier.

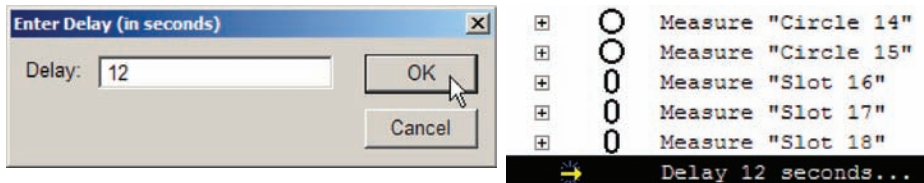

## Play sound

Audio prompting can be a valuable part of system interaction with the operator, and is especially useful when combined with user messages.

When Play Sound is selected from the menu, the Open Sound file dialog box will be displayed. Select the desired (.wav) file and then click OK. The new sound line will appear at the insertion point below the current step set earlier.

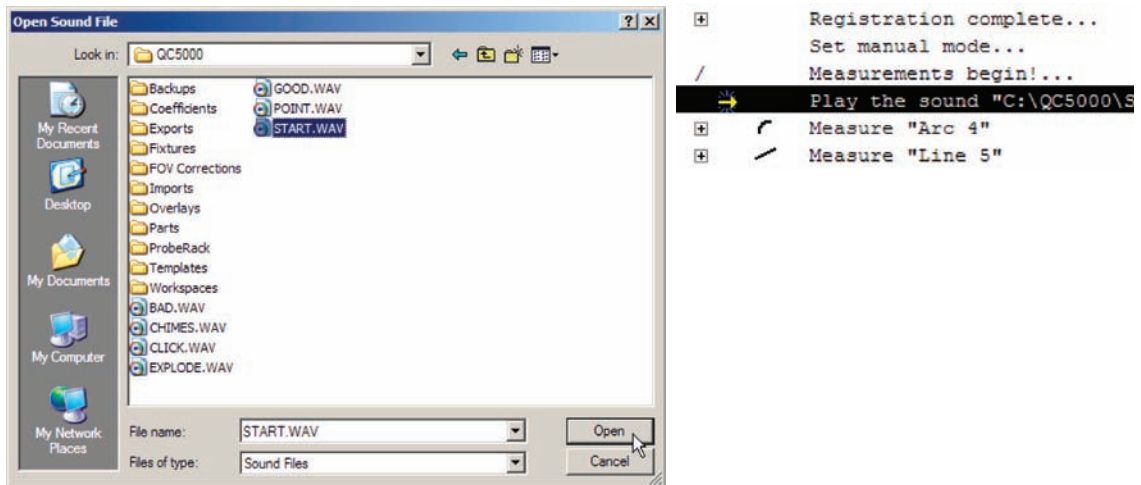

## Program image

The display of images can be a valuable part of system interaction with the operator, and is especially useful when combined with audio prompting and user messages.

When Program Image is selected from the menu, the Open Image... file dialog box will be displayed. Select the desired (.bmp) file and then click OK. The new image line will appear at the insertion point below the current step set earlier.

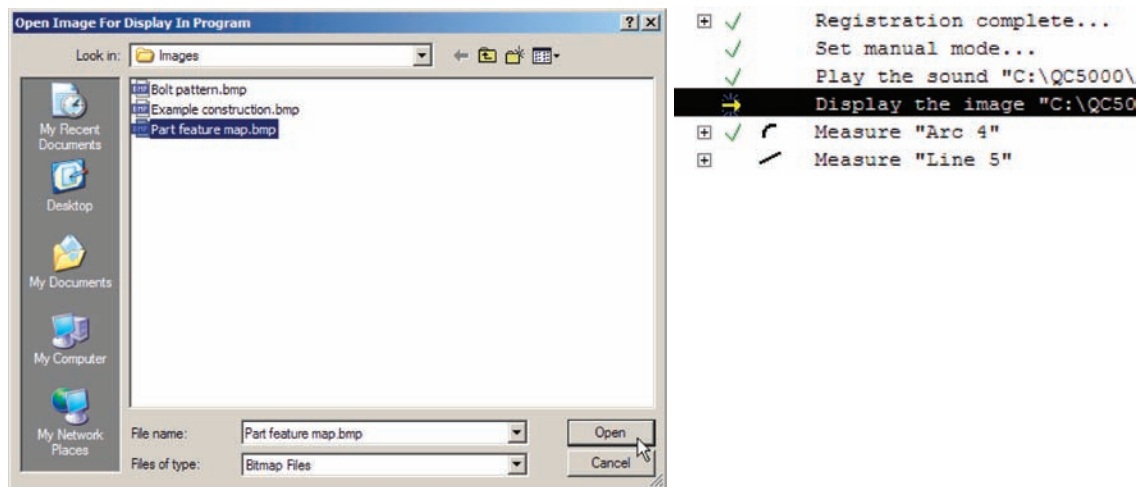

## User message

User messages can be a valuable part of system interaction with the operator, and is especially useful when combined with audio prompting.

When User Message is selected from the menu, the User Message dialog box will be displayed. Enter the desired text message and then click OK. The new message line will appear at the insertion point below the current step set earlier.

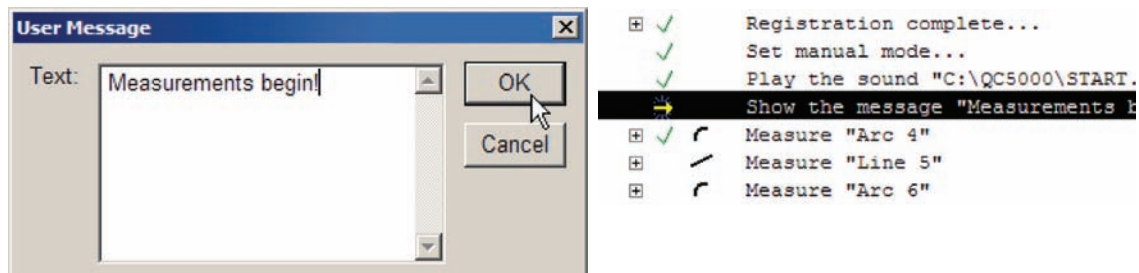

### Enabling or disabling run time graphic displays

Graphic displays of the part view and feature measurements are often useful during program execution. However, the real-time display of graphics requires the commitment of system resources. Disabling the display of graphics frees up computer resources and speeds program execution. When the display of graphics has been disabled for program execution, it will automatically be resumed when the execution is complete.

- Max speed on disables graphic displays during execution
- Max speed off enables graphic displays during execution

When Max speed on or Max speed off is selected from the menu, the new line will appear at the insertion point below the current step set earlier.

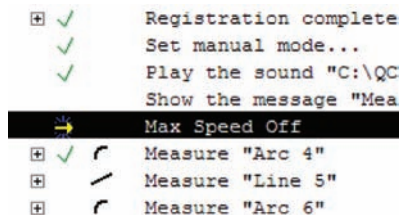

### Enabling or disabling full CNC mode

Video edge detection systems can operate in the manual or full CNC modes. In the full CNC mode the stage is moved and features are measured completely under the control of the system. In a few instances, operator intervention might be required at some point in the program execution. In these cases, the Manual mode can be enabled to permit operator intervention, and then the Full CNC mode can be enabled again to continue conducting automated measurements.

Click the desired CNC mode in the Tools/Programming/CNC Mode Steps menu, the new line will appear at the insertion point below the current step set earlier.

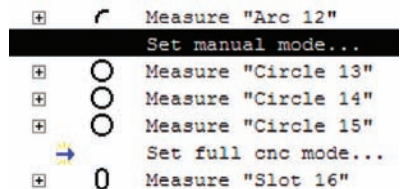
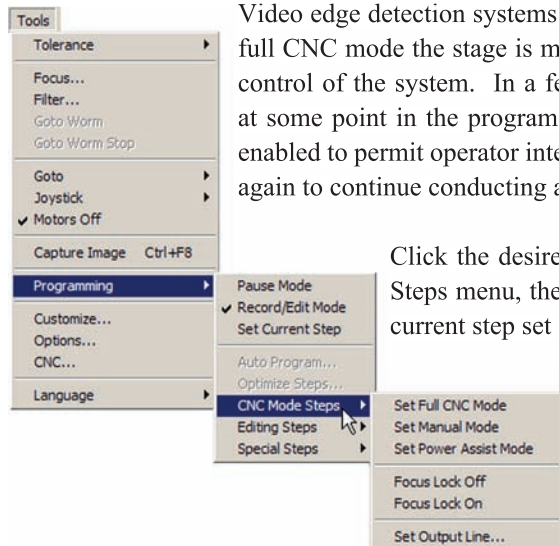

## Enabling or disabling power assist mode

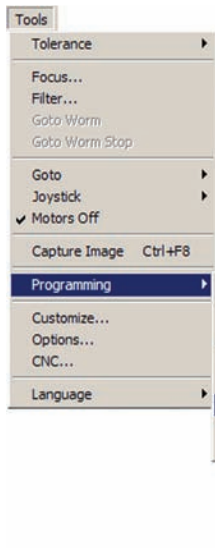

In a few instances, operator intervention might be required at some point in the program execution. Systems can execute CNC programs in the Power Assist CNC mode to include operator interaction. In this mode, the stage is driven to a feature, then control of the stage is given to the operator. When the operator completes the feature measurement, the stage is driven by the system to the next feature to be measured.

Click the Power Assist CNC mode in the Tools/Programming/CNC Mode Steps menu, the new line will appear at the insertion point below the current step set earlier.

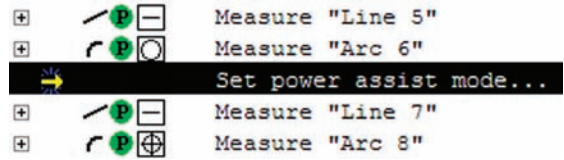

## Enabling or disabling focus lock

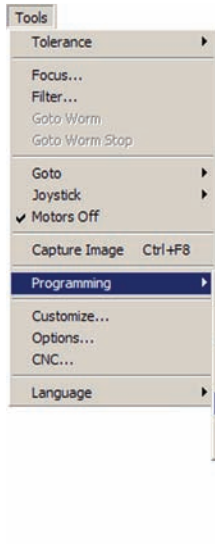

When feature measurements are being conducted by a CNC program at different Z-axis elevations, and some part variability exists, it is often necessary to reestablish a level or height measurement at each new elevation. When a new Z-axis focus is obtained, it is also necessary to lock the focus to avoid using Z-axis elevations recorded when the program was created.

Click Focus Lock On in the Tools/Programming/CNC Mode Steps menu to lock the focus, or Focus Lock Off to unlock the focus and use recorded Z-axis values. The new line will appear at the insertion point below the current step set earlier.

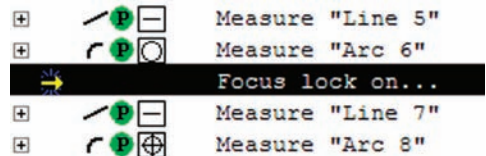

## Setting output lines



Two pins of the QC5200 axis board I/O connector and eight pins of the zoom I/O connector can be set to logic 0 or a logic 1 levels. This function is used in conjunction with hardware configurations created by the system distributor or OEM, so no specific pinout or logic level information can be provided here. Consult your system supplier for details regarding pinouts and logic levels.

To set an output line, click the Tools/Programming/CNC Mode Steps/Set Output Line function. The Set Output Line dialog box will be displayed. Consult your system I/O connection documentation and enter the line number and logic level value (1 or 0) into the fields provided.



## Selecting program steps

Program steps can be selected for editing as individual steps or as groups of steps. Any selection of steps can also be cleared simultaneously.

### Selecting individual steps

Click on any individual step to select it.



#### NOTE

When a super-step is selected, all of its subordinate steps will be included.

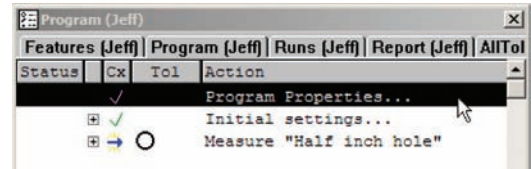

Click on a step to select it

### Selecting groups of steps

Program steps can be selected as contiguous or non-contiguous groups, and as groups of similar steps.

#### Contiguous groups

Contiguous groups of steps can be selected using the shift key or by clicking and dragging.

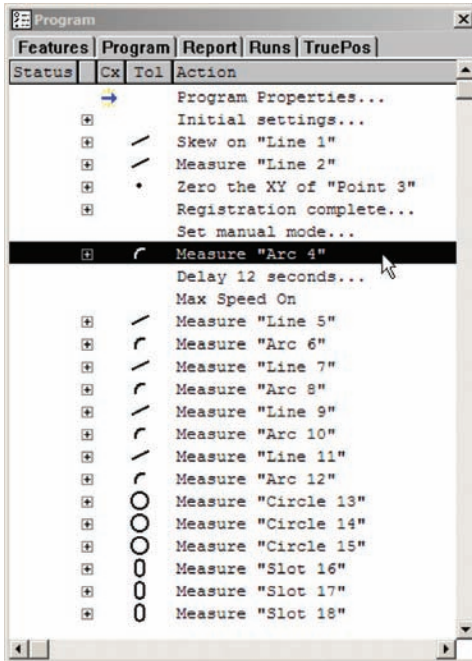

Click the first step of a group...

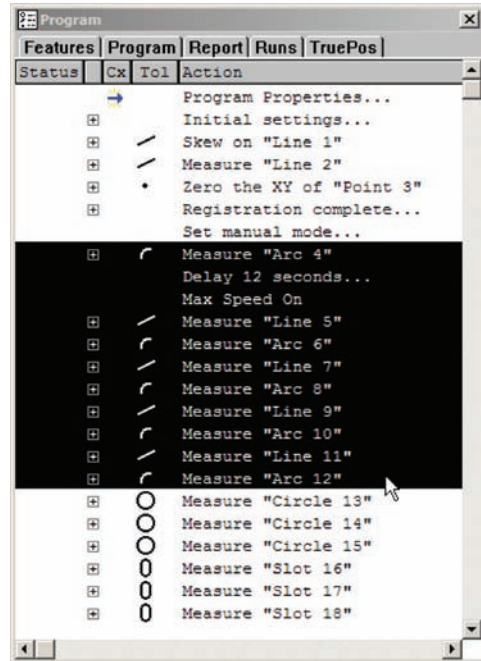

then press the shift key and click the last step

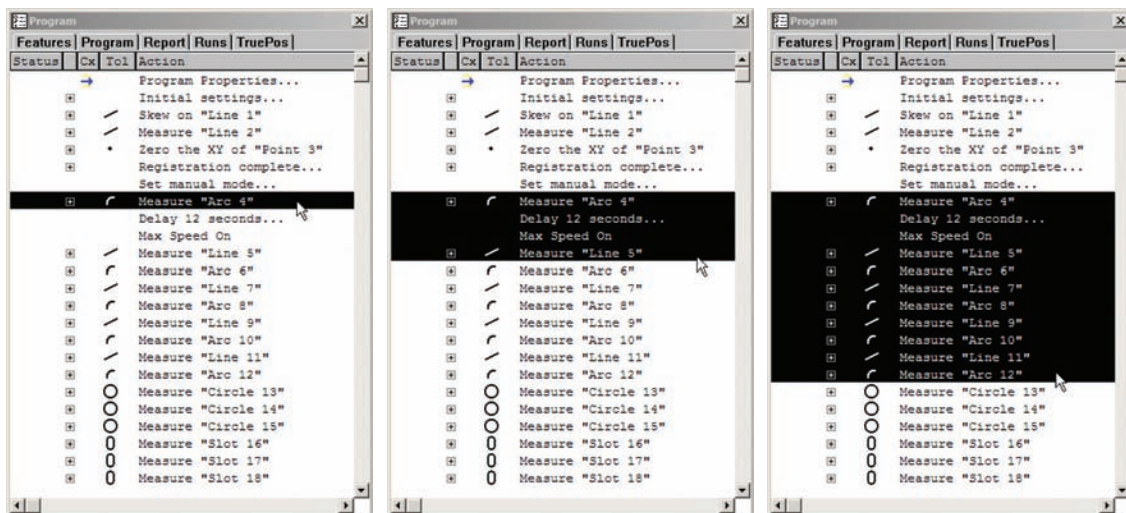

Click on the first step of a group...

and drag...

to the last step

### Selecting all steps

All of the steps contained in the Program template window can be selected using the Select All function, or by pressing the Control and A keyboard keys simultaneously.

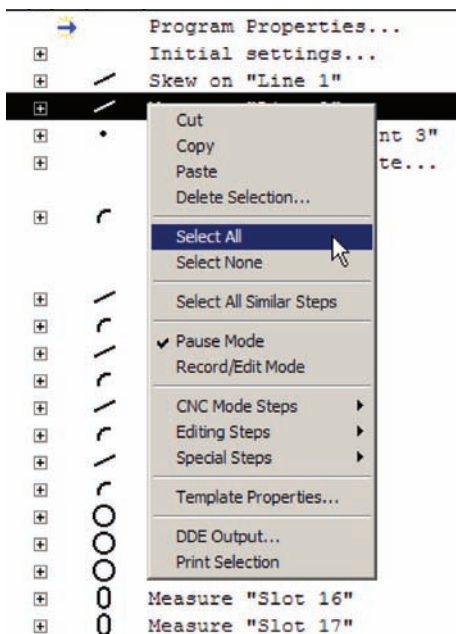

Right-click on any step, then click the Select All menu item

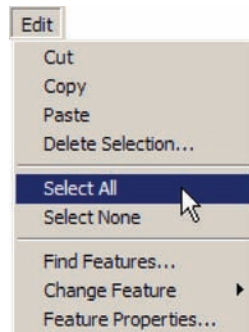

or click Select All in the Edit menu

### Non-contiguous steps

Non-contiguous groups of steps can be selected using the control key.

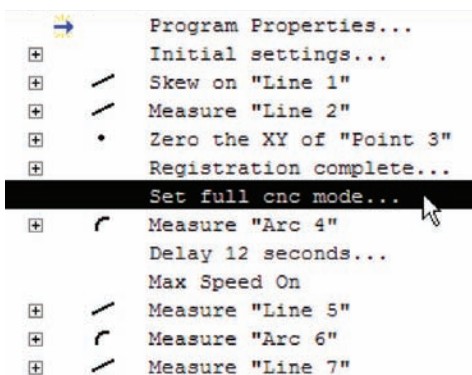

*Click the first step of a group...*

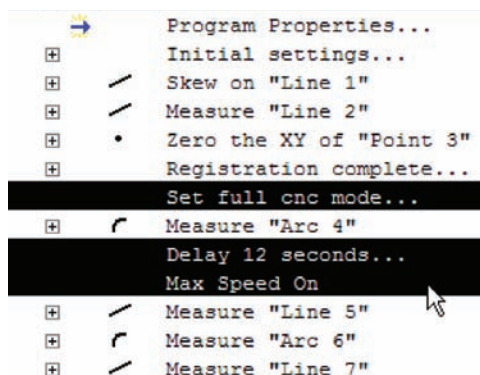

*then press and hold the control key and select the remaining steps*

### Similar steps

Often, time can be saved when similar program steps, such as Measuring steps or Max Speed steps can be selected and then enabled, disabled, copied, pasted, deleted or edited simultaneously.

To select similar steps, right-click one of the steps and then click Select All Similar Steps in the menu.

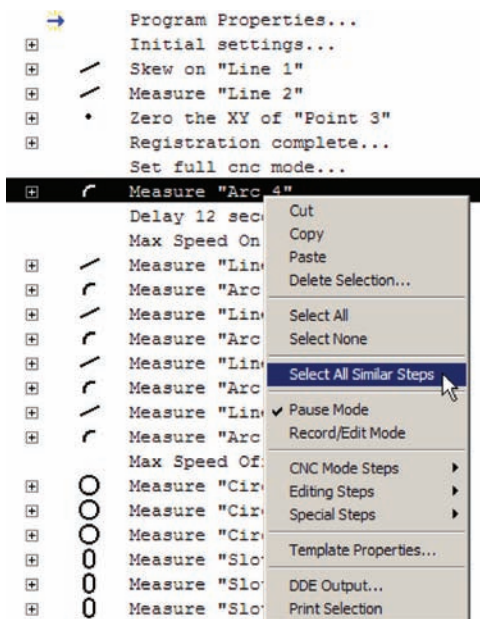

*Right-click a step...*

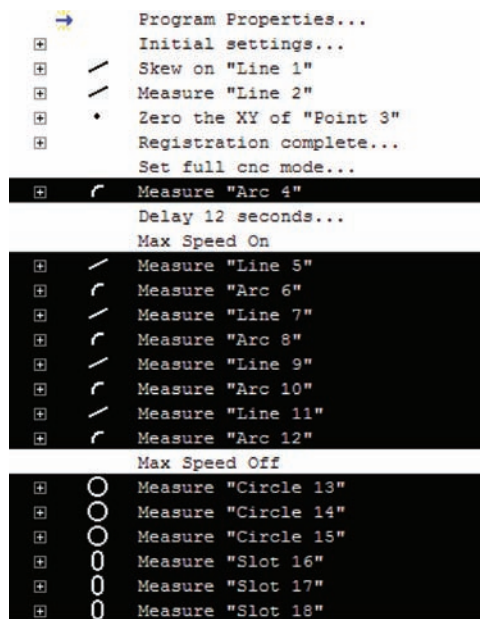

*then click the Select All Similar Steps menu item*



### Clearing step selections

Step selections should be cleared between successive edits to prevent unintended changes to program steps that were selected during a previous edit.

All step selections can be cleared simultaneously from the Program template on-screen menu or from the Edit menu.

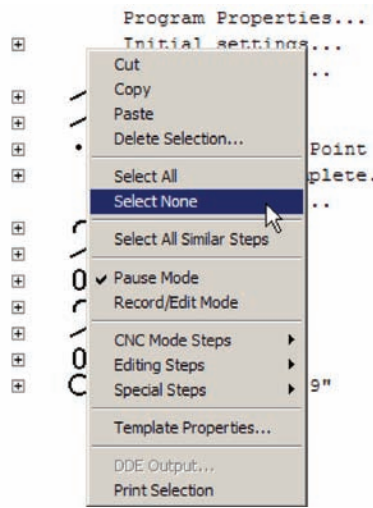

*Right-click in the Program template window and click Select None...*

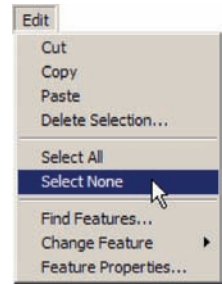

*or click the Select None Edit menu item*

## Editing individual steps

Program super steps can be expanded to show and edit individual steps. To expand a super step, click the + sign in front of the program line.

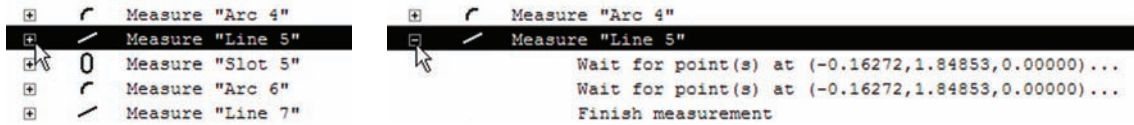

Click the + sign to...

expand the super step to show and edit individual steps

Individual steps can be edited to:

- Change the target position for probing
- Change the probing direction for point features
- Change parents of construction features
- Require user interaction to complete a measurement

## Changing the target position for probing

The CNC target position can be changed to probe a different target position when physical obstructions or other conditions make the original target position impractical. This change sometimes becomes necessary when the Auto Program function is used to create a part measuring program from a drawing file, and information regarding obstructions is not included.

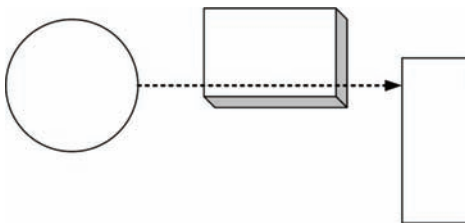

The target position on a rectangle feature...

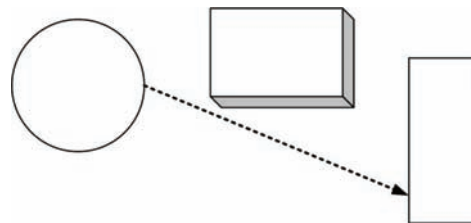

is changed to avoid an obstruction

To change a target position:

- 1 Double-click a *Wait for point* step to display the Wait for Position dialog box.

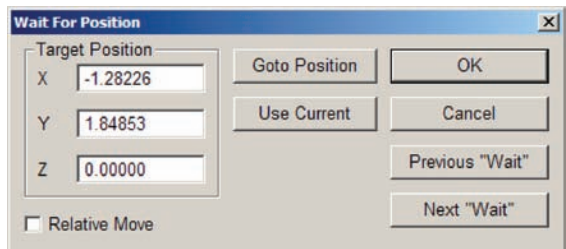
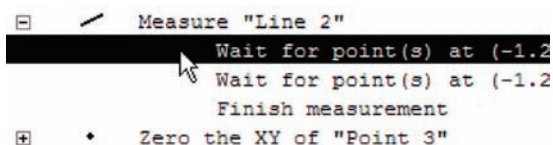

2 Use the joystick to drive the stage to the new desired target position, and then click the Use Current button. The new position coordinates will be shown in the Target Position X, Y and Z fields.

The target positions of the previous and next Wait for Point steps can be displayed by clicking the Previous Wait or Next Wait buttons. The stage can be driven to the current target position by clicking the Goto Position button.

### Changing parents of construction features

The parents of construction features can be changed by deleting program steps and then recording new steps to edit or recreate a construction, or simply by editing program steps to use different features as parents. Generally, for simple corrections, this second method is quicker. To change a parent feature:

1 Expand the construction super step by clicking the + sign in front of the step.



*Click the + sign in front of the construction ...*

*to display the construction's individual steps*

In this example, a distance construction was mistakenly made between Circle 14 and Circle 15. The correct construction would have been made between Circle 13 and Circle 14.

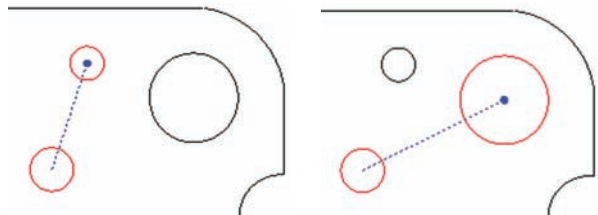

*The original construction ...*

*should have been made to a different circle feature*

2 Double-click the *Select...* program step of the parent you wish to change to display the Find Feature dialog box. In this example, Circle 15 must be changed to Circle 13.

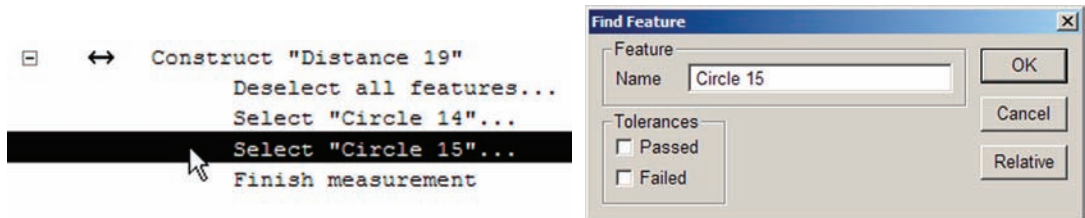

- 3 The name of the current parent feature will be shown in the Name field. Clicking the Relative button will display the relative position of the current parent feature in the program listing.

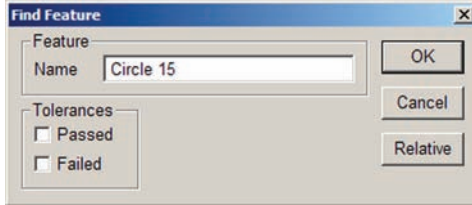

The selected feature can be shown by name...

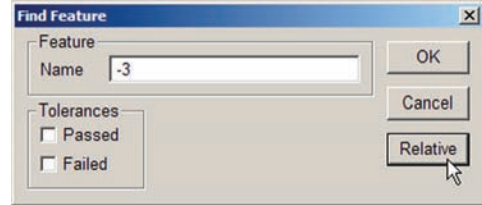

or by its relative position in the program listing

Specify the new parent feature by entering the new parent feature's name, or by entering its new relative position, and then click OK. In this example, Circle 15 must be changed to Circle 13 to create the correct distance construction.

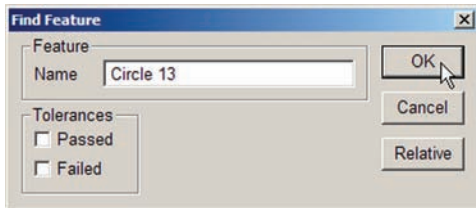

The new feature name...

```

☐ ↔ Construct "Distance 19"
      Deselect all features...
      Select "Circle 14"...
      Select "Circle 13"...
      Finish measurement
  
```

will be included in the program listing

The next time the program is executed, the new construction will be created from the correct parent features.

### Requiring user interaction to complete a measurement

Sometimes the user will want to pause the program execution to verify or adjust a profile fit before completing a profile measurement. Other measurements might also require user interaction to complete. To require user completion of a measurement:

- 1 Expand the measurement super step by clicking the + sign in front of the step.

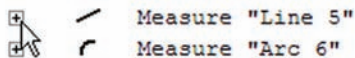

Click the + sign in front of the measurement ...

```

☐ / Measure "Line 5"
    Wait for point(s) at
    Wait for point(s) at
    Finish measurement
  
```

to display the measurement's individual steps

- 2 Double-click the Finish measurement step to change it to User finish measurement.

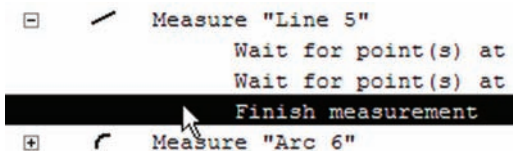

```

☐ / Measure "Line 5"
    Wait for point(s) at (-0.:
    Wait for point(s) at (-0.:
    User finish measurement
☐ / Measure "Arc 6"
  
```

## Optimizing program steps

When a program runs, the user is guided (or the CNC stage is driven) along a path that follows the feature shapes as points are probed. This path is either the exact path followed by the user as measurements were recorded or is the path assigned by the system during Auto programming. Often this path is not the most efficient and the throughput can be increased by shortening or optimizing it. The Optimize Steps function creates a more efficient path for any collection of program steps highlighted in the Program template. The Optimize steps function is described in detail earlier in this chapter in the *Creating Programs* section.

## Cutting, copying, pasting and deleting program steps

The Cut, Copy, Paste and Delete editing functions can be accessed from the Program template on-screen menu or from the Edit menu.



**CAUTION**  
Save your file before cutting or deleting steps.

### Cutting steps

Select the step(s) to be cut and click Cut in the on-screen or Edit menu. The selection will be removed from the program listing and placed on the Windows clipboard. The clipboard contents can be pasted later if desired.

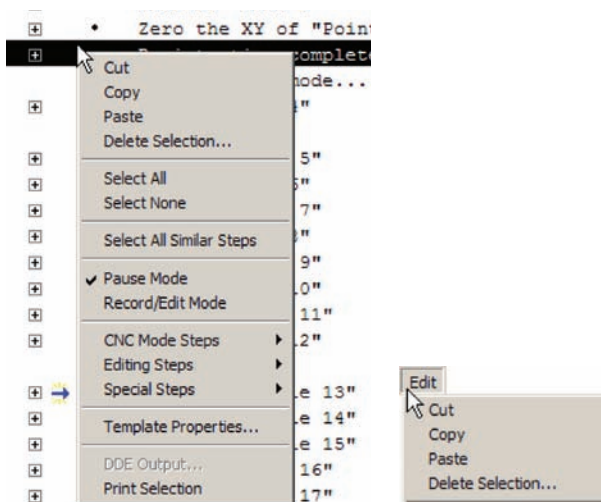

Right-click in the Program template window...

or click the Edit menu

### Copying steps

Select the step(s) to be copied and click Copy in the on-screen or Edit menu. The selection will be placed on the Windows clipboard. The clipboard contents can be pasted later if desired.

### Pasting steps

Select the step above the desired insertion point and click Paste in the on-screen or Edit menu. The contents of the clipboard will be pasted below the previously selected step.

### Deleting steps

Select the step(s) to be deleted and click Delete in the on-screen or Edit menu. The selection will be deleted.

## Inserting new program steps

New measurements are inserted into an existing program by selecting an insertion point and recording the steps. This simple process is slightly different for measurement steps that are dependent on run-time environment parameters that might have changed since the program was initialized. This is because the system retains the run-time parameters from the last measurement. So for example, if a program completes execution and then a new step is inserted, the run-time parameters retained from the end of the program could inappropriately be applied at the insertion point.

Run-time parameters that should be considered when inserting new steps include:

- Datums
- Lighting
- High accuracy mode
- Magnification value
- Focus lock
- Units of measure
- Constructions
- Template state

When it is clear that no run-time parameter conflicts will exist, the process of inserting new steps is quite simple, as shown here.

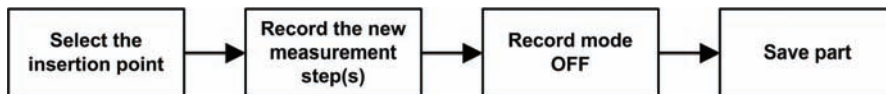

However, if it's possible that run-time parameter conflicts exist, the more reliable method is executing the program to the insertion point and then inserting the new step. This ensures that all run-time parameters will be consistent with the step at the insertion point.

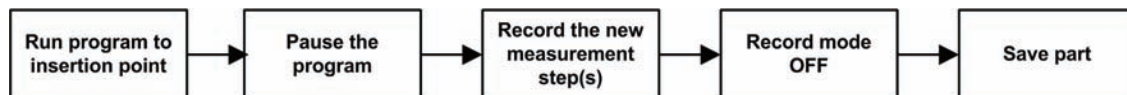

If there are any questions regarding run-time parameter conflicts, use this second process to insert new steps.



### NOTE

The program can be single-stepped to the insertion point. Refer to the next section on Debugging for details regarding the single-step function.

## Debugging programs

Occasionally, if programs do not produce the planned results, it can be useful to include breakpoints in the program that halt execution at specified program lines. It can also be useful to single-step through program execution and observe measurements in the part view window and values in the DRO. In addition to controlling program execution, specific program steps can be temporarily disabled to speed program evaluation.

### Inserting breakpoints to pause program execution

Any number of breakpoints can be inserted at program line locations specified by the user. The program will pause execution when it encounters a breakpoint. To insert a breakpoint:

- 1 Right-click the program line that will pause the program to display the Program window on-screen menu.
- 2 Click the Editing Steps/Toggle Break Point menu item. A breakpoint will be inserted into this line, and will be indicated by a stop sign icon.

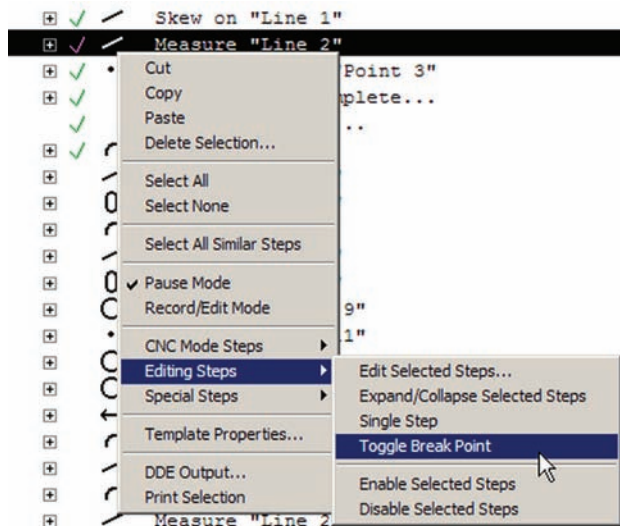
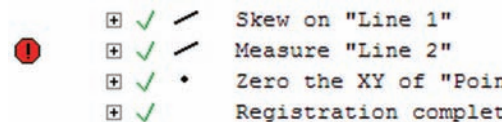

### Removing a breakpoint

To remove a breakpoint, right-click the breakpoint line and then click the Editing Steps/Toggle Break Point menu item.

### Resuming program execution after a pause

Execution can be resumed by clicking the Run Program From Current Step toolbar icon button.



## Single-stepping program execution

Program execution can be single-stepped from the beginning, from the current step or from any point at which the program execution has been paused by a breakpoint. Each single-step executes an individual program line, not a super step. For example, if a line is measured by acquiring 4 points, single-stepping through the line measurement will require 4 steps. The current step indicator follows the single-step execution as the program is single-stepped. To single-step program execution:

- 1 When the program is paused at the current step or breakpoint, click the Run Just Current Step toolbar icon button. The current step arrow will indicate the step location.



## Disabling program steps

Individual program steps can be disabled to prevent their execution and speed evaluations of other program content. In this example, in order to speed execution to the measurement of Slot 8, the 5 preceding feature measurements are disabled. To disable program steps:

- 1 Highlight and then right-click the steps you wish to disable.

- 2 Click the Editing Steps/Disable Selected Steps menu item. The disabled steps will be indicated by red icons in front of the program listing.

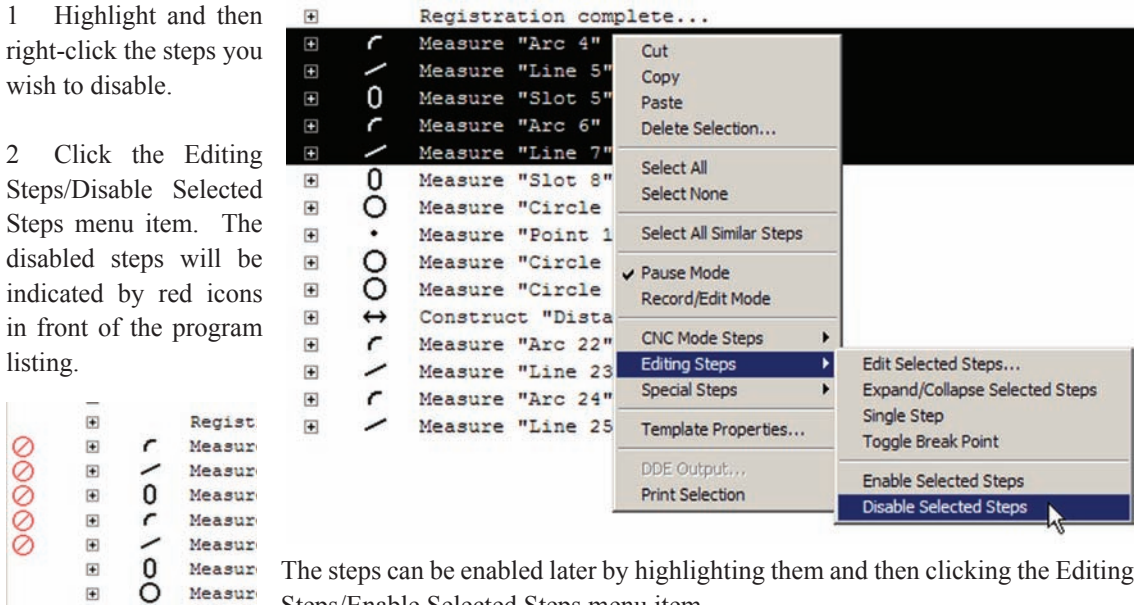

The steps can be enabled later by highlighting them and then clicking the Editing Steps/Enable Selected Steps menu item.



# Chapter 9: Encoder Setup

The Encoder Setup program is used to define encoder types and calibrate analog axis encoders. Each axis can be configured independently to accept input counts from an analog or from a TTL encoder. Analog encoders require calibration, TTL encoders do not.



## NOTE

Only analog encoders must be calibrated.



## WARNING

Confirm that power is not applied to the axis motors before proceeding to eliminate the possibility of unexpected motor runaway.

## TTL encoders

The only setup requirement for TTL encoders is the definition of encoder type. Axis motors do not require operation for this task.

- 1 Launch the Encoder program and click the desired Axis radio button, and then click the TTL Axis Scale Type.

| Axis                                    | Axis Scale Type                            |
|---|--|
| <input checked="" type="radio"/> X Axis | <input type="radio"/> Current (Heidenhain) |
| <input type="radio"/> Y Axis            | <input type="radio"/> Voltage              |
| <input type="radio"/> Z Axis            | <input checked="" type="radio"/> TTL       |
| <input type="radio"/> Q Axis            | <input type="radio"/> Pseudo Sinusoidal    |

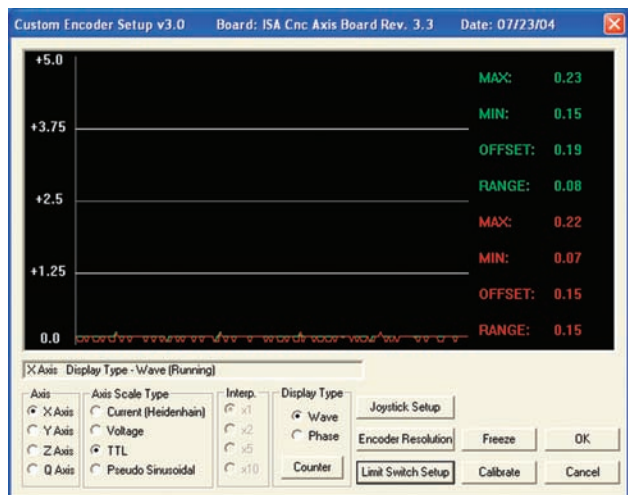

- 2 Repeat step 1 for all axes using TTL encoders.

**NOTE**

Select pseudo-sinusoidal if TTL encoder outputs are degraded by capacitance in the cabling/wiring.

- 3 Center the axes using the joystick, close the Encoder Setup program and proceed to QC5200 Encoder Setup later in this chapter.

## Analog encoders

Analog encoders must be specified as an encoder type and then calibrated. The calibration process requires encoder movement that in most cases can only be created by operating the axis motors.

**WARNING**



Operating axis motors without PID loop control is potentially dangerous since the motors will be operating in an open-loop mode. To minimize the potential hazards of open-loop motor operation, tools are included in the encoder setup program for limiting the maximum axis velocity and enabling limit switches for each axis.

**NOTE**

Joystick settings will only be applied while the encoder setup program is active. Permanent settings will be configured later in the QC5200 program.

## Joystick setup and limiting maximum axis velocity

Motor operation will be controlled by the joystick. Configure the joystick and specify the maximum axis velocities before applying power to the axis motors.

- 1 Click Joystick Setup  to display the Joystick Setup screen shown on the next page.
- 2 Move the joystick through its entire range of motion for all axes, then click Apply Cal. 
- 3 Specify the desired parameter for each joystick axis:
  - Dead band           % of inactivity range around joystick rest position
  - Normal speed       % of the maximum axis velocity
  - Fine speed           % of the maximum axis velocity
  - Curvature           % of exponential velocity control (refer to the graph on the next page)

**Joystick Setup**

| X Axis                | Y Axis               | Z Axis                | Q Axis               |
|-----------------------|----------------------|-----------------------|----------------------|
| Current: 2.500        | Current: 2.500       | Current: 2.515        | Current: 2.534       |
| Maximum Value: 4.976  | Maximum Value: 4.995 | Maximum Value: 4.995  | Maximum Value: 2.651 |
| Center: 2.52          | Center: 2.51         | Center: 2.53          | Center: 2.53         |
| Minimum Value: -0.083 | Minimum Value: 0.015 | Minimum Value: -0.083 | Minimum Value: 2.515 |

**CAL CENTER**      **APPLY CAL**

| X Axis               | Y Axis               | Z Axis               | Q Axis               |
|----------------------|----------------------|----------------------|----------------------|
| Deadband: 8.00       | Deadband: 8.00       | Deadband: 8.00       | Deadband: 8.00       |
| Normal Speed: 100.00 | Normal Speed: 100.00 | Normal Speed: 100.00 | Normal Speed: 100.00 |
| Fine Speed: 25.00    | Fine Speed: 25.00    | Fine Speed: 25.00    | Fine Speed: 25.00    |
| Curvature: 0.00      | Curvature: 0.00      | Curvature: 0.00      | Curvature: 0.00      |

Enable     Reverse   
 Enable     Reverse   
 Enable     Reverse   
 Enable     Reverse

Use Y Joystick     Use Z Joystick   
 Use X Joystick     Use Z Joystick   
 Use X Joystick     Use Y Joystick   
 Use X Joystick     Use Y Joystick

**APPLY SETTINGS**    Stepper     **CLOSE**

Set the normal speed at a fraction of the maximum axis velocity as a safety precaution.

4 Click the Enable  Enable box of each axis that will be moved by a motor during calibration.

5 Click the Reverse  Reverse box of any axis to reverse its direction if required.

6 Click a Use Joystick box to change the control axis if necessary.  Use Y Joystick     Use Z Joystick

7 Click Apply Settings **APPLY SETTINGS** to save the joystick settings and then click Close **CLOSE** to return to the Encoder Setup screen.

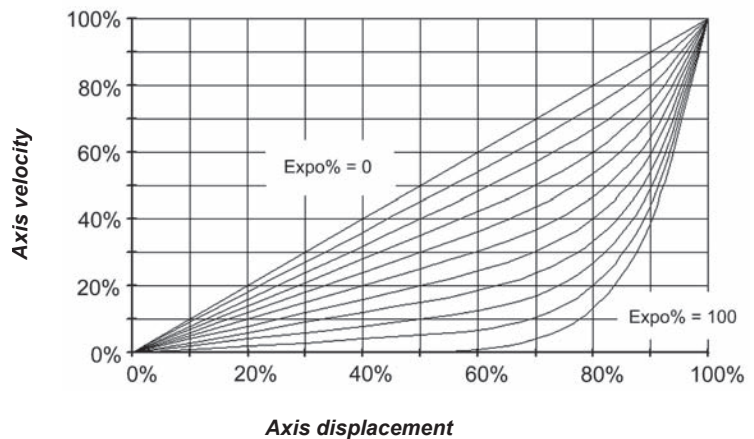

**Curvature joystick parameter**

## Counter setup

The counter window will display changing displacements as the axes are moved. Each axis is given a default encoder resolution. The axis resolutions can be changed to indicate accurate axis displacements during calibration.



### NOTE

**This feature is only provided as a convenience to the user, will not be retained when the program is closed and is not necessary for encoder calibration.**

To change the counter display:

- 1 Click Encoder Resolution  to display the data entry fields.
- 2 Enter the axis encoder resolutions into the Axis fields and click OK to return to the Encoder Setup screen.

## Limit Switch setup

Limit switches can be used to prevent axis travel beyond predetermined points. Axis limit switches can be configured to be active when low (0 volts), or to be active when high (5 volts).

To configure axis limit switches:

- 1 Click Limit Switch Setup  to display the limits which window.
- 2 Enter 0 for axis limit switches that will be active when low (0 volts). Enter 1 for axis limit switches that will be active when high (5 volts).
- 3 Check Swap Limit Switches to exchange the Plus and Negative switches of an axis.
- 4 Check the Enable box to enable limit switches for each axis.
- 5 Click OK to return to the Encoder Setup screen.

# Calibrating analog encoders

Analog encoders require calibration. The process of calibrating analog encoders is very straightforward and is identical for current and voltage output devices. To calibrate an analog encoder:

1 Select the desired axis, confirm that the correct Axis Scale Type is selected and click the Wave Display Type.

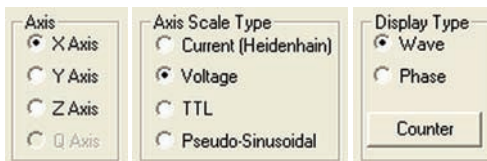

2 Click the Calibrate  button. You will be instructed to move the axis. Begin moving the axis in slow, gradual back and forth or up and down motions, and click OK. The sine wave output of the analog encoder will be displayed as the axis is moved. The display is shown as two sine waves that are 90 degrees out of phase. The real-time display changes as the encoder is moved, however, still images can be captured for evaluation at any time by clicking the Freeze button.

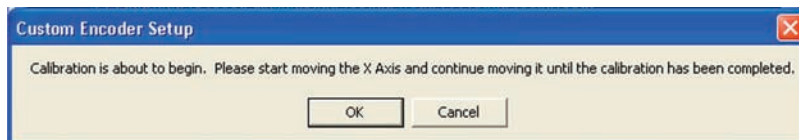

After a moment the Custom Encoder Setup window will also be displayed and will show the changing encoder output count value and the number of count errors detected since the calibration began.

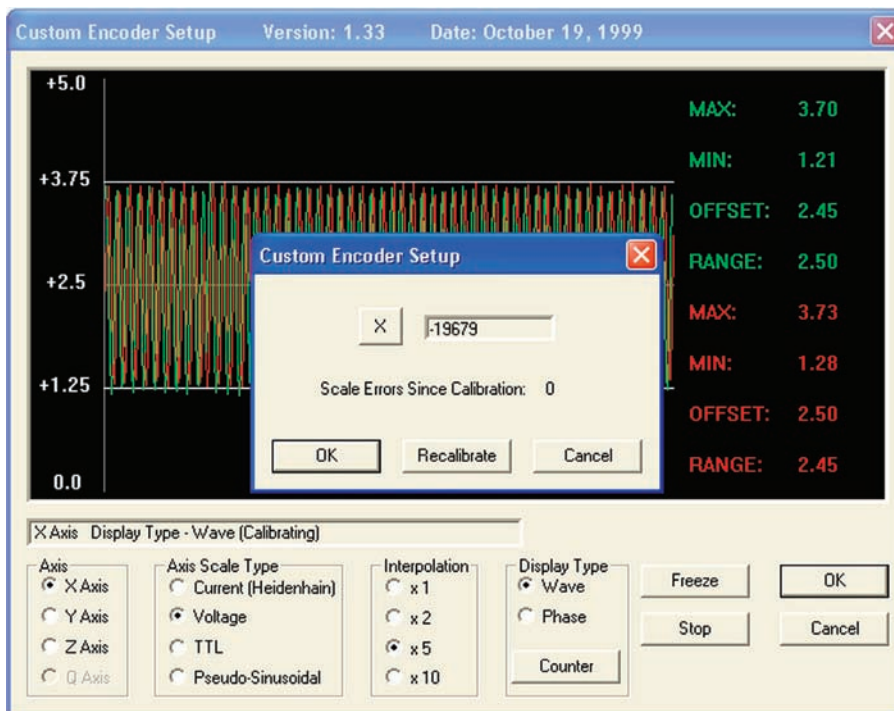

- 3 Continue moving the encoder slowly between the limits of motion until a few full limit-to-limit motions have been completed.

**NOTE**

The wave shape can include imperfections that won't affect the accuracy of measurements. However, erratic frequency or amplitude variations or high noise content can cause inaccuracies. If any erratic output is noted, or if scale errors appear, check the encoder head mounting, alignment and wiring for problems.

- 4 When a few full limit-to-limit motions have been completed without scale errors, click OK to close the Custom Encoder Setup window and proceed to the next step.

The display of scale and error counts can be recalled at any time by clicking the Counter button.

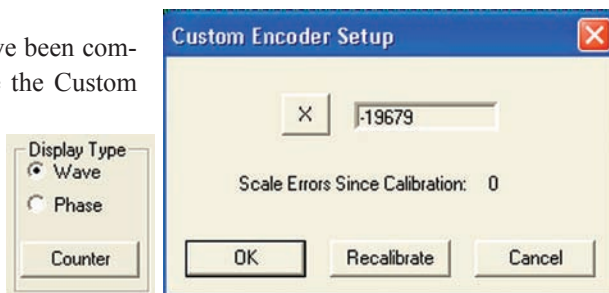

- 5 Select the Phase Display Type to display the combined phases of the encoder output as an ellipsoidal pattern in the Custom Encoder Setup window when the encoder is moved slowly between the limits of motion. Move the encoder and evaluate the resulting pattern.

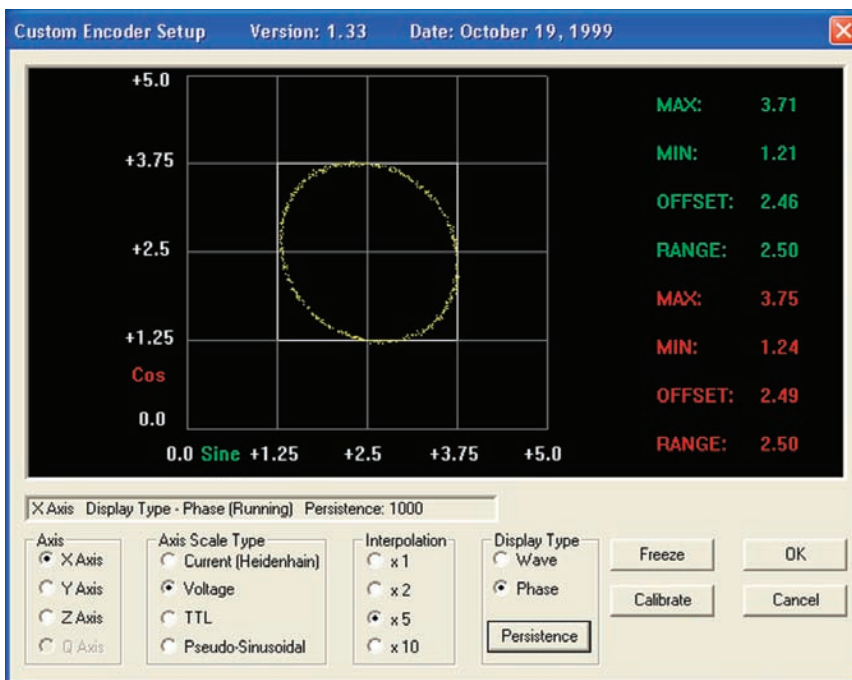
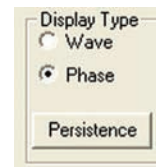

The relative brightness of the pattern can be changed to facilitate the evaluation. Click the Persistence button to display the Persistence Adjustment data field. The persistence of the pattern image can be changed from 1 to 1000. Higher numbers result in brighter pattern images.

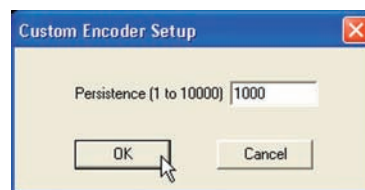

The combined-phase pattern will form a circle when the encoder output phase amplitudes are equal. Generally when the pattern displayed is not circular, the reader head will need to be realigned, and the encoder recalibrated from the beginning.

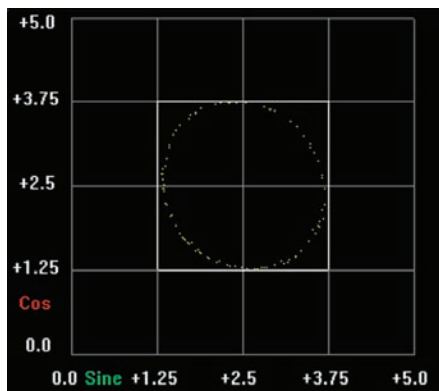

*A persistence of 100 produces a dim display*

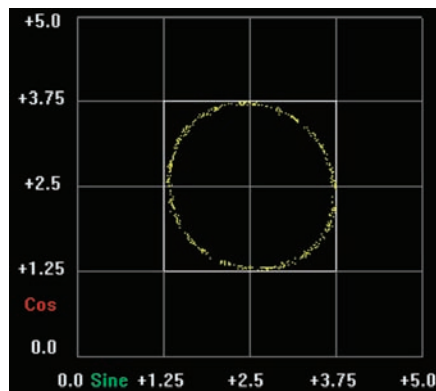

*A persistence of 1,000 produces a bright display*



### CAUTION

Encoder reader head realignment and any other encoder maintenance or repair should be performed only by your OEM or Metronics distributor.

6 When the pattern is circular, repeat the process described in steps 1 through 5 to calibrate any remaining analog encoders.

7 Close the Encoder Setup program, Center the stage axes using the joystick and proceed to [QC5200 Encoder Setup](#) next in this chapter.

## QC5200 encoder setup

Most encoder setup activities were completed using the Encoder Setup program. The remaining encoder setup tasks must be performed using the QC5200 program.

- 1 Confirm that the power is not applied to axis motors.
- 2 Launch the QC5200 program, and then click the Tools/Options/Encoders tab to display the Encoder Setup screen.

Use the encoder screen to specify encoder resolution, units of measure, count direction and reference mark type.

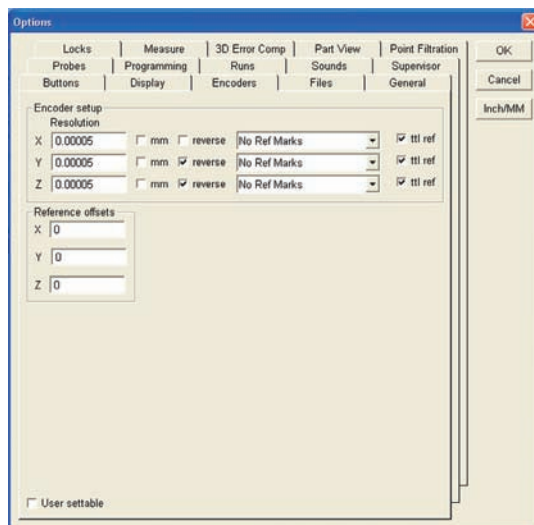

### Specifying encoder resolution

Enter the resolution specification of the encoders used with your system into the X, Y and Z Resolution fields.

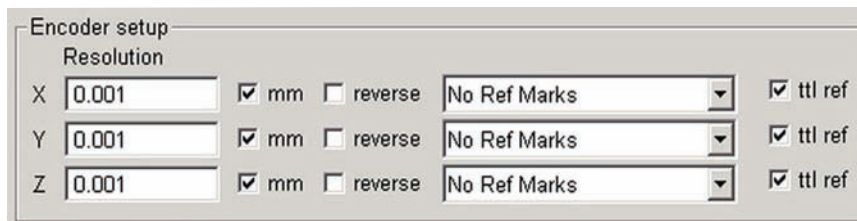

### Specifying encoder unit of measure

Check the mm box for metric encoders, or clear the mm box for encoder output values in inches.

### Specifying encoder count direction

Check or clear the reverse boxes to achieve the desired DRO count directions.

### Specifying encoder reference marks

Highlight the desired reference mark type in the drop-down lists, and then clear the TTL Ref box for analog reference marks.



## Specifying reference offsets

The Reference offsets fields are used to move the location of the system's machine zero. Enter any required offsets into the fields provided.

This completes encoder setup.

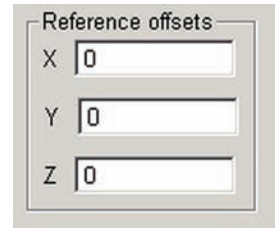

A dialog box titled "Reference offsets" with three input fields. The first field is labeled "X" and contains the value "0". The second field is labeled "Y" and contains the value "0". The third field is labeled "Z" and contains the value "0".

| Reference offsets |   |
|-------------------|---|
| X                 | 0 |
| Y                 | 0 |
| Z                 | 0 |

# Chapter 10: Supervisor Setup

Setup screens are often made available to the supervisor by the OEM or Metronics distributor for customizing display and some measurement parameters. The specific screens that are available are determined for each system by the OEM or distributor responsible for system setup and maintenance. A collection of setup screens typically made available to supervisors is included in this chapter. Some of these screens can also be made available to the end-users by the supervisor. The setup screens omitted from this chapter are not intended for supervisors or end-users. Setup screens presented in this chapter are listed below:

## Tools/Customize menu item screens

|   |     |
|---|-----|
| Including a startup message .....       | 300 |
| Customizing colors .....                | 301 |
| Specifying on-screen help tips .....    | 305 |
| Specifying error messages .....         | 306 |
| Specifying status bar information ..... | 308 |
| Customizing toolbars .....              | 309 |

## Tools/Options menu item screens

|  |     |
|--|-----|
| Setting up programming parameters .....                        | 314 |
| Specifying the maximum program executions .....                | 317 |
| Restricting access to setup screens .....                      | 318 |
| Configuring measurement parameters .....                       | 320 |
| Displaying parts and probe position .....                      | 322 |
| Configuring joystick and footswitch buttons .....              | 327 |
| Setting the display of resolution, time and date .....         | 330 |
| Specifying encoder parameters .....                            | 331 |
| Specifying file names, locations and backups .....             | 332 |
| Setting serial port, machine zero and general parameters ..... | 337 |
| Setting up the video probes .....                              | 340 |

## Tools/CNC menu item screens

|                               |     |
|-------------------------------|-----|
| Setting up the joystick ..... | 350 |
|-------------------------------|-----|

## Including a startup message

The Misc screen contains a data field for entering a message that will be displayed when the QC5200 program is started.

The message field is empty by default.

Click the Tools/Customize/Misc menu item to display the Misc screen.

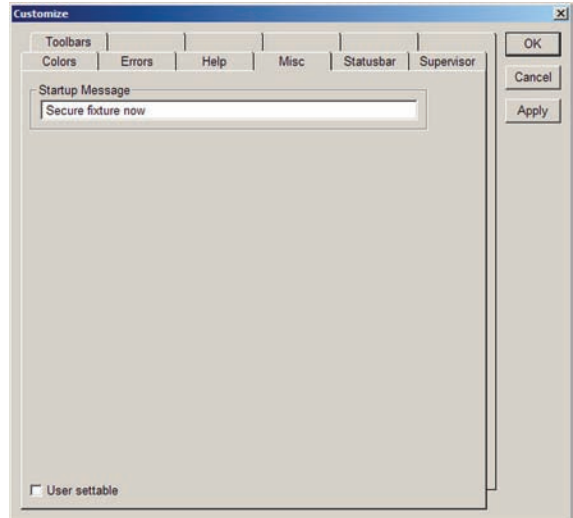

# Customizing colors

Most items on QC5200 screens are displayed in colors that can be changed using tools provided on the Colors screen.

The default color of each item is shown next to the items name in the list box.

Click the Tools/Customize/Colors menu item to display the Colors screen.

## Changing item colors

To change the color of an item:

- 1 Scroll to the desired item if necessary and highlight it by clicking the mouse cursor on the item name.
- 2 Click the Set Color button. The color palette will be displayed.
- 3 Click the new color for the selected item and click OK.

## Color list items

Items included in the list are shown below and described in subsequent pages.

- DRO Axis
- DRO Digits
- DRO Window
- Feature Stamp Background
- Feature Stamp Filtered
- Feature Stamp Selected Point
- QC5200 Window
- Results Text
- Results Window
- Part View Parents
- Part View Probe Indicator

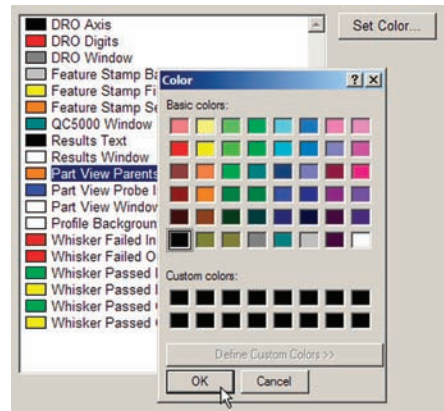
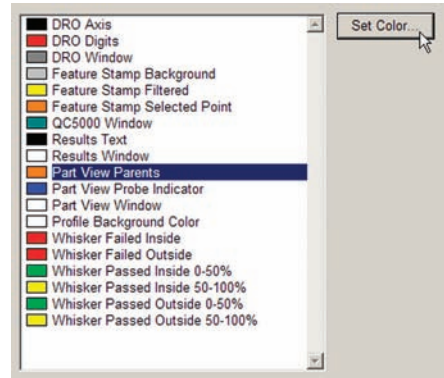
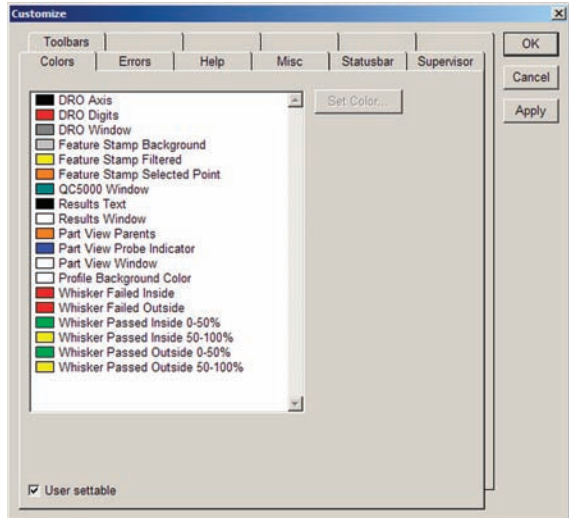

- Part View Selection Border
- Part View Window
- Profile Background Color
- Whisker Failed Inside
- Whisker Failed Outside
- Whisker Passed Inside 0-50%
- Whisker Passed Inside 50-100%
- Whisker Passed Outside 0-50%
- Whisker Passed Outside 50-100%

### ***DRO axis, digits and window***

DRO colors that can be changed are shown below:

The default colors are:

- Axis: Black
- Digits: Red
- Window: Gray



### ***Feature stamp background, filtered and selected point***

The feature stamp colors that can be changed are shown below:

The default colors are:

- Selected: Orange
- Background: Black
- Filtered: Yellow

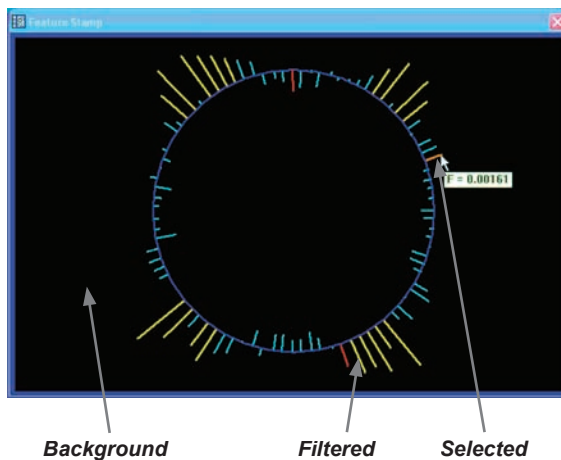

### QC5200 workspace

The QC5200 workspace background color can be changed.

The default color is dark green

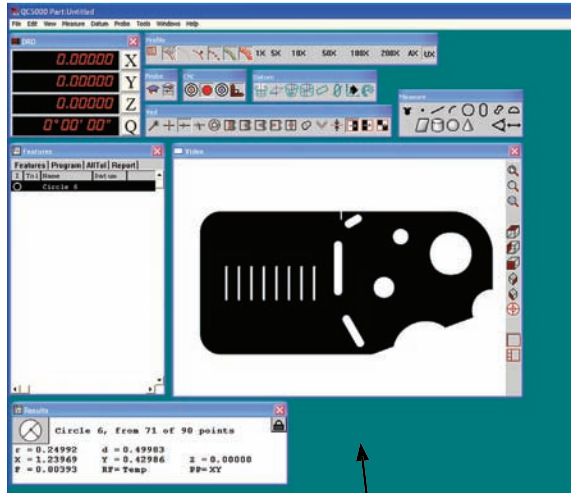

Window background

### Results text and window

The Results window colors can be changed.

The default colors are:

- Text: Black
- Window: White

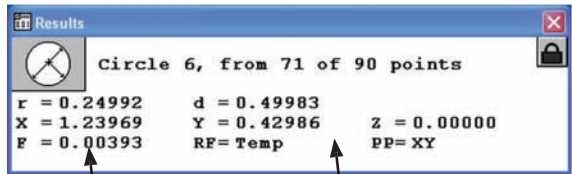

Text

Window background

### Part view parents, probe indicator, selection border, window

The Part view window colors can be changed.



**NOTE**

The probe indicator is enabled by clicking the View/Show position indicator menu item.

The default colors are:

- Window: White
- Parent: Orange
- Probe indicator: Blue
- Border: Blue

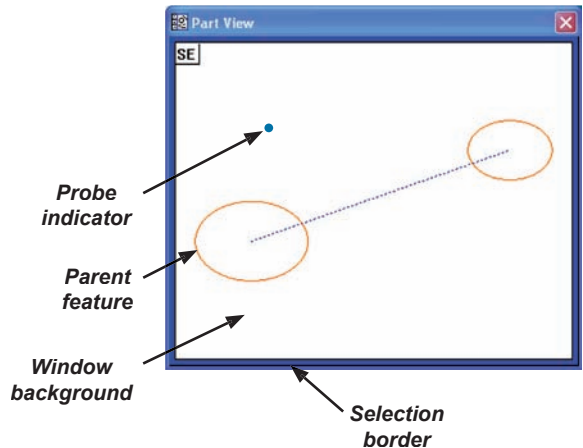

## Profile background

The background color of the Measure Profile window can be changed.

The default color of the background is white.

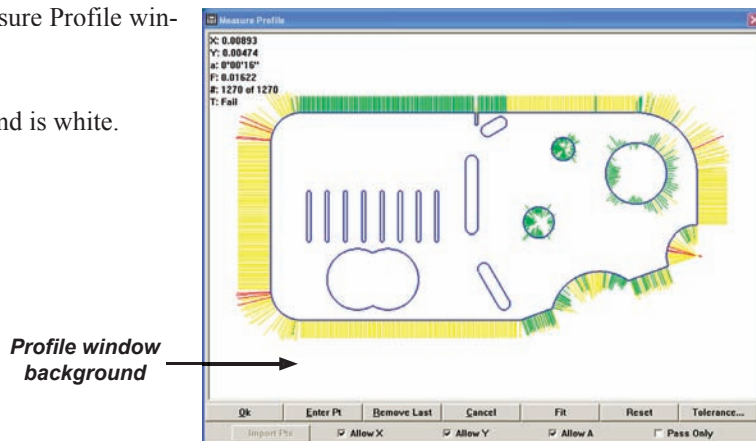

## Form error whiskers

During profile measurements, shapes are measured and compared to nominal profiles. The differences between actual and nominal data generate form errors inside and outside material surfaces. The default colors of whiskers are:

- |  |        |
|--|--------|
| • Failed inside:                       | Red    |
| • Failed outside:                      | Red    |
| • Passed inside 0-50% of tolerance:    | Green  |
| • Passed inside 50-100% of tolerance:  | Yellow |
| • Passed outside 0-50% of tolerance:   | Green  |
| • Passed outside 50-100% of tolerance: | Yellow |

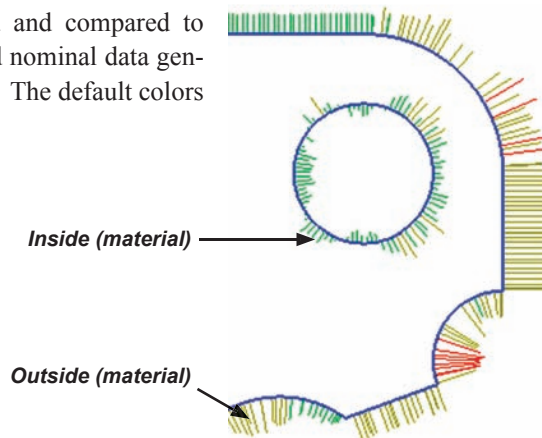

# Specifying on-screen help tips

In addition to the electronic version of this User's Guide, help is available in the form of on-screen tips for:

- Menus (tips for menus appear in the status bar)
- Toolbars
- Status bar
- Results window

Click the Tools/Customize/Help menu item to display the Help screen.



Toolbar tip

Statusbar tip

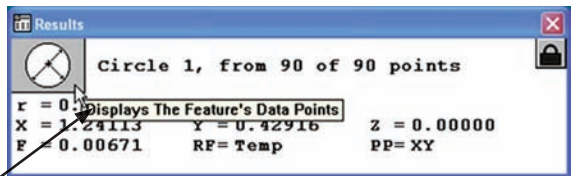
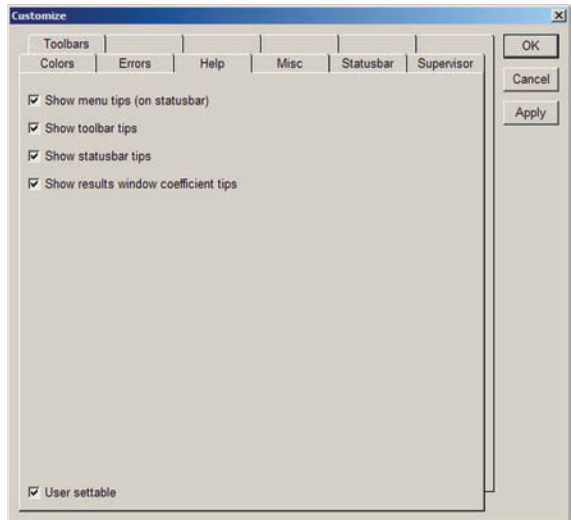

Results window tip

Check the desired box(s) on the Help screen to show tips for the associated item(s).

All tooltips are shown by default.



Tips for highlighted menu items appear in the statusbar

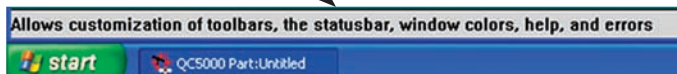



## Specifying error messages

Error messages can be displayed that describe most system errors. These messages are specified in the Errors screen and listed below.

All errors are enabled for display by default. Any of these error messages can be disabled by clearing their check boxes. All error messages can be disabled simultaneously by checking the Disable all system error messages box.



### CAUTION

**Disabling error messages can hide error conditions that produce faulty measurement data. Do not disable error messages unless you fully understand the consequences.**

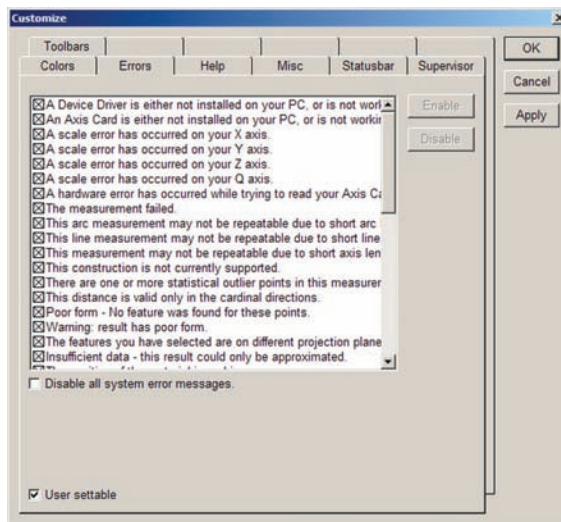

Click the Tools/Customize/Errors menu item to display the Errors screen.



### NOTE

**The error messages are not necessarily listed here in their order of appearance in the Error screen list box.**

## System error messages

- Temperature Compensation should be disabled before doing any kind of Teach or Calibration.
- NC control off.
- A Device Driver is either not installed on your PC, or is not working properly. Because of this, the Axis Cards will not work.
- An Axis Card is either not installed on your PC, or is not working properly. Because of this the DRO will not work, and measurements can only be probed using the Demo Stage (located under the Windows menu).
- A scale error has occurred on your X axis.
- A scale error has occurred on your Y axis.
- A scale error has occurred on your Z axis.
- A scale error has occurred on your Q axis.
- A hardware error has occurred while trying to read your Axis Card.

- The measurement failed.
- This arc measurement may not be repeatable due to short arc length.
- This line measurement may not be repeatable due to short line length.
- This measurement may not be repeatable due to short axis length.
- This construction is not currently supported.
- There are one or more statistical outlier points in this measurement.
- This distance is valid only in the cardinal directions.
- Poor form - No feature was found for these points.
- Warning: result has poor form.
- Insufficient data - this result could only be approximated.
- The position of the material is ambiguous.
- The result is out of range.
- There is no intersection between these features.
- The points probed in Measure Magic do not make a good enough feature of that type.
- Datum Magic could not complete successfully because an invalid feature type was measured.
- Please use the blob probe for this measurement
- Cannot complete programmed move
- You can't use the crosshair probe while using Measure Magic or Datum Magic.
- The magnification that you are in has not been calibrated.
- The points that are about to be entered into the measurement may be invalid.
- Sorry, but motors are currently turned off.
- A following error has occurred on your X axis.
- NC control off
- A following error has occurred on your Y axis.
- A following error has occurred on your Z axis.
- A following error has occurred on your Q axis.
- A limit switch on the X axis has been hit!
- A limit switch on the Y axis has been hit!
- A limit switch on the Z axis has been hit!
- A limit switch on the Q axis has been hit!

## Specifying status bar information

The status bar extends across the bottom of the QC5200 screen.



The status bar can be customized to display a variety of system and measurement status information by checking or clearing boxes in the Statusbar screen.

Click the Tools/Customize/Statusbar menu item to display the Statusbar screen.

To display information in the status bar, highlight the desired item and click Show.

Information can be displayed in the status bar from left to right, or from right to left. Click the Display items from left to right box for left to right presentations.

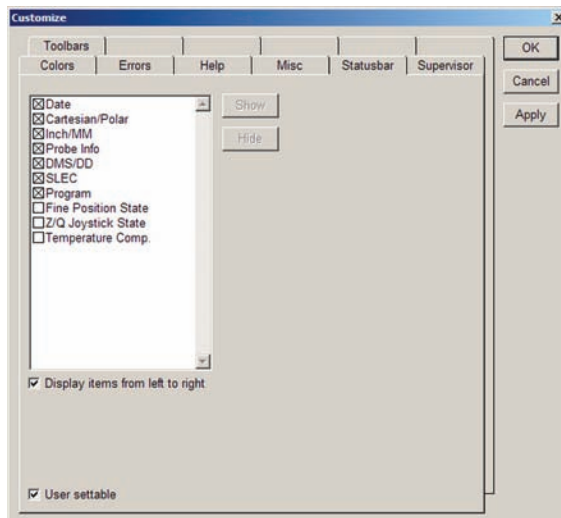

The default status of the status bar depends on system configuration settings.

# Customizing toolbars

Toolbars can be customized to facilitate measurement, programming, file and other activities using functions provided by the Toolbars screen.

Click the Tools/Customize/Toolbars menu item to display the Toolbars screen.

Toolbars are shown or hidden by checking or clearing boxes contained in the View/Toolbars screen. All QC5200 toolbars are shown in alphabetic order in the Toolbars list-box of the Toolbars screen.

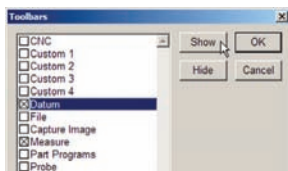

## Displaying current toolbar buttons

Click a toolbar name in the Toolbars listbox to display its contents in the Buttons in Toolbar listbox.

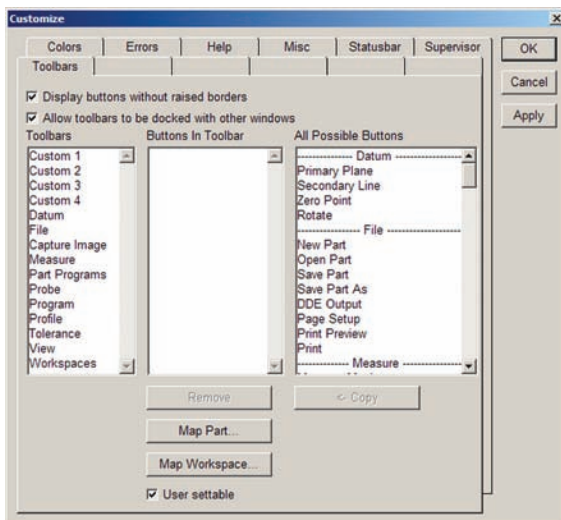

## Adding buttons to a toolbar

To add a button to a toolbar:

- 1 Click a toolbar name in the Toolbars listbox, then scroll to the matching toolbar button group in the All possible buttons listbox.

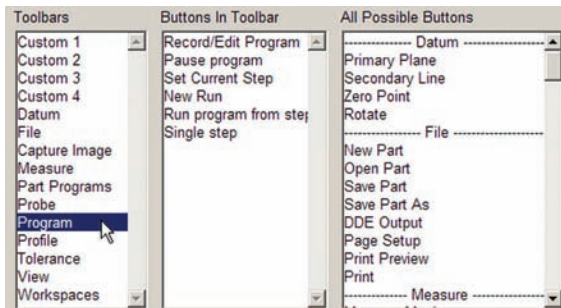
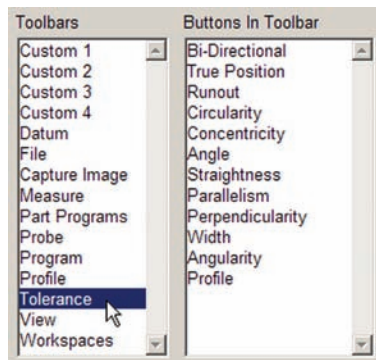

2 Click the desired button name and click Copy.

The new button will be shown in the middle Buttons in Toolbar listbox and added to the toolbar.

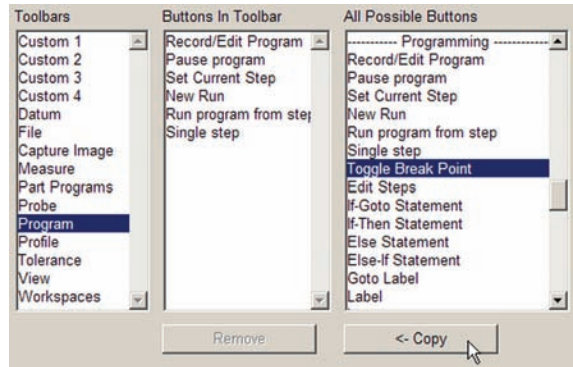

## Removing buttons from a toolbar

To remove a button from a toolbar:

1 Click the toolbar name in the Toolbars listbox, click the button you wish to remove and then click the Remove button.

The button will be removed from the Buttons in Toolbar listbox and from the toolbar.

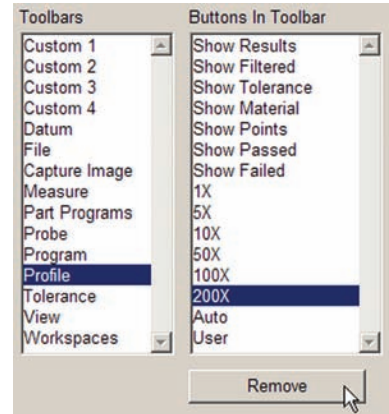

## Enabling or disabling raised edges for toolbar buttons

Toolbar buttons can be displayed with or without raised button edges.



*Raised buttons enabled*



*Raised buttons disabled*

Check or clear the Display buttons without raised edges box as desired.

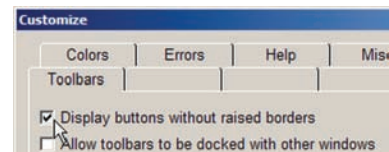

## Allowing or prohibiting toolbar docking

Toolbars can be docked to the inside edges of QC5200 windows. Check or clear the Allow toolbars... box as desired.

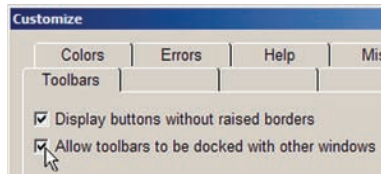

Toolbar not docked

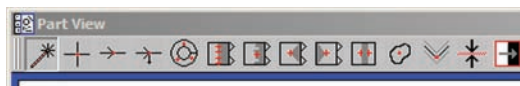

Toolbar docked

## Mapping parts to a toolbar

Parts can be mapped to toolbar buttons when more structured or automated operator environments are required. To map a part to a toolbar:

- 1 Click the toolbar that will include the new part button.
- 2 Click the Map Part button. The Map Part to Button file dialog box will be displayed.
- 3 Click the file name of the desired part and click Open.

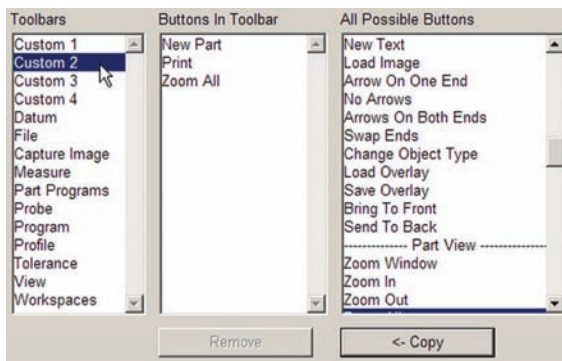

You will be asked if you wish to have the part's program run automatically when the button is pressed. Click Yes or No as desired.

The new part button will appear in the Buttons in Toolbar list.

- 4 Click OK. The new part button will be displayed in the toolbar.

- 5 The current workspace was changed when the new button was added, and now must be saved. Click View/ Workspaces/Save workspace as... and save the workspace under an existing or a new file name.

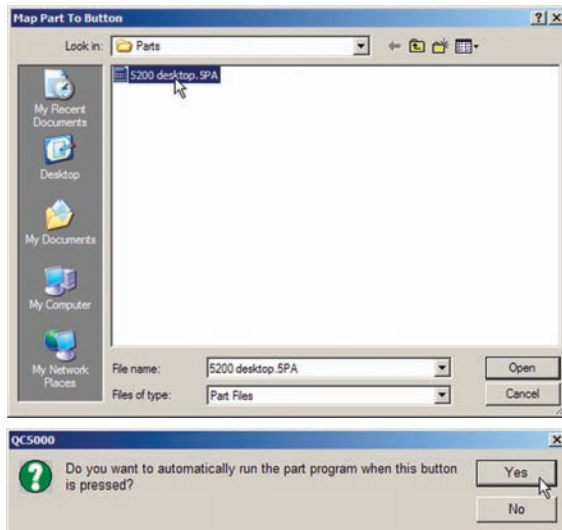

## Mapping workspaces to toolbar

Workspaces can be mapped to toolbar buttons to simplify and speed the process of changing operators. To map a workspace to a toolbar:

- 1 Click the toolbar that will include the new workspace button.
- 2 Click Map Workspace. The Map Button to Workspace file dialog box will be displayed.

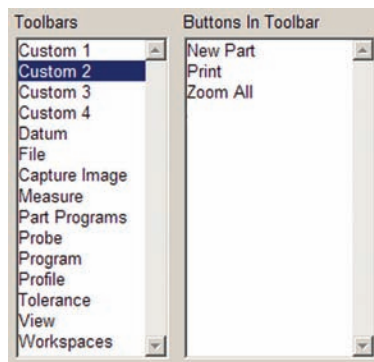
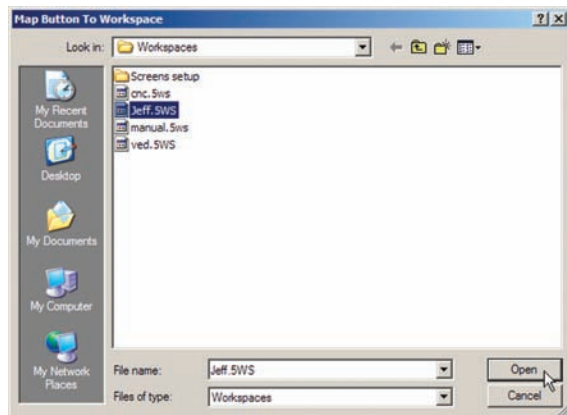

- 3 Click the file name of the desired workspace and click Open.
- 4 The new button will appear in the Buttons in Toolbar listbox. Click OK. The new workspace button will be displayed in the toolbar.

- 5 The current workspace was changed when the new button was added, and now must be saved.

Click View/Workspaces/Save workspace as... and save the workspace under an existing or a new file name.

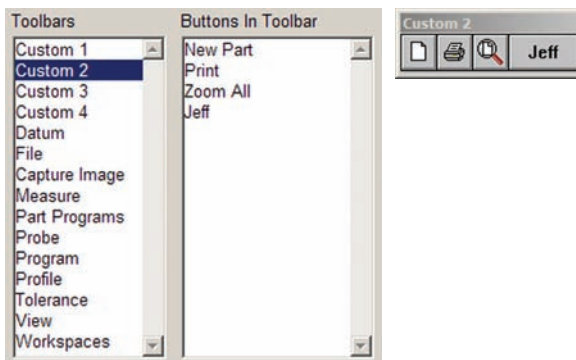

## Creating custom toolbars

Custom toolbars can be created to include any combination of buttons that organize measurement functions, parts, workspaces and other elements of the QC5200 operating environment. Up to four custom toolbars can be constructed to provide unique work environments that satisfy specific operator and application requirements. To create a custom toolbar:

1 Click one of the four custom toolbars in the Toolbars listbox.



**NOTE**  
If the custom toolbar contains buttons already, it might be necessary to select another custom toolbar or to remove the existing buttons.

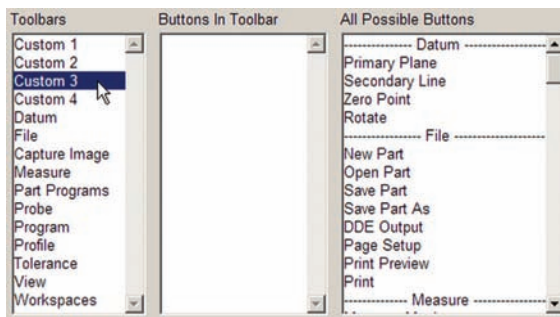

2 Add any desired buttons from the All possible buttons listbox, and map parts or workspaces to buttons if desired.

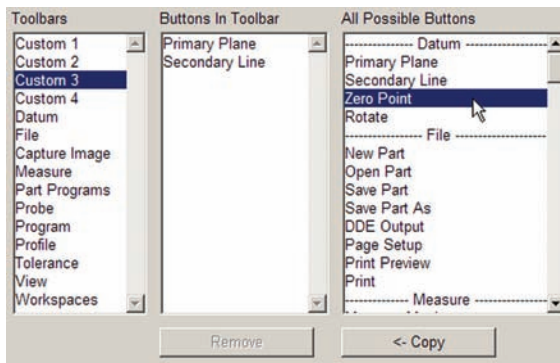

3 Show the new custom toolbar by highlighting it in the View/Toolbars listbox and clicking Show.

The new toolbar will be displayed.

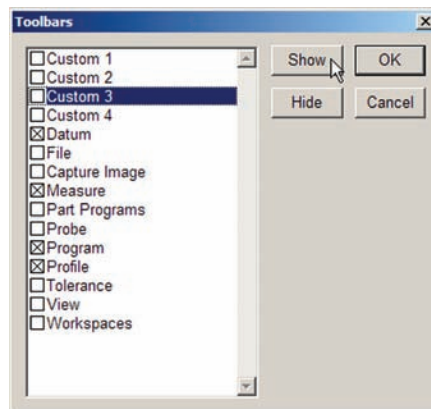



## Setting up programming parameters

Many facets of program recording and execution can be configured using tools provided in the Programming screen.

Click the Tools/Options/Programming menu item to display the Programming screen.

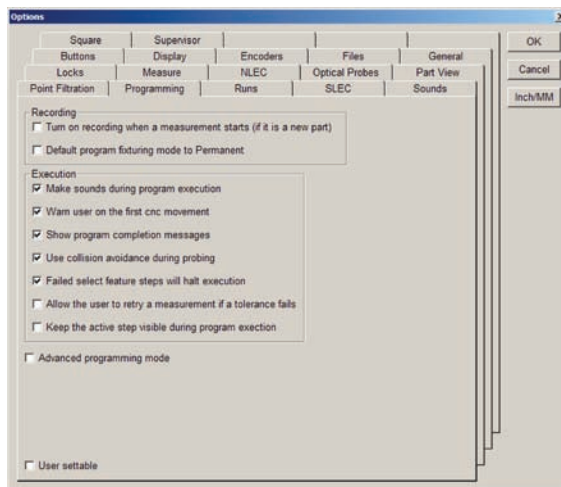

## Starting program recording automatically

Programming recording can be started automatically when the first part measurement is made. This can make programming more efficient by eliminating the wasted time when starting programming on a new part is overlooked.

Check the Turn on recording... box to enable automatic programming on each new part.



## Specifying permanent fixturing as the system default

The properties of each program include one of three possible fixturing modes: None, Temporary and Permanent. Each fixturing mode requires different datum activities when the program is executed:

- None: No fixture is used, a part datum must be created each time the program is executed.
- Temporary: A temporary fixture is used, a part datum must be created the first time a series of executions is run.
- Permanent: A permanent fixture is used, the part datum is assumed to be constant. It is not necessary to create a part datum.

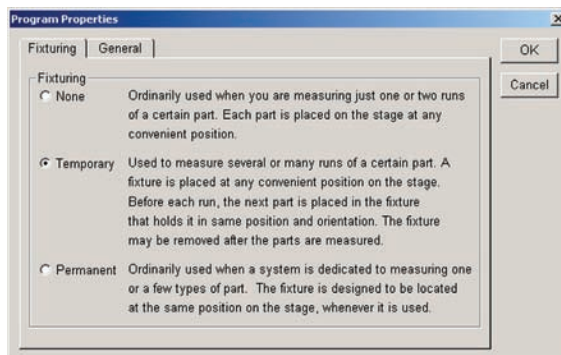

**NOTE**

The fixturing mode of each program can be changed from the default mode in the Program Properties window.

The default fixturing mode for all programs can quickly be set to Permanent in the Programming Options screen.

Click the Default programming fixturing... box to set the default program fixturing to Permanent. Clear the box to set the default fixturing to Temporary.



## Enabling sounds during program execution

System sounds configured in the Sounds Options screen alert the operator to various conditions during program execution. These sounds can be enabled or disabled in the Programming Options screen. The generation of sounds can slow program execution.

Click the Make sounds... box to enable sounds during program execution.



## Specifying CNC movement warnings

Users can be warned prior to the first CNC movement executed by a program as a means of avoiding probe collisions. Enabling this warning function is strongly recommended.

Click the Warn user on the first CNC movement box to enable warnings.



## Showing program complete messages

Check the Show program completion messages box to display the program complete message each time a program execution is complete.

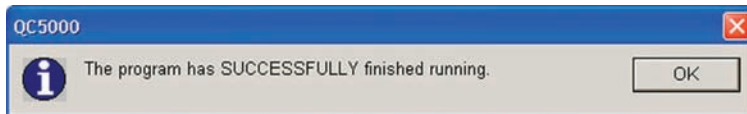

## Halting execution for failure to select features

Feature constructions recorded in programs require the successful selection of parent features. Under certain circumstances, it is possible that one or more parent features will be missing due to feature measurement irregularities. Program execution can automatically be halted if a parent feature is missing from a construction to avoid new feature construction inaccuracies and omissions.

Check the Failed select features... box to halt program execution when one or more features required for a new feature construction are missing. Clear this box if you wish to complete all program steps even when all features were not measured.

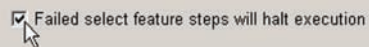

## Specifying retries on tolerance failures

By default, when a tolerance measurement fails, program execution continues. Checking the Allow the user to retry... box causes a message to prompt the user for interaction when a tolerance measurement fails. The choice of actions is:



- Try the measurement again automatically
- Try the measurement again manually, allowing the user to adjust video position
- Continue executing the program in spite of a tolerance measurement failure

## Displaying active program steps during execution

By default, to maximize program execution efficiency, active program steps are not shown in the Program Template while a programs are executed. However, active steps can be shown for the purposes of program debugging by checking the Keep the active step visible... box.

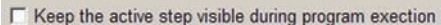

### NOTE

Displaying the active step during program execution slows program execution.

## Enabling the advanced programming mode

By default, the QC5200 basic programming functions are enabled. The basic programming functions include everything necessary to automate the vast majority of measurement applications. Advanced functions can be enabled by checking the Advanced programming mode box.

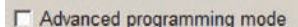

### CAUTION

Advanced programming functions are intended only for experienced programmers who must create unique system behavior to satisfy the requirements of special applications and should only be enabled when absolutely essential.

## Specifying the maximum program executions

Use the Runs screen to specify the maximum number of program executions (runs) to be displayed in the Runs template.

As the number of runs increases, the amount of system memory available for processing and storage decreases. This can eventually degrade QC5200 program performance as the number of runs grows large.



### NOTE

**If the number of runs displayed in the Runs template exceeds the Max Runs setting, the oldest run data will be deleted as new runs are added. Regular backups of the Runs data are recommended.**

Click the Tools/Options/Runs menu item to display the Runs screen.

Enter the desired number of runs to be displayed into the Max runs field.

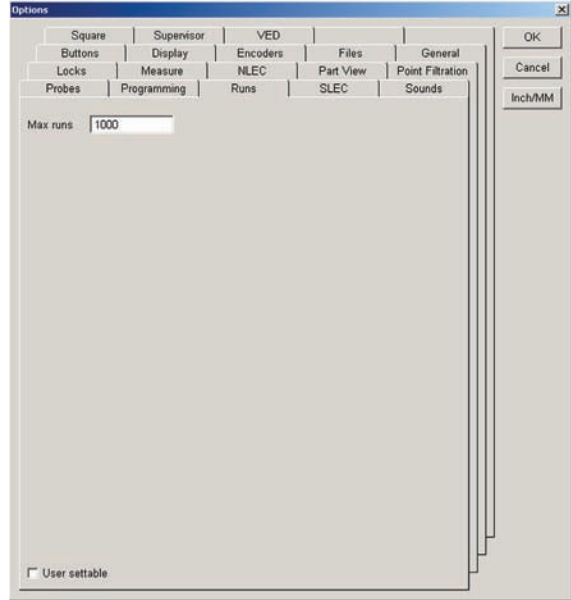

## Restricting access to setup screens

Use the Locks screen to lock display and setup parameters in order to prevent unintended or unauthorized changes.

Click the Tools/Options/Locks menu item to display the locks screen.



### NOTE

The locks option screen is accessible only to individuals that can provide the correct supervisor password.

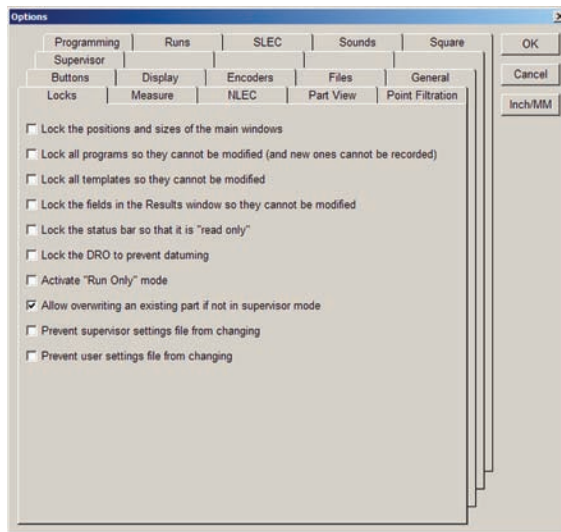

### ***Locking window position and size***

Check the Lock positions... box to prevent changes in the display window position and size.

### ***Locking programming functions***

Check the Lock all programs... box to prevent changes to existing programs, and to prevent the creation of new programs.

### ***Locking template functions***

Check the Lock all templates... box to prevent changes to existing templates, and to prevent the creation of new templates.

### ***Locking results window contents***

Check the Lock the fields... box to prevent changes to the contents of the results window. This also prevents dragging results from the results window into a template window.

### ***Locking the status bar contents***

Check the Lock the status bar... box to prevent system changes from the status bar.

### ***Locking the DRO datuming***

Check the Lock the DRO... box to prevent zeroing an axis datum.

### ***Locking the run mode in program execution***

Check the Activate "Run Only" mode box to limit QC5200 activities to only running existing programs.

### ***Locking part files***

Leave the Allow overwriting box unchecked to prevent non-supervisory personnel from saving new part files using existing part file names.

### ***Locking supervisor settings***

Check the Prevent supervisor... box to prevent changes to the configuration settings made by supervisory personnel in the Tools Custom, Tools Options and Tools CNC screens.

### ***Locking user settings***

Check the Prevent user settings... box to prevent changes to the configuration settings made by non-supervisory personnel in the Tools Customize, Tools Options and Tools CNC screens.

## Configuring measurement parameters

Use the Measure screen to configure the display, the number of data points and other parameters governing QC5200 measurements.

Click the Tools/Options/Measure menu item to display the Measure screen.

### Specifying feature display defaults

Features can be displayed in the Part window as solid lines as dashed lines, or can be hidden. Displayed features can also include the names that appear in the results window.

#### Feature types

Four types of features are displayed:

- Features that are probed
- Features that are relations of two other existing features (angles and distances)
- Features that are constructed of other existing features
- Features created by entering data

#### Display of feature types

Each of the four feature types described above can be assigned the display default of:

- Phantom  
Shown in the Part view window as a dotted line
- Hidden  
Not shown in the Part view window unless highlighted in the features list
- Show name  
The feature name will be shown in the Part view window next to the feature

### Starting Measure Magic automatically

Measure Magic can be configured to start automatically when a tool is fired and no measure prompt is displayed. This function can increase throughput on manual systems. Check the Start Measure Magic... box to automatically start Measure Magic.

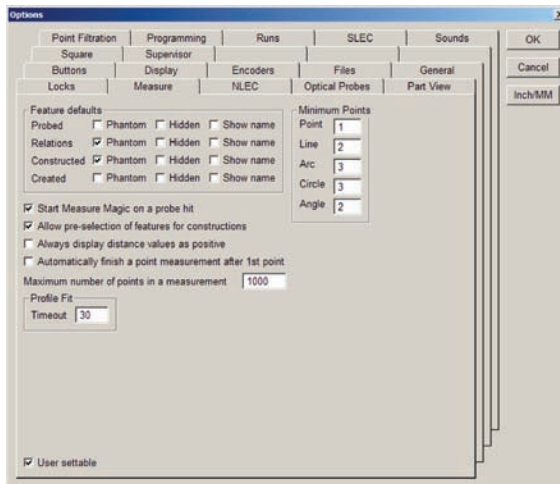

## Pre-selecting features for a construction

Two methods can be used to construct features:

### Method 1

- Click a measure tool
- Select existing features
- Click measure OK

### Method 2

- Select existing features
- Click a measure tool
- Click measure OK

The required steps and resulting constructions are the same in either case. However, the order of steps can be specified to suit the preferences of the user. Check the Allow pre-selection... box to select features before choosing a measure tool.

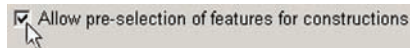

## Displaying distances as absolute values

Distance values can be positive or negative depending on the locations of features selected for distance constructions, and on the order of selection. However, the system can be configured to display the absolute values (always positive) of distances regardless of feature location and selection order. Check the Always display distance... box to display distances as positive values.



## Automatically complete point measurements

Normally, point measurements are completed by clicking OK in the Feature measure dialog box after probing the point. This last step can be eliminated for point measurements. Check the Automatically finish a point measurements... box to automatically complete point measurements.



## Specifying the maximum number of measurement points

Each probe can be configured collect a specific maximum number of points when it's fired. These points accumulate as a probe is repeatedly fired during a feature measurement. The system can be configured to collect up to 3000 points for an entire feature measurement. Enter the maximum number of points for a complete feature measurement into the Maximum number... data field.

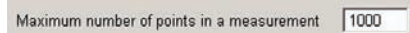

## Specifying the minimum number of measurement points

The feature fitting algorithms require a minimum number of probed points to determine each feature type's location and size. The default values shown in the Minimum Points data fields reflect these minimums. However, the system can be forced to require a greater minimum number of points to increase the measurement accuracy when the minimum number of points is probed. Enter the desired values into the fields provided.

| Minimum Points |   |
|----------------|---|
| Point          | 1 |
| Line           | 2 |
| Arc            | 3 |
| Circle         | 3 |
| Angle          | 2 |



## Displaying parts and probe position

Use the part view screen to configure the default displays of parts, video probes and touch probes. The default pixel size of constructed points and feature selection zones are also configured in the part view screen.

Click the Tools/Options/Part View menu item to display the Part View screen.

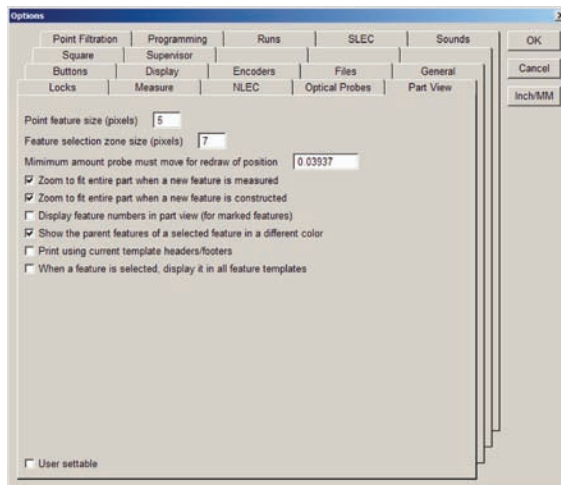

### Specifying the point feature size

The default point feature size shown in the Part View window during program execution can be specified in pixels. Enter the desired pixel size for displaying point features into the Point feature size (pixels) field.



### Specifying feature selection zones size

The feature selection zone is the circular area around the tip of the arrow cursor. Features are recognized by the QC5200 system only within this area. Increasing the diameter of the selection zone makes feature selection less sensitive, but increases the danger of accidentally selecting multiple features. Decreasing the diameter of the selection zone reduces the danger of accidentally selecting multiple features, but increases the difficulty of selecting an individual feature.

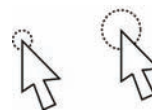

Enter the desired selection zone size into the Feature selection... data field.



**NOTE**

The default 7 pixel diameter strikes an excellent balance of sensitivity and ease of operation, and should be retained if possible.

## Specifying automatic redraw of part view

During program execution, the part view is periodically redrawn to show the probe position changing as features are measured. The part view is redrawn each time the probe moves the distance specified in the data field. Change the redraw rate by entering a new value into the Minimum amount... field.

Minimum amount probe must move for redraw of position

## Zooming to view whole part on measurements

Check the Zooming to fit... box to zoom to display the entire part when a feature is measured or created.

Zoom to fit entire part when a new feature is measured

## Zooming to view whole part on constructions

Check the Zoom to fit... box to zoom to display the entire part when a feature is constructed.

Zoom to fit entire part when a new feature is constructed

## Displaying feature numbers and names on part views

Feature properties and the part view options screen can be configured to show only features with numbers or features with numbers and names of selected features.

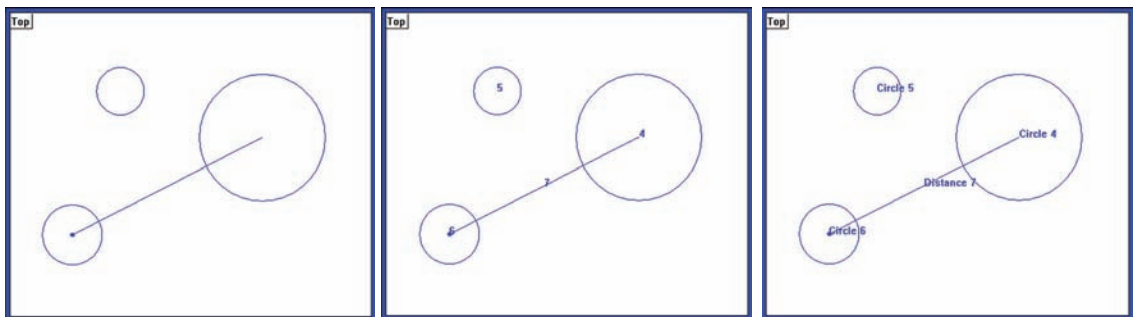

When feature properties are configured to show names, the Part View options screen can be set to show numbers or numbers and names on the part view screen.

## Displaying only features

To display selected features without numbers or names on the part view screen:

1 Close the Part View Options screen, highlight and right-click the desired features, and then click Feature Properties. The Feature Properties window will be displayed.

2 Clear the Show Name box, and then click OK.

Only the selected features will be shown on the part view screen, without numbers or names, regardless of settings in the Part View options screen.

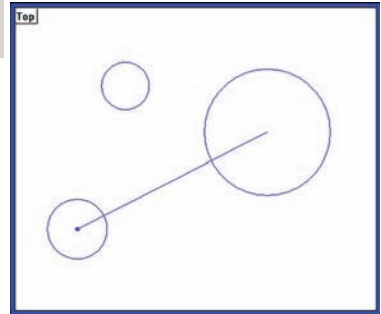
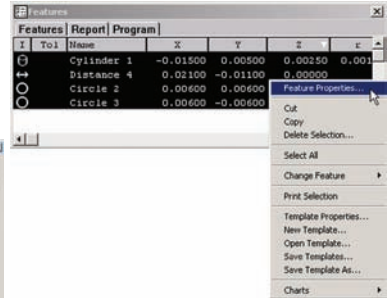
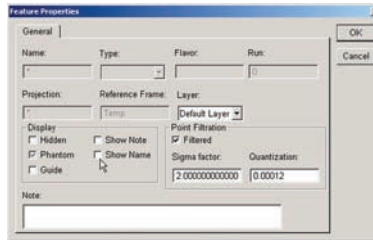

## Displaying features with numbers

To display selected features with numbers on the part view screen:

1 Close the Part View Options screen, highlight and right-click the desired features, and then click Features Properties. The Feature Properties window will be displayed.

2 Check the Show Name box and then click OK.

3 Reopen the Part View Options screen and check the Display a feature numbers... box.

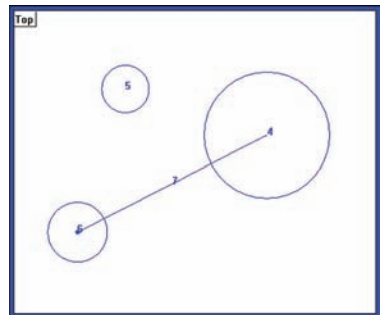
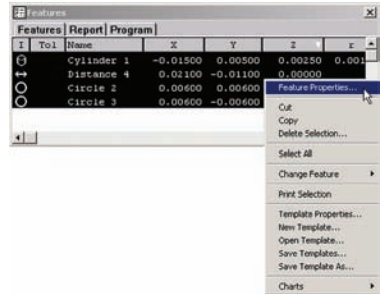
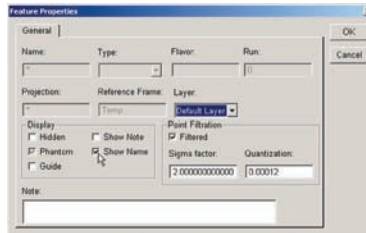

Display feature numbers in part view (for marked features)

Selected features will be displayed with a feature numbers on the Part View screen.

### Displaying features with numbers and names

To display selected features with numbers and names on the part view screen:

1 Close the Part View Options screen, highlight and right-click the desired features, and then click Feature Properties. The Feature Properties window will be displayed.

2 Check the Show Name box, and then click OK.

3 Reopen the Part View Options screen and clear the Display Feature numbers... box.

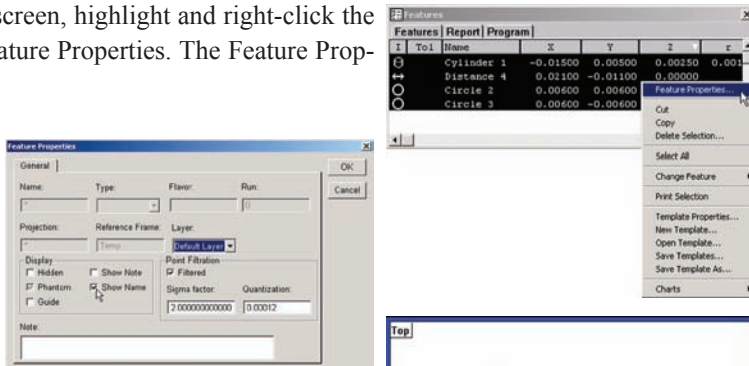

Selected features will be displayed with feature numbers and names on the Part View screen.

### Showing parents of constructed features in a different color

Parent features, used to construct new features, can be highlighted on the Part View screen using a different color.

To highlight parent features, check the Show the parent features... box to show parent features in a different color.



**NOTE**  
The color used to display parent features in specified in the Tools/Customize/Colors screen.

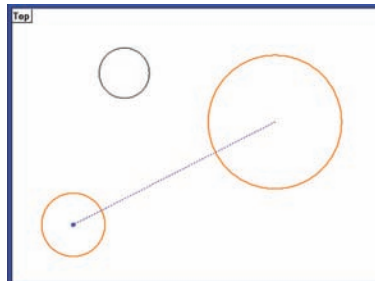

The parent circles of the constructed distance feature are shown in a different color

## Specifying the headers and footers for part view printing

Part views can be printed using headers and footers from any active report template by checking the Print using current... box.

Print using current template headers/footers

This feature makes it possible to develop different report templates to fill the needs of different audiences, and then simply select the desired template prior to printing the part view.

When printing a part view, click on the desired template to use its header and footer, then click on Print Part View.

## Displaying a feature in all templates

A selected feature can be displayed in all templates by checking the When a feature is selected... box.

When a feature is selected, display it in all feature templates

When this feature is used, any feature selected in the part view window will also be displayed in all templates. Templates will be scrolled if necessary to display the feature.

## Configuring joystick and footswitch buttons

Use the Buttons screen in systems that include CNC functions to assign frequently used QC5200 system functions to joystick and optional foot switch buttons. Using preassigned buttons saves the time normally required to navigate menus to invoke frequently used functions.

Click the Tools/Options/Buttons menu item to display the Buttons screen.

Each of the joystick and foot switch buttons can be assigned to 1 of 14 QC5200 system functions in the Buttons screen. Thereafter, pressing the button invokes the assigned function.



### Level-based button functions

Many button functions are invoked only once when the button is pressed. Others can be configured to be momentary (level-based) or to toggle functions on or off. Momentary functions are active only while the button is pressed and held. Toggle functions are activated when the button is pressed and deactivated when the button is pressed again.

#### ***Button functions that are invoked only once***

Button functions that are invoked only once when the button is pressed include:

- Measure: OK
- Measure: Enter pt
- Measure: Remove last
- Measure: Cancel
- View from probe
- Go to here
- Pause program
- Run program

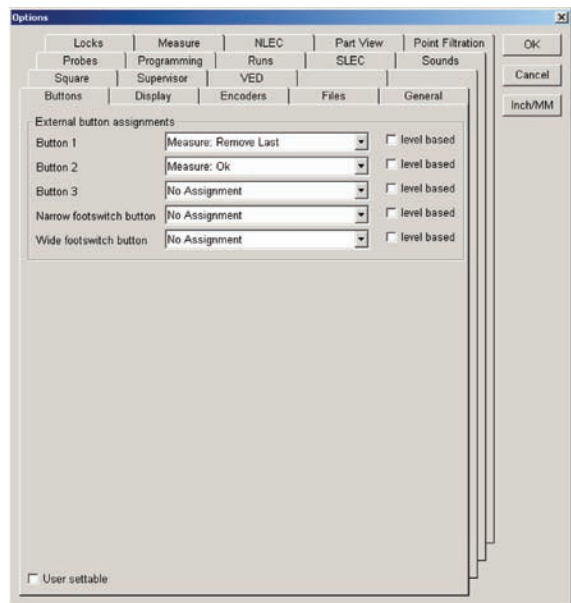

#### **NOTE**

None of the eight button functions listed above can be configured as momentary (level-based).

## **Button functions that can be momentary or toggled**

Buttons that are active while pressed and held, or toggled on and off include:

- Axis lock
- Speed toggle
- Motors off
- Swap Z joystick
- Swap Z digital positioner
- Swap Q joystick

## **Button functions**

Descriptions of the functions are provided in the following paragraphs:

### **No assignment**

Pressing the button causes no action

### **Feature measure functions**

The functions below duplicate those shown on Feature measure dialog boxes.

- Measure: OK
- Measure: Enter pt
- Measure: Remove last
- Measure: Cancel

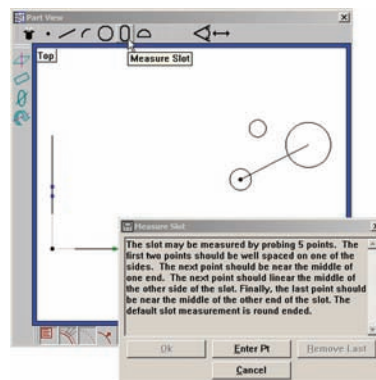

**Feature measure functions**

### **Axis lock**

Pressing the button toggles the Axis Lock function on or off. When Axis lock is toggled on, motion is permitted on only one Axis at a time; diagonal motion is not permitted. This function duplicates the Axis Lock found in the Joystick Tools menu.

### **Motors off**

Pressing the button toggles all Axis motors on or off. This the Motors Off found in the Tools menu.

### **Speed toggle**

Pressing the button toggles all Axis motor speeds between fast and slow.



#### **NOTE**

**Axis motor speeds are defined in the CNC Tools screen.**

### **Motors off**

Pressing the button toggles all Axis motors on or off. This function duplicates the Motors Off found in the Tools menu.

### **Swap Z joystick**

Pressing the button toggles the vertical joystick motion between the Y-axis and the Z-axis.

### **Swap Z digital positioner**

Pressing the button toggles the vertical trackball motion between the Y-axis and the Z-axis.

### **Swap Q joystick**

Pressing the button toggles the vertical joystick motion between the Y-axis and the rotary Q-axis.

### **Go to here**

Pressing the button inserts a Goto Here step into the current line of the program being recorded. This function duplicates the Goto Here found on the program toolbar.

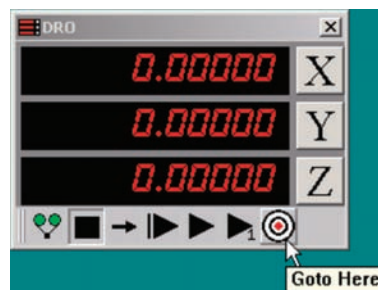

### **Pause prg**

Pressing the button pauses the current program execution. This function duplicates the Pause found on the program toolbar.

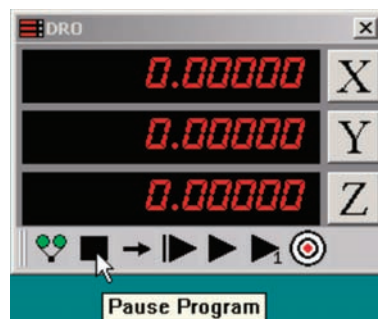

### **Run prg**

Pressing the button runs the current program starting from the current step, and is typically used to resume program execution after a pause. This function duplicates the Run Program From Current Step found on the program toolbar.

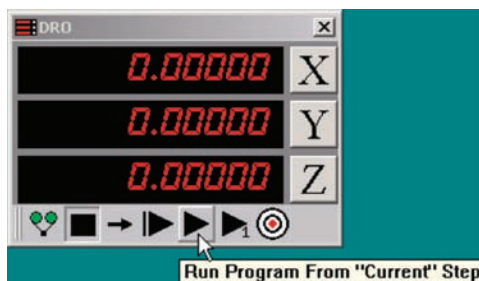



## Setting the display of resolution, time and date

Use the display screen to specify the display resolution of linear and angular values, and to format the display of time, date and angles.

Click the Tools/Options/Display menu item to display the Display screen.

### Specifying display resolution

Enter the display resolutions for linear and angular values into the appropriate Display Resolution fields. Metric values are expressed in millimeters.

Display resolutions that exceed the resolution of the input encoders result in unnecessary zeros at the right of the displayed value. Display resolutions less than the resolution of input encoders result in the display of rounded values.

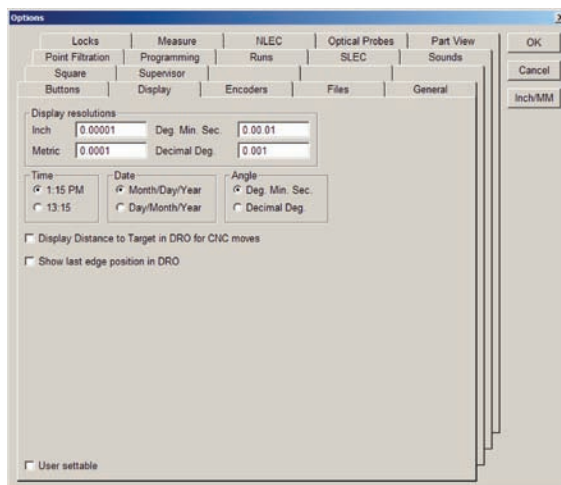

### Formatting time, date and angles

Format the display of time, date and angles by clicking the desired radio button.

### Displaying the distance to target surfaces for CNC moves

Normally, the DRO displays the current input sensor position. Checking the Display distance to target... box changes the DRO to display the distance to the next CNC target while running a program. This can be useful when debugging a program.

The distance decreases during CNC moves until the continuation zone around the CNC target point is reached. At that time, the DRO displays the current position until the measurement at the target is complete. When the measurement is complete, the DRO changes to display the distance to the next CNC target again. When the program is completed or halted, the DRO displays the current position until the next program execution begins.



### Showing the last edge position in the DRO

Check the Show last edge... box to show the position of the last edge detected by the optical edge detection system in the DRO numeric readout.

Show last edge position in DRO

## Specifying encoder parameters

Use the encoder screen to specify encoder resolution, units of measure, count direction and reference mark type.

Click the Tools/Options/Encoders menu item to display the Encoders screen.

### Specifying encoder resolution

Enter the resolution specification of the encoders used with your system into the X, Y and Z Resolution fields.

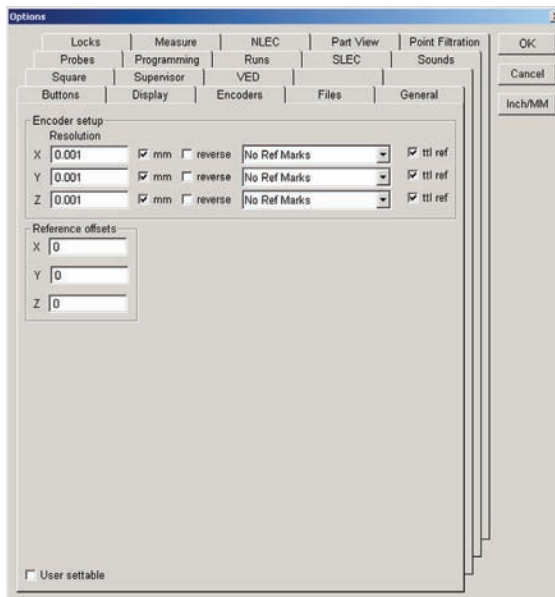
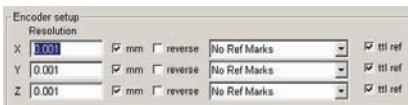

### Specifying encoder unit of measure

Check the mm box for metric encoders, or clear the mm box for encoder output values in inches.

### Specifying encoder count direction

Check or clear the reverse boxes to achieve the desired DRO count directions.

### Specifying encoder reference marks

Highlight the desired reference mark type in the drop-down lists, and then clear the TTL Ref box for analog reference marks.

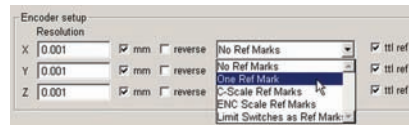

### Reference offsets

The Reference offsets fields are used by OEM setup personnel and qualified service technicians to move the location of the system's machine zero.



#### CAUTION

The machine zero location must be undisturbed to ensure correct operation and accurate error correction. Do not change to reference offsets values.

## Specifying file names, locations and backups

Use the files screen to specify QC5200 system file locations, methods of automatic file saving, file name display and automatic file backup interval.

Click the Tools/Options/Files menu item to display the Files screen.

### Specifying file locations

The default storage location for files is:

C:\QC5000

The storage location for any file can be changed by selecting a new location using the Browse tool.



#### CAUTION

Storing files in the QC5000 directory is recommended. Storing

files in other directories or on other drives can lead to lost files and program execution problems. Never store files on network drives. Network priorities and timing requirements can cause program execution problems when writing to or reading from network drives.

### A description of file types

The QC5200 file types are described below:

#### Backups

Automatic and manual QC5200 backup files contain QC5200 system and encoder configuration settings. A QC5200 installation can be completely restored from a backup file if necessary. The backup file extension is:

Filename.qb2



#### CAUTION

Templates and part files are not included in backup files and must be backed up separately. Save templates by right-clicking the template, save part files from the File menu.

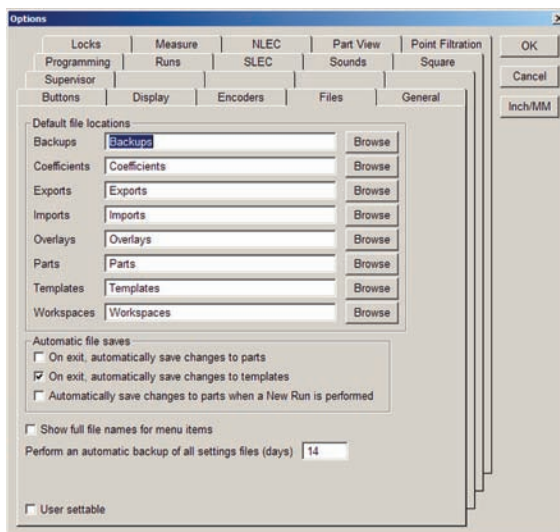

## Exports

Any feature(s) in the Feature list can be highlighted and exported as an export file. Export files can be drawing, database or delimited string files. Export file extensions include:

- .tdf
- .csv
- .dxf
- .igs

## Imports

Features can be imported to the Feature list and Part view from drawing files contained in the default imports directory or from other directories accessed by browsing. Imported files include geometric features and video charts. Import file extensions include:

### .dxf

The QC5200 supports a subset of this standard AutoCad file format, version 12. It can handle Points, Lines, Circles, Arcs, Poly Lines, and Splines.

### .igs

The QC5200 supports a subset of the “Initial Graphics Exchange Specifications” file format. It can handle Points, Lines, Arcs, Splines, and Nurbs.

### .asc

This is a simple text file of Point Features. The default format is:

```
x1 y1 z1
x2 y2 z2
x3 y3 z3
...
```

Each line of the file is a Point Feature, and specifies the x, y, and z position of the Point. Each line of the file is defined in Import[Data]Format as a scanf format string. This data item is located in the Import.met file and could be changed if necessary to take into account commas or other characters.

### .sac

This is a simple text file of Circle Features. It can have one of 2 formats.

|  |   |
|--|---|
| <p>The first format is:</p> <pre>CI x1, y1, z1 CI x2, y2, z2 CI x3, y3, z3 ...</pre> | <p>The second format is:</p> <pre>C1 x1, y1, z1 C2 x2, y2, z2 C3 x3, y3, z3 ...</pre> |
|--|---|

Each line of the file is a Circle Feature, and specifies the x, y, and z position of the Circle. The CI or Cn is ignored by the QC5200.

**.tap**

This is a text file of Circle Features (“Holes”). It can be created by CAD programs to describe positions of holes on a circuit board. The format is:

```
%
T2C0.0140F200S100
X-001400Y027650
X-001060Y006740
...
T1C0.0100F200S100
X-001100Y012825
...
```

The % is ignored by the QC5200. The lines in the file beginning with X define the xy position of the Hole. The values are in microns (eg: -001400 is 1.4 mm). The lines in the file beginning with T define the diameter for each of the Holes that following the T line, until the next T is encountered. The diameter size begins after the C and ends at the F.

**.drl**

This import option can consist of 1 or 2 text files. They both have the same file name, but one has a DRL extension and the other has a TOL extension. After the file prompt, the user is asked:

- Digits Before Decimal Point (for diameters and positions in both files)
- Units (of the positions in DRL file)
- Scale Factor (for diameters and positions in both files)

As an example of how numbers are interpreted: if Digits Before Decimal Point is 3, Units is metric, Scale Factor is 1000, and the numeric string “12345”, the number used by the QC5200 would be:

$$123.45 / 1000 = 0.12345 \text{ mm.}$$

The DRL file is always required, and its format is:

```
%
T01
X18165Y1342
X18375Y14
...
```

The % is ignored by the QC5200. The lines of the file beginning with X define the xy position of the Hole. The lines of the file beginning with T define the diameter of holes for each of the Holes that following the T line, until the next T is encountered. The number immediately after the T refers to an hole size identifier in the TOL file. If there is no TOL file, or if the identifier cannot be found, the user is prompted to enter in the hole diameter.

The TOL file defines hole sizes and uniquely identifies them. The format is:

```
-----
-----
-----
T1 00030
T2 01234
T3 00123
...
```

The 3 dashed lines are ignored by the QC5200. The number immediately after the T is an identifier (label) for a hole size. The number immediately after the T identifier is the hole size, in metric units.

### **Overlays**

Templates can include page and report headers and footers. Headers and footers are created of text and graphic images, and are saved in the overlays folder to be recalled and added to pages or reports later. Overlay files have the following extension:

.5io

### **Parts**

Part files contain all aspects of a part including geometric features, part view and program. Part files have the following extension:

.5pa

### **Templates**

Template files can be created by the user to organize program, feature, report and other information into columns in the report window. Template files have the following extension:

.5ft

### **Workspaces**

Workspace files contain all aspects of the arrangement of user interface screens. These files can be recalled by different users to display the user interface in a manner that suits their individual needs. Workspace files do not include other QC5200 system settings and can be recalled without changing measurement or display parameters. Workspace files have the following extensions:

.5ws

## Saving part files automatically

Part and template files can automatically be saved upon exiting the program. Part files can also automatically be saved upon the completion of a program run. Check the desired Automatic File Saves box.

### Automatic file saves

- On exit, automatically save changes to parts
- On exit, automatically save changes to templates
- Automatically save changes to parts when a New Run is performed

## Showing full file names

File names displayed in menus can be shown in an abbreviated form, or can be displayed with complete file names and paths.



Check the Show full file names box to display complete file names and paths.

## Performing automatic backups

Backup files of QC5200 configuration settings can be saved automatically at an interval set by the user in the Perform an automatic backup... data field.

Enter the desired number of days between automatic backups directly into the Perform an automatic... data field.

Perform an automatic backup of all settings files (days)

## Setting serial port, machine zero and general parameters

Use the General screen to save QC5200 configuration settings, configure serial communication data, set machine zero or configure other general settings.

Click the Tools/Options/General menu item to display the General screen.

### User access to settings

Most QC5200 system settings are configured on the Customize, Options and CNC screens of the Tools menu.

User access to the tools on these screens is defined by the supervisor by checking the User settable box at the bottom-left of the configuration screens.



### Saving user access

The supervisor's user access settings are saved in the .5mp file at the root of the QC5000 directory.

To save the user settings immediately, click the Save now button.

To automatically save the user settings when the QC5200 program is closed, check the Save on exit box.



### Sending coefficient data to the serial port

Coefficients from the current results window can be sent to an RS-232 serial port of the user's choice whenever a new feature is measured. The user can also insert an ASCII delimiter between the coefficients and include coefficient labels in the data transmission.

To send coefficients:

- 1 Enter the desired COM port number for the RS-232 transmission of coefficient data into the COM# field. Verify that the specified COM port is not already reserved for some other purpose.

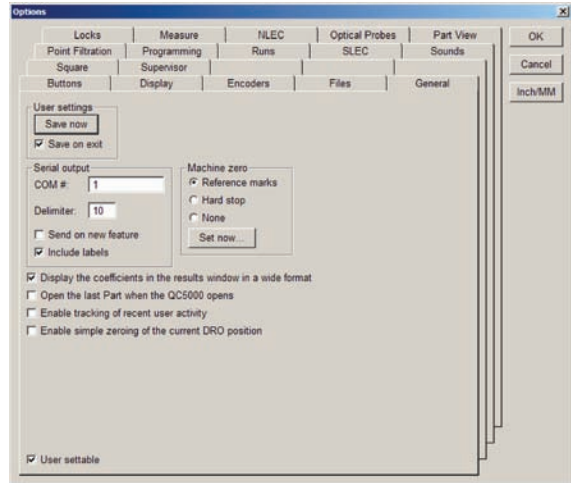
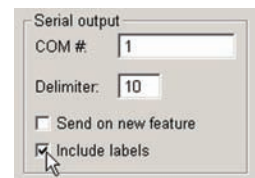



- 2 Enter the ASCII code of the delimiter used to separate coefficient data fields into the Delimiter field. A delimiter is required to separate data fields.

**NOTE**

A chart of ASCII codes is provided in [Appendix B: ASCII Codes](#).

- 3 Check the Send on new feature box to send coefficient data to the RS-232 port. Coefficient data will be sent from the results window each time a new feature is measured.
- 4 Check the Include labels box to transmit the result window's alpha labels with the numeric coefficient data. Without labels, the data is transmitted as a series of numeric data fields.

## Setting machine zero

The QC5200 machine zero can be specified and set at any time to facilitate set up, testing and encoder replacement.

To set machine zero:

- 1 Click the Reference marks, Hard stop or None radio box to specify the type of machine zero used.

**CAUTION**

The type of machine zero specified here should be consistent with the type specified on the Encoder Options screen.

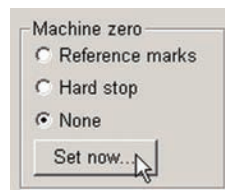

- 2 Click the Set now button to set machine zero.

## Displaying results in wide format

The contents of the Results window can be displayed in narrow or wide format.

Check the Display the coefficients... box to display the results window in wide format.

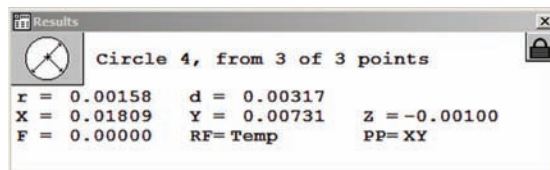
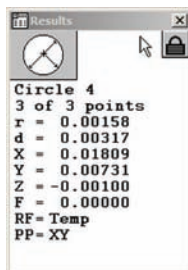

## Opening the last part automatically

The QC5200 can be configured to automatically open the last active part file upon startup. Check the Open last part... box to open the last part file.

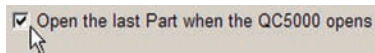

## Tracking user activity

User activities such as key presses and mouse clicks can be logged to facilitate troubleshooting and other diagnostic processes. The logged file is stored in the Recent Activity folder at the root of the QC5000 directory. Click the Enable tracking... box to log user activities.

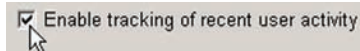

Click Help, Diagnostics, and then Show this session's activity to display the logged file.



### NOTE

Enabling this logging feature uses small amounts of system memory and processor time. However, older systems might run a little slower when the logging feature is enabled.

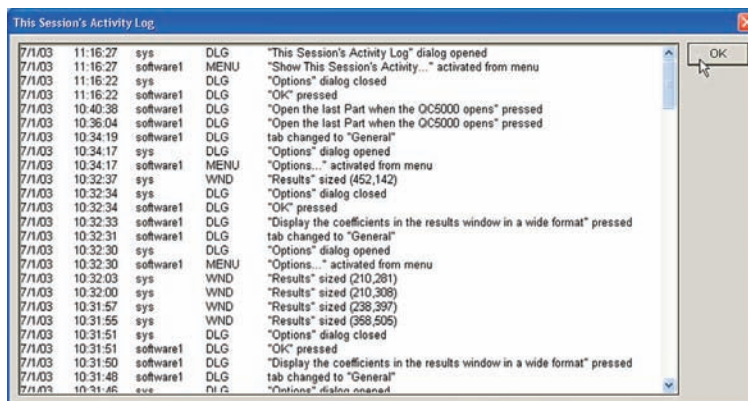
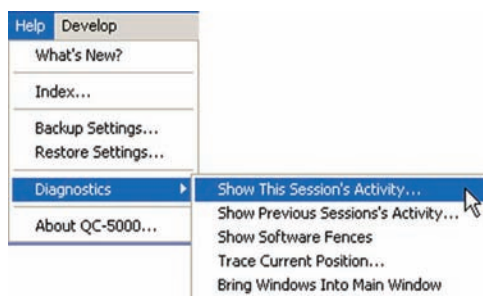

## Enable simple zeroing of the DRO axis positions

By default, when a DRO axis button is clicked, a zero position must be measured for the associated axis. Check the Enable simple zeroing... box to zero an axis immediately at its current position without measurement.

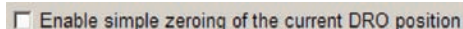

## Setting up the video probes

Many video measurement and display parameters are configured using tools provided in the VED screen.

Click the Tools/Options/VED menu item to display the VED screen.

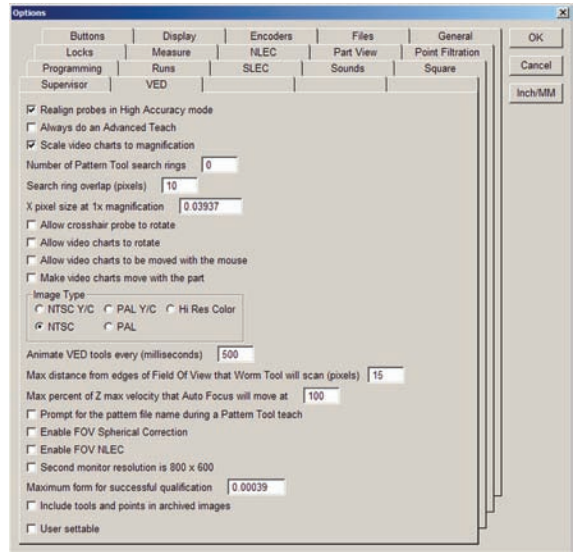

## Aligning the probe automatically and the high accuracy mode

VED probe alignment can affect the quality of feature data. Properly aligned probes optimizes feature measurement results.

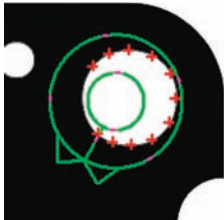

Poorly aligned probe

Check the Realign probes... box to automatically optimize the alignment of VED probes when they're fired.

Realign probes in High Accuracy mode

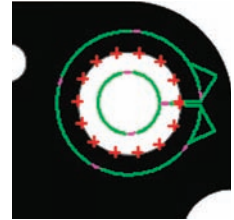

Realigned probe

## Specifying the advanced teach mode

Video probe edge recognition is optimized using either the Standard or Advanced edge teach tool.

The Standard edge teach tool automatically optimizes video edge recognition based on 1 of 4 specified edge algorithms; First, Strongest, Auto or Soft.

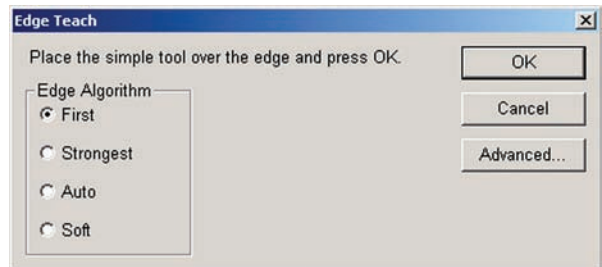

The advanced edge teach tool optimizes video edge recognition based on a specified edge algorithm or permits the user to optimize edge recognition manually.

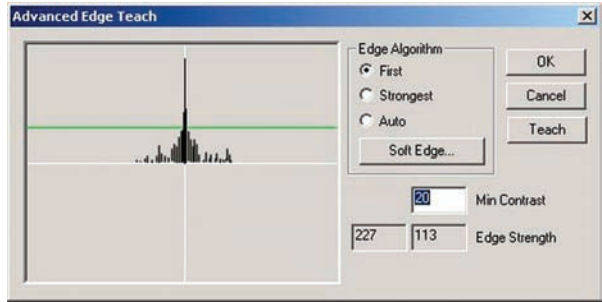

Check the Always do an advanced teach box to specify the advanced edge teach tool as the default.

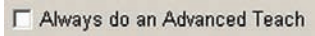

## Scaling video charts to magnification

Video charts are overlays that are superimposed over part images to facilitate visual inspections.

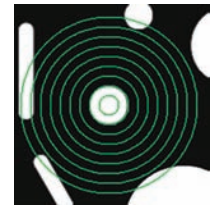

### NOTE

The video charts are drawings created for specific parts and saved as .dxf files in the QC5000 Imports directory.



Original magnification

Check the Scale video charts to magnification box to automatically maintain a consistent chart-to-image ratio as the video magnification is changed.

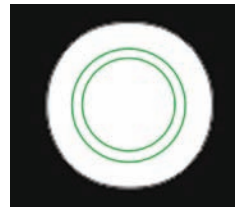

Chart not scaled



Chart scaled

## Specifying pattern search rings

Search rings expand the area evaluated by the pattern probe beyond the current field of view during CNC program execution. Each search ring expands the pattern tool search in a clockwise series of rectangles. The size of each rectangle depends on the pattern tool size and the search ring overlap specified.

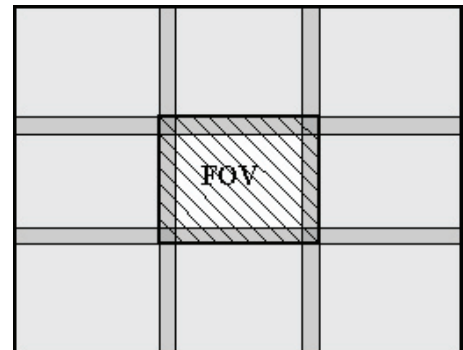

During program execution, the initial field of view is evaluated. If the target pattern is not found, and search rings were specified, the field of view is moved to the lower-left corner of the first search ring. Then the pattern search continues as a clockwise series of (field of view) rectangles is added until a feature is found.

If the target feature is not found, the search continues to the next ring, or stops if no additional rings were specified.

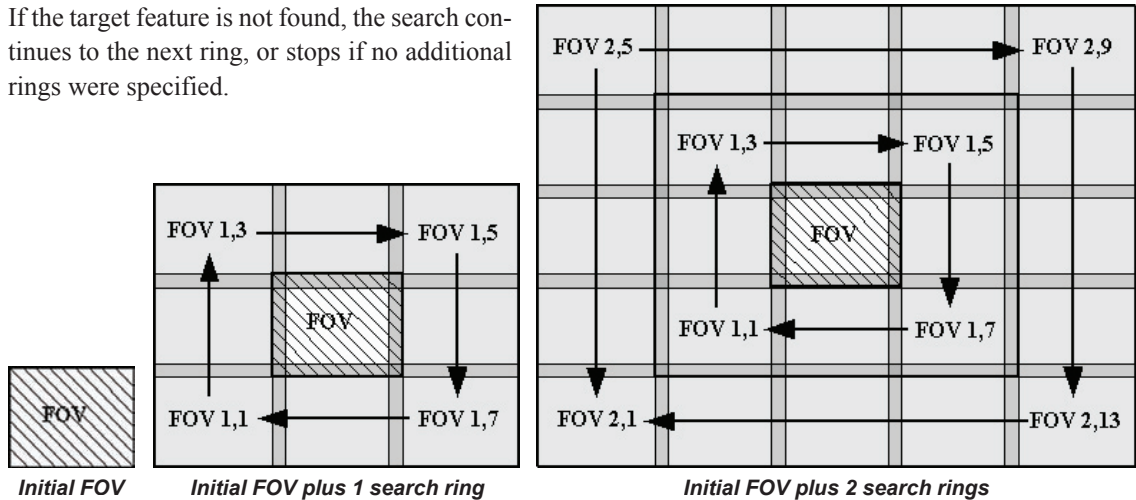

Enter the number of desired the search rings into the Number of pattern... field.

Number of Pattern Tool search rings

## Specifying search ring overlap

Pattern tool search rings and fields of view must overlap to ensure that target features will be found. This search ring overlap is specified in pixels.

Target features must be enclosed completely within a field of view to be recognized. Since features can sometimes be located across the boundary between two adjacent field of view rectangles, the specified search ring overlap must be slightly larger than the target feature, as shown in the example here.

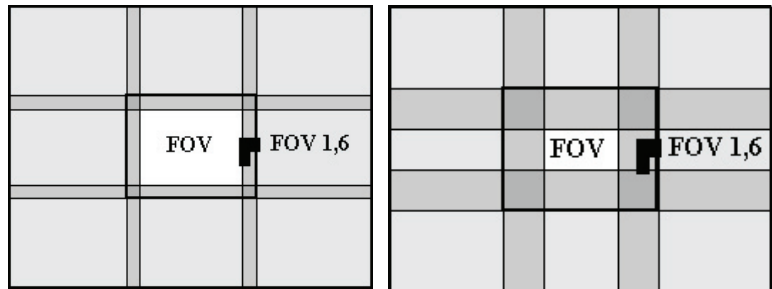

Enter the desired overlap in the Search ring overlap field in pixels.

Search ring overlap (pixels)

## Calibrating the display of magnification value

The video window image magnification is displayed in the bottom-right corner of the QC5000 main screen.

The image magnification depends on the optical characteristics of the system and must be found by performing the measurement procedure provided below.

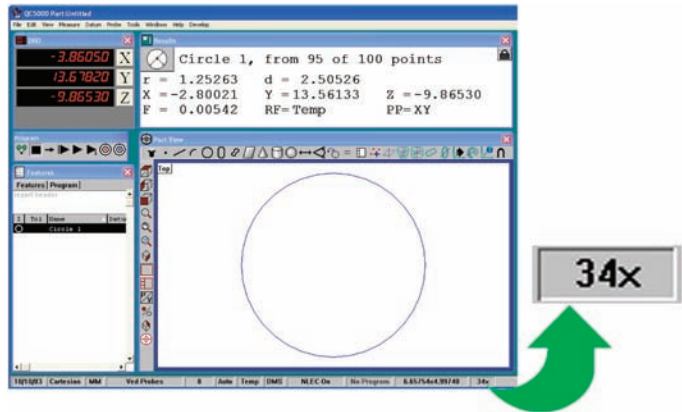

### Calibration procedure

#### Step 1

Verify that the X pixel size... field is set to 1.000



#### Step 2

Click Tools, Customize and then click the Status bar tab. True magnification must be enabled. If the True magnification box is not checked, click on True magnification and then click Show.

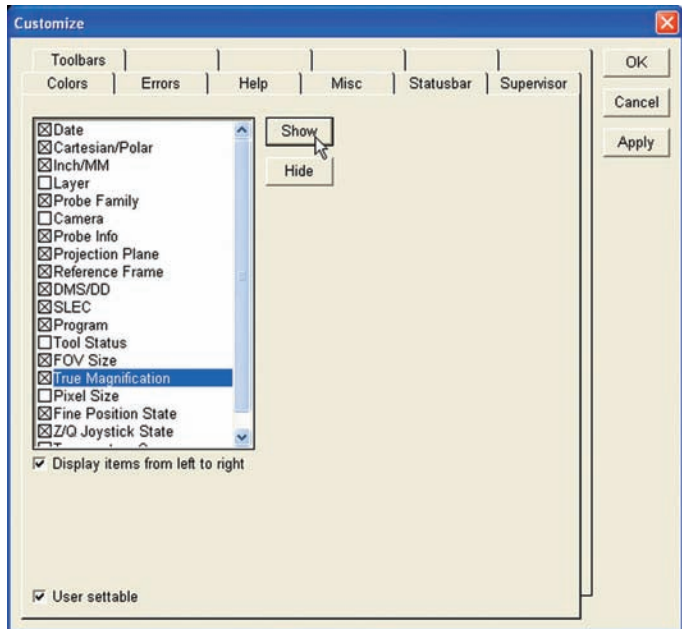

#### Step 3

Click OK to close the Customize screen, and then return to the Tools/Options/VED tab.

## Step 4

Bring a standard artifact into sharp focus in the video Window's field of view. The Metronics calibration slide is an excellent standard to use for this procedure.

## Step 5

Measure the distance between 2 of the standard's marks on the computer screen using a scale or ruler. Measure as great a distance as possible.

## Step 6

Calculate the measured magnification by dividing the measured distance (Step 5) by the actual distance shown on the standard.

$$\text{Measured magnification} = \text{Measured} / \text{Actual}$$

## Step 7

Calculate the pixel size factor by dividing the measured magnification by the magnification value currently displayed in the right corner of the status bar.

$$\text{Pixel size factor} = \text{Measured Magnification} / \text{Status bar value}$$

## Step 8

Enter the pixel size factor into the X pixel size... field.

X pixel size at 1x magnification

## Allowing crosshair probe rotation

Probes that detect edges are most effective when oriented orthogonally to the edge. Since feature edges can be positioned at any angle, edge detection probe rotation is enabled by default. However, crosshair probes are point measurement tools and probe rotation is disabled by default. Crosshair probe rotation can be useful when the feature geometry makes the crosshairs difficult to see on the screen.

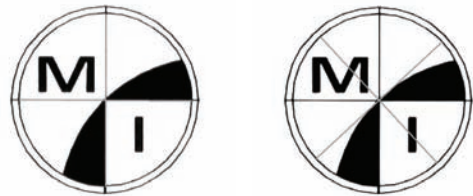

*Rotated crosshairs are easier to see against some backgrounds*

Check the Allow crosshair probe to rotate box to enable crosshair rotation.

Allow crosshair probe to rotate

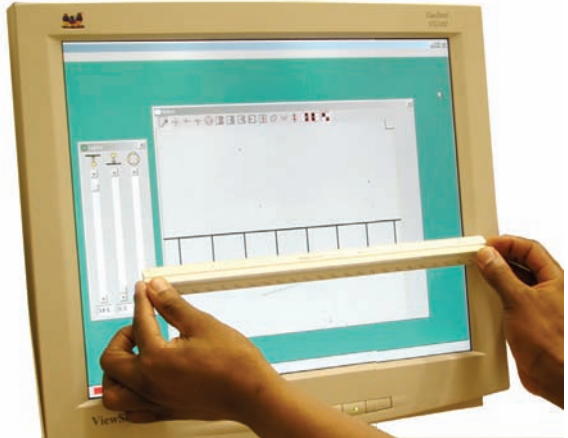

## Allowing video charts to rotate

Video chart rotation is disabled by default. Video chart rotation can be useful when the alignment of the part in the field of view does not match that of the imported chart.

Click on the Allow video charts to rotate box to enable video chart rotation.

Allow video charts to rotate

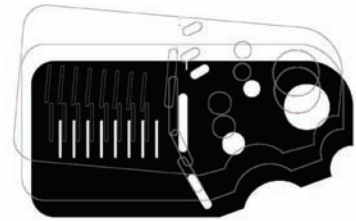

## Moving video charts with a mouse

The video window origin is located in the top-left corner of the video window. When a video chart is loaded, the video chart origin is positioned over the video window origin. This initial alignment can sometimes cause portions of the imported chart to fall outside the boundaries of the video window.

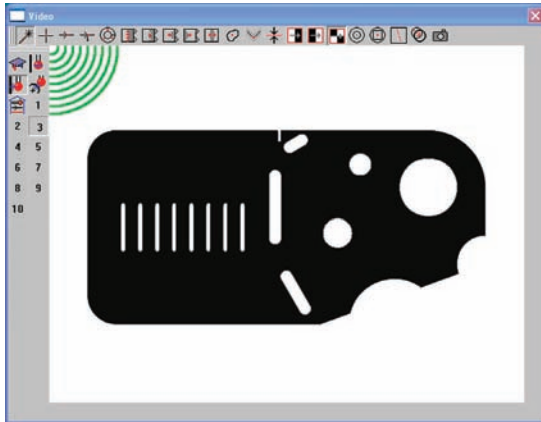

*A chart is clicked and dragged...*

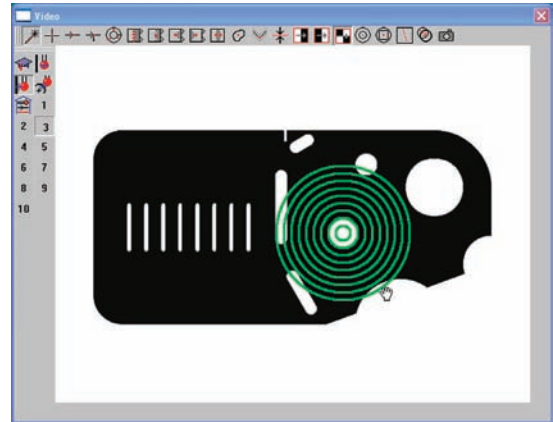

*from one location to another using the mouse*

Check the Allow video charts... box to allow repositioning of the chart using the mouse.

Allow video charts to be moved with the mouse

## Moving video charts with the part

Video charts are positioned over part features with the mouse. By default, if the part position is changed, the chart position must be realigned manually using the mouse. This is acceptable for small parts, but when parts and associated charts extend beyond the field of view, the part position will usually be changed repeatedly and manual realignments would reduce throughput.

Check the Make video charts... box to automatically maintain chart-to-part alignment as the part is moved.

Make video charts move with the part



## Specifying video camera image type

Check the Image type radio button that corresponds to the output format of your video camera system.

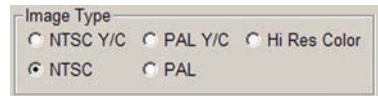

## Specifying video probe animation rate

Video probes are animated to indicate video scan direction and to enhance visibility. The animation shows dashed lines moving along the probe path in the direction of the scan.

Animation intervals are entered to increase or decrease the animation rate. Small intervals result in high rates and smooth animations, but commit more computer resources. Large intervals result in lower rates and animation hesitation, but commit fewer resources.

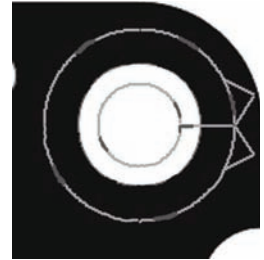

*Dashed lines move in the direction of the scan*

Enter the desired animation interval into the Animate VED... field in milliseconds.

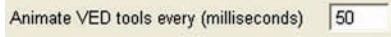

## Specifying maximum field of view for worm probe

The worm probe scans along an edge until the scanning process is complete, or the scanning is terminated by an error or by an enabled scan-limit boundary. The scan-limit boundary is shown in red when enabled, and in green when disabled.

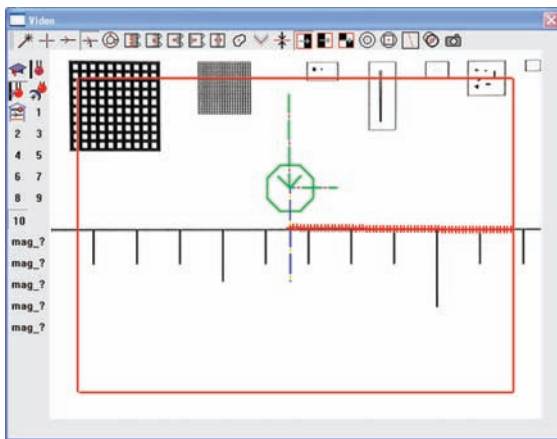

*Scan-limit boundary stops the scan*

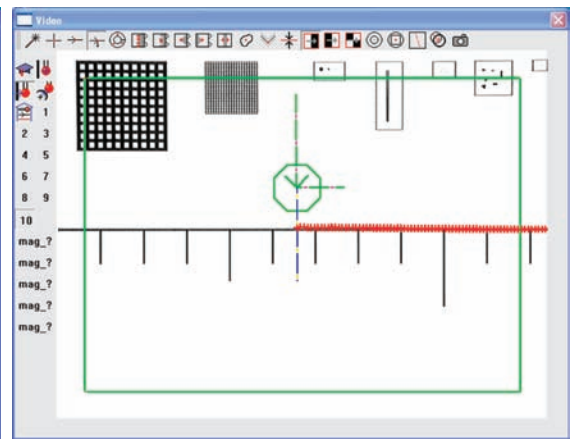

*Scan is allowed to continue beyond the field of view*

**NOTE**

A more detailed discussion of the worm tool is provided in [Chapter 4: Probes](#).

When the scan-limit is enabled, the limit boundary can be configured to prevent scanning within a specified number of pixels from the edge of the field of view. Limiting worm tool scanning to the center of the field of view eliminates the effects of lens-edge aberrations.

Enter the desired boundary distance into the Max distance from edge... field.

Max distance from edges of Field Of View that Worm Tool will scan (pixels)

## Specifying pattern file names

Whenever the pattern tool is taught a new pattern, it can be saved automatically in the Parts folder using a default filename, or can be saved in another folder using a user-specified filename.

The default file naming convention is:

Part name\_Pattern (n).5pt

Where n is incremented for each new file.

Check the Prompt for pattern file name... box to specify a pattern file name and storage location whenever a pattern is taught to the pattern tool.

Prompt for the pattern file name during a Pattern Tool teach

## FOV spherical and NLEC corrections

Normally, measurements are made at or near the center of the optical system to avoid aberrations normally present near lens edges. Spherical and NLEC corrections compensate for these aberrations, but can only be enabled by OEMs and distributors after performing specific calibration procedures.

Enable FOV Spherical Correction  
 Enable FOV NLEC

**NOTE**

Contact your OEM or distributor for more information regarding these two corrections.

**CAUTION**

Do not change the status of the Enable FOV spherical correction or Enable FOV NLEC check boxes without specific instructions from your OEM or distributor.

## Specifying a larger video window

Windows XP systems that include smaller monitors can sometimes benefit from larger live video part displays. The default display resolution of the monitor used for live video displays is 1024 X 768 pixels. Changing the resolution to 800 X 600 pixels enlarges the video display of parts.



### NOTE

**Larger video displays of parts do not provide increased measurement accuracy.**

To change the resolution of live video displays on Windows XP systems:

#### Step 1

Close the QC5000 program

#### Step 2

Right-click the desktop, click Properties and then click Settings.

#### Step 3

Click the monitor used for live video displays and then change the screen resolution to 800 X 600 pixels.

#### Step 4

Click OK to save the revised Settings. You will be asked if you wish to retain the new Settings. Click Yes.



#### Step 5

Launch the QC5000 program.

#### Step 6

Click Tools/Options/VED tab.

#### Step 7

Check the Second monitor resolution is 800 X 600 box.

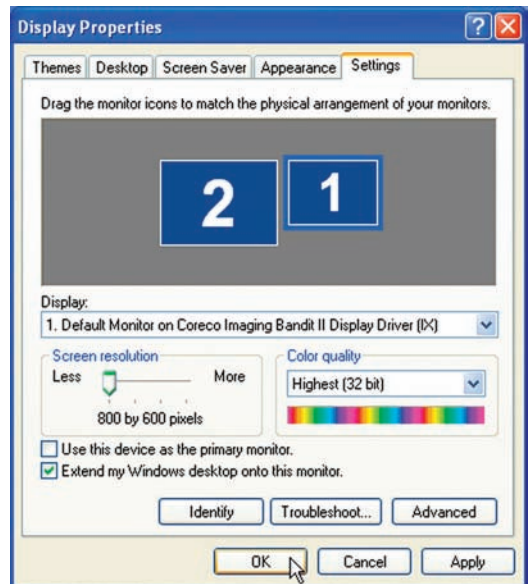

Second monitor resolution is 800 x 600

## Specifying the maximum form error for a valid pixel calibration

The pixel resolution must be calibrated for each magnification to ensure accurate measurement results. These calibrations are performed as part of the overall initial setup of the video probe system and are discussed in detail in [Chapter 4: Probes](#).

The pixel calibration relies on the measurement of a standard circle artifact. Accurate calibrations require high quality circle artifacts. The maximum form error allowed for circle artifact measurements can be specified to insure that the circle used for calibration meets a known minimum quality standard.

Enter the maximum allowable form error into the Maximum form for successful qualification field.

Maximum form for successful qualification 0.00039

## Including probes and points in live video image captures

Clicking the Tools/Capture Image menu item creates a bitmap (bmp) file of the live video window image and stores the file in the QC5000\Parts folder using a name that includes time and date information.

The captured image always includes the video camera field of view, and can also include the current video probe and any points that might have been acquired when the probe was fired.

Check the Include tools and points... box to include the probe and acquired point images.

Include tools and points in archived images

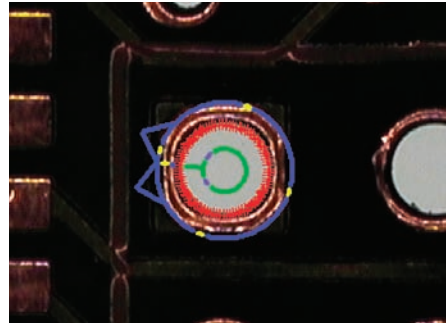

*The circle probe and acquired points are shown in the captured image*

## Setting up the joystick

Use the joystick screen in systems that include CNC functions to enable, calibrate, and configure motions controlled by the joystick on all axes.

Click the Tools/CNC/Joystick menu item to display the Joystick screen.

### Enabling and disabling joystick motion control

Check or clear the Enable box to enable or disable joystick motion control for the designated axes.

Enable  X  Y  Z  Q

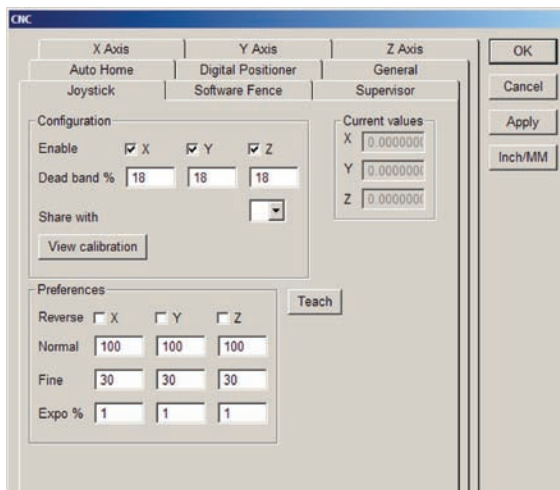

### Viewing current position values

The current joystick position is indicated by the Current Values fields. These values can range from a low of 0 to a high of 5.0. The center of each axis at rest should be near 2.5. The Current values displays provide useful information for joystick performance evaluations and troubleshooting.

### Sharing axes

When machine motion axes outnumber joystick axes, the Z and Q axes can be shared with the X and Y axes using buttons on the digital positioner as diagrammed in this example of sharing the Z axis.



#### NOTE

Refer to the description of the Tools/Options/Buttons screen for details regarding the configuration of digital positioner buttons.

To share the Z axis:

- 1 Enable the Z axis.

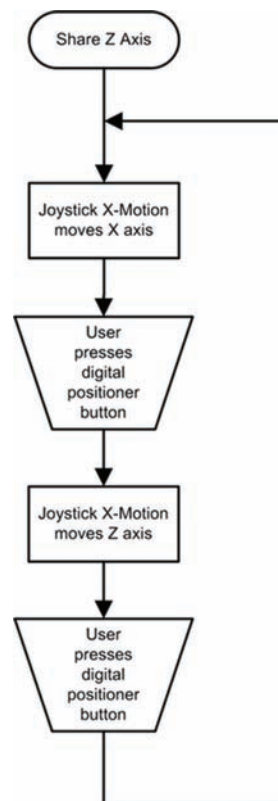
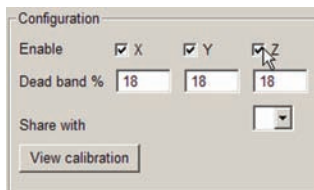

2 Select the axis with which to share the Z axis.

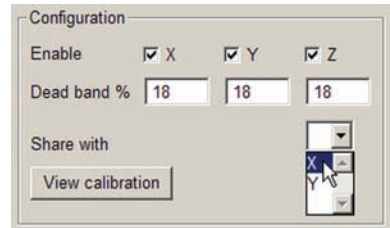

3 Assign Swap Z Joystick to a button of the digital positioner using the Tools/ Options/Buttons screen.

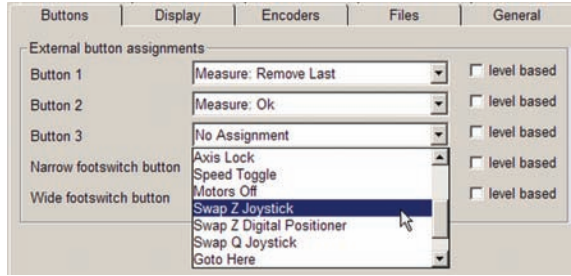

## Specifying a deadband

Mechanical vibrations in the work environment and joystick noise can generate small joystick output signals when the joystick is at rest. These signals can result in unintended axis motions. A deadband can be created around the joystick's rest (zero) position to prevent these axis motions.

Create the desired deadband around each axis zero position by entering the minimum percentage of the total joystick range of motion required to cause axis motion. The default deadband is 18% of the joystick's total range of motion.



## Calibrating the joystick

The full range of joystick motion must be calibrated for optimum control. To calibrate the joystick:

1 Click the Teach button. The Joystick Teach wizard will be displayed.

2 Follow the instructions provided by the wizard screens.

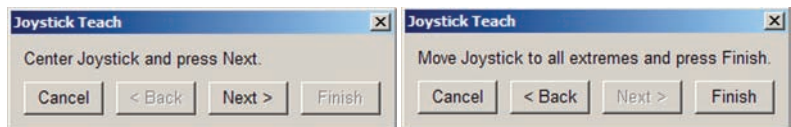

## Viewing calibration values

Joystick calibration values will fall somewhere between a low of 0 and a high of 5.0. Click the View Calibration button to display the current values.

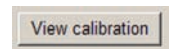

The Min and Max values should be almost evenly distributed around the center values. The center values should be approximately 2.5.

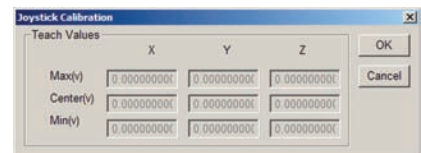

## Specifying normal and fine velocities

Normal velocity is generally used to move between probed points. Fine velocity is generally used to probe points. The normal and fine velocities of each axis are expressed as percentages of the maximum velocities specified in individual Tools/CNC/Axis set up screens.

| Preferences |                            |                                       |                                       |                            |
|-------------|----------------------------|---------------------------------------|---------------------------------------|----------------------------|
| Reverse     | <input type="checkbox"/> X | <input checked="" type="checkbox"/> Y | <input checked="" type="checkbox"/> Z | <input type="checkbox"/> Q |
| Normal      | 100                        | 100                                   | 100                                   | 100                        |
| Fine        | 30                         | 30                                    | 30                                    | 30                         |
| Expo %      | 1                          | 1                                     | 1                                     | 1                          |

Normal velocities are usually set as high as the manual joystick control of each axis will permit. The fine velocities are usually set to optimum probing velocities for probes (approximately 5 mm per second).

Enter the desired percentages directly into the Normal and Fine data fields of each axis. The default percentages are 100% for normal velocities, and 30% for fine velocities.

## Specifying the axis motion profile

The joystick control of axis motion can be linear, exponential or a mixture. Linear control causes the axis velocity to increase in direct proportion to joystick displacement. Exponential control causes little or no axis motion in response to early joystick displacements, but quickly increases the axis velocity toward the extreme end of joystick displacement.

Exponential control is useful when very small and precise motions are required at low velocities. The Expo % field is used to specify the amount of exponential control for each axis. This range can extend from 0% (linear control) to 100% (exponential control) as shown by the graph below.

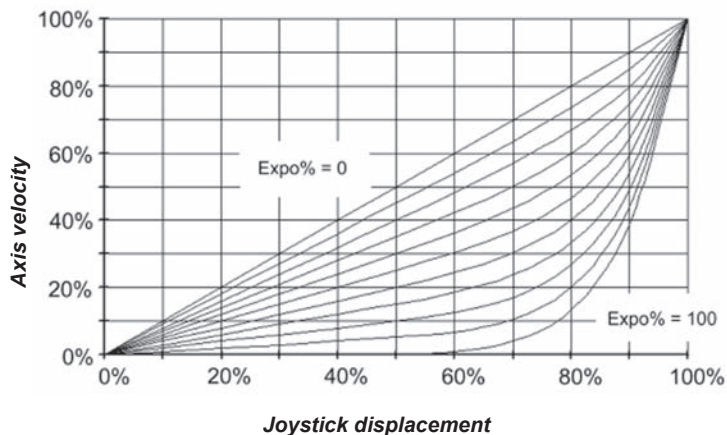

Enter the desired value into the Expo % field for each axis. The default values are 1% for each axis and provides nearly linear response.

|        |   |   |   |   |
|--------|---|---|---|---|
| Expo % | 1 | 1 | 1 | 1 |
|--------|---|---|---|---|

# Chapter 11:

## Problem Solving

The QC5200 is based on hardware and software common to the Metronics QC5000 series of products. Years of continuous improvement of this product family have resulted in extremely reliable operation and few, if any problems. Problems experienced with the operation of the QC5200 are likely to be the result of encoder issues, printer or cable incompatibilities, configuration or setup errors, file maintenance issues or encoder/transducer incompatibilities or malfunctions.

Some steps recommended for initial troubleshooting are shown in subsequent pages. These are typically the same initial steps that would be taken by a Metronics distributor or factory product support technician. Since most problems experienced in the field will have simple causes, and equally simple solutions, substantial time and expense can be saved by performing some straightforward troubleshooting of configuration settings and hardware connections prior to calling your Metronics distributor or the factory for assistance.

Here's what you'll find in this chapter:

|  |     |
|--|-----|
| QC5200 settings or appearance have changed. Everything looked<br>okay the last time you were on the system, now it's different ..... | 355 |
| A QC5200 Window is missing from the screen, but is enabled<br>in the QC5200 Windows menu .....                                       | 355 |
| Measurements are inaccurate or inconsistent.....   | 355 |
| An axis counts in the wrong direction .....  | 356 |
| Cannot drag data fields from the Results window into a template .....  | 357 |
| Changes to the QC5200 settings, window positions, etc. are not saved .....   | 357 |
| The QC5200 program doesn't launch, but other Windows programs do .....   | 358 |
| Cannot print from the QC5200 program.....  | 359 |
| A default template contains unwanted data or formatting .....  | 360 |
| Cannot make changes to the QC5200 settings.....  | 361 |
| The system seems slow .....  | 362 |
| Cannot see image in the live video window .....  | 363 |
| The auto focus does not work properly.....   | 364 |
| The measurements finish before I'm ready.....  | 365 |
| Cannot find captured images.....   | 365 |



## Troubleshooting

As you're troubleshooting, list the steps you use to identify and solve your problem. Should problems persist in spite of your efforts, gather the necessary product information listed at the end of this chapter, your list of troubleshooting steps, and contact your Metronics distributor or Metronics technical support for assistance.



### CAUTIONS

**Before making any changes to any QC5200 settings, go to the Help/Backup Settings. Then, create a backup file using a name that is easy to remember, such as the your name and the date (example: jsmith010905.qb2 for John Smith on Jan. 9, 2005).**

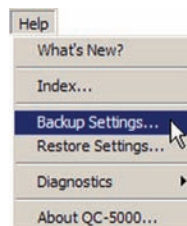

**Your QC5200 is an integral part of your measuring system. Changes to the QC5200 may significantly impact the accuracy and reliability of the system as a whole. The system should be fully calibrated at the time of installation. Changes made to the settings of the QC5200 may make the calibration ineffective or could worsen accuracy. If you have any questions or doubts about changes made as a result of your troubleshooting efforts, please contact your Metronics distributor or Metronics technical support for assistance.**

The remaining pages of this chapter contain a list of possible problems with probable causes and recommended solutions.

## Problem

*QC5200 settings or appearance have changed. Everything looked okay the last time you were on the system, now it's different.*

### Probable causes

- Another user may have made changes
- The system was not shut down correctly

### Recommended solution

- Use Help/Restore to restore previous settings

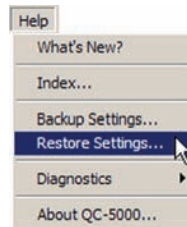

## Problem

*A QC5200 Window is missing from the screen, but is enabled in the QC5200 Windows menu.*

### Probable cause

- Someone clicked and dragged the window off-screen

### Recommended solution

- Use Help/Diagnostics/Bring Windows... to display all enabled QC5200 windows

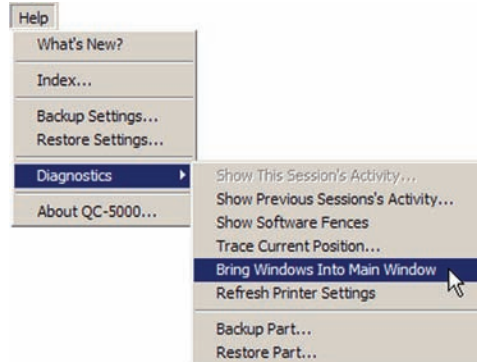

## Problem

*Measurements are inaccurate or inconsistent*

### Probable cause #1

- The axis encoders are not properly calibrated

### Recommended solution #1

- Calibrate the axis encoders using the material contained in [Chapter 9: Encoder Setup](#).

## Probable cause #2

- The video probes are not properly calibrated

## Recommended solution #2

- Calibrate the video probes using the material contained in [Chapter 4: Probes](#).

## Problem

### *An axis counts in the wrong direction*

## Probable cause

- The polarity (reversed) setting is incorrect

## Recommended solution

- Use the Tools/Options/Encoder tab to enter the correct encoder polarity by changing the Reverse setting.

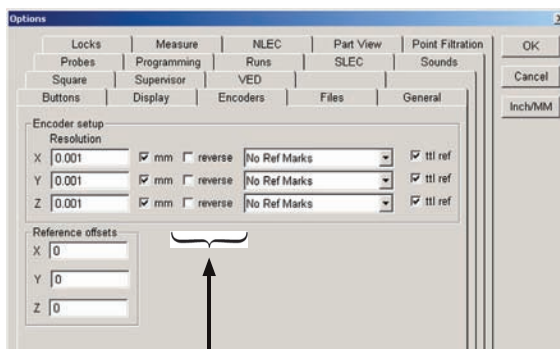

**Reverse  
encoder  
polarities**

## Problem

**Cannot drag data fields from the Results window into a template**

### Probable cause

- Templates have been locked to prevent modifications

### Recommended solution

- Use the Tools/Options/Locks tab to unlock the templates

Clear check mark to unlock templates

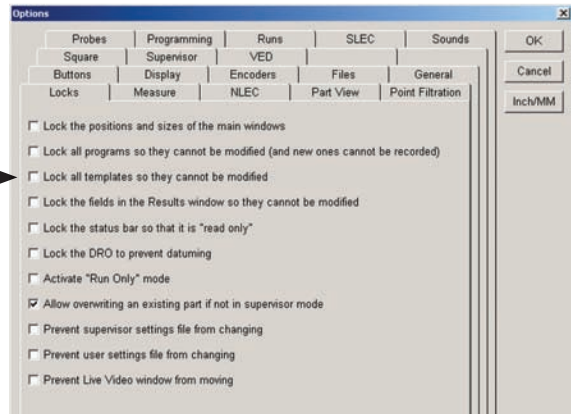

## Problem

**Changes to the QC5200 settings, window positions, etc. are not saved**

### Probable cause #1

- The *Save on exit* option is not enabled on the Tools/Options/General tab

### Recommended solution #1

- Use the Tools/Options/General tab to enable the *Save on exit* option

Check to enable *Save on exit*

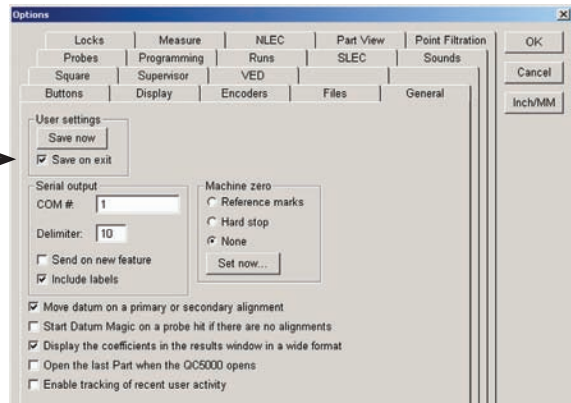

### Probable cause #2

- QC5200 functions are locked to prevent modifications

### Recommended solution #2

- Use the Tools/Options/Locks tab to unlock the desired functions

### Probable cause #3

- The user hasn't been assigned the required Windows operating system permissions to write to QC5200 folders

### Recommended solution #3

- The system administrator must revise the user permissions to support full read/write capabilities

## Problem

***The QC5200 program doesn't launch, but other Windows programs do***

### Probable cause

- QC5200 files were corrupted, possibly by an improper shut down or a power surge

### Recommended solution

- Attempt to repair the files using the following process



#### CAUTION

**Read the following instructions before attempting to perform them. If you are not completely comfortable performing the indicated steps, contact your Metronics distributor or the Metronics technical support group for assistance.**

- 1 Use Windows Explorer to find C:\QC5000 folder.
- 2 Check for backup files (.qb2) in the C:\QC5000\Backups folder. If no backup files exist, contact your Metronics distributor or send e-mail [techsupport@metronics.com](mailto:techsupport@metronics.com) to request assistance. If a valid backup file exists, proceed with this process.
- 3 Delete the following files from the root level of the QC5000 folder:
  - datamaps.5mp
  - supervis.5sy
  - untitled.5us.
- 4 Attempt to launch the QC5200 program. If the program doesn't launch properly, contact your Metronics distributor or send e-mail [techsupport@metronics.com](mailto:techsupport@metronics.com) to request assistance. If the program launches normally, proceed with this process.
- 5 Open the Tools/Options/Supervisor tab. Enter the supervisor password and check the *Keep privileges...* box.

6 Select the Help menu and click *Restore Settings*.

7 Select a backup file (.qb2) from the file dialog box.

8 Follow the prompts and close the QC5200 program.

9 Launch the QC5200 program. If problems persist,

contact your Metronics distributor or Metronics technical support at [techsupport@metronics.com](mailto:techsupport@metronics.com). Please supply Metronics serial number, which is a five digit number on a black label located on the rear of the PC.

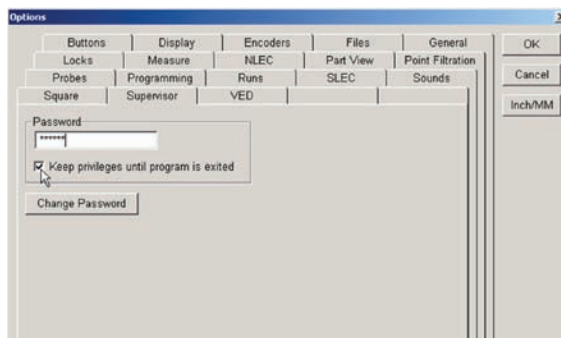
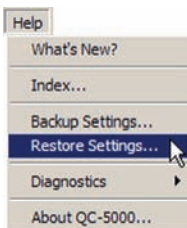

## Problem

### Cannot print from the QC5200 program

#### Probable cause #1

- The printer might not be properly powered

#### Recommended solution #1

- Check the printer's voltage selection switch, fuse, power switch, power cord and plug and outlet voltage.

#### Probable cause #2

- The printer cable might be incorrect, damaged or loose

#### Recommended solution #2

- Check the printers cable type, cable condition and the tightness of the cable connections

#### Probable cause #3

- The Windows operating system might not recognize the printer

#### Recommended solution #3

- Configure Windows to recognize the printer and perform a test print from the printer properties dialog box

## Probable cause #4

- The QC5200 program might not be configured to recognize the printer

## Recommended solution #4

- Click Help/Diagnostics/Refresh Printer Settings

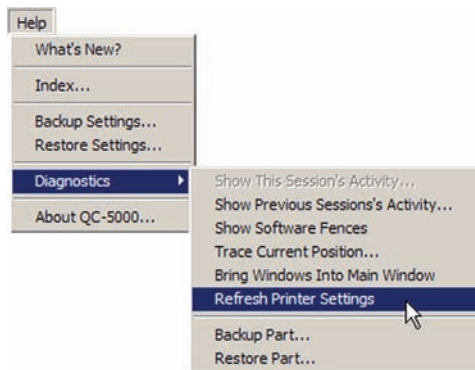

## Probable cause #5

- Spooling to Windows might not be possible with the current combination of QC5200 and the printer drivers

## Recommended solution #5

- Try printing directly to the printer. This printing option can be enabled in the printer's properties dialog box as follows:

- 1 Click the *Start button* and then click *Printers and Faxes*
- 2 Right-click the current printer
- 3 Click Properties and then click the Advanced tab
- 4 Click on *Print directly to printer*

## Problem

### ***A default template contains unwanted data or formatting***

## Probable cause

- The template has been modified or corrupted

## Recommended solution

The template needs to be returned to its original state. If one of the original default template files (.5ft) is deleted or renamed, the QC5200 will recreate the original file when the QC5200 program attempts to open it. Use Windows Explorer to delete the template file from the C:\QC5000\Templates folder while the QC5200 program is closed.

When the QC5200 launches click the Windows menu and open the template in question. The template will look as it did when the QC5200 was originally installed. The default templates are AllTol, CartLim, CartPIMi, Eurotol, Features, Program, Report, Runs, TolRep and TruePos. Only these default files will be recreated. Custom-made templates will not be recreated if deleted.

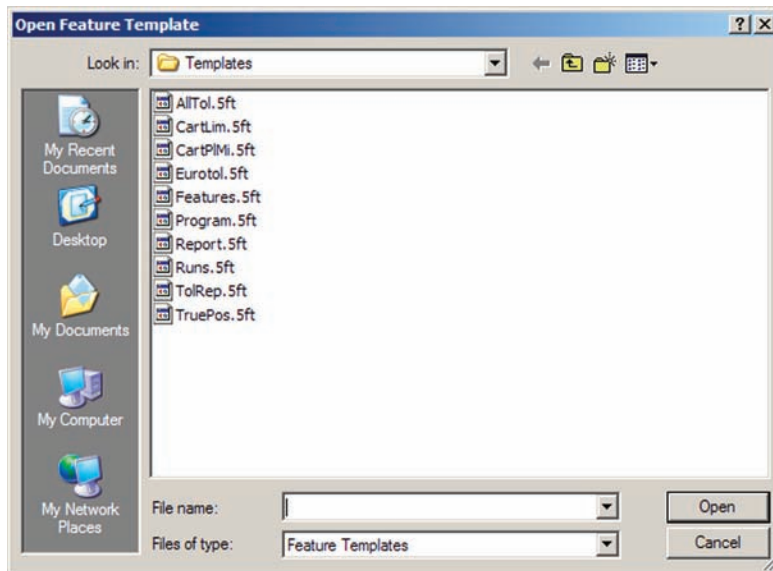
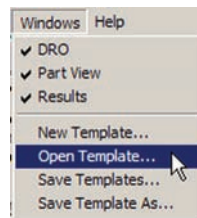

## Problem

**Cannot make changes to the QC5200 settings**

### Probable cause #1

- QC5200 functions are locked to prevent modifications

### Recommended solution #1

- Use the Tools/Options/Locks tab to unlock the desired functions

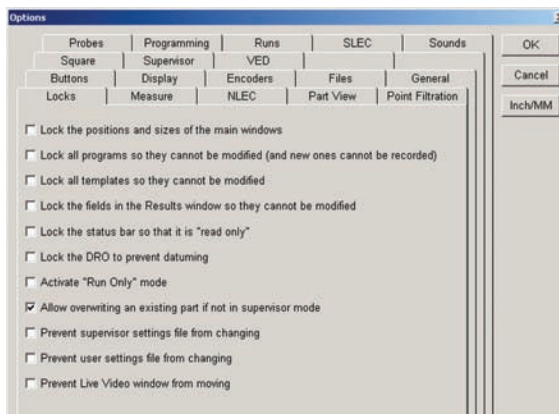



## Probable cause #2

- Network policies might limit the functions of local applications

## Recommended solution #2

- The network administrator must give more rights to the user

## Problem

*The system seems slow*

## Probable cause #1

- The video probe animation rate is too high

## Recommended solution #1

- Use the Tools/Options/VED to increase the value of the Animate VED Tools Every Millisecond field

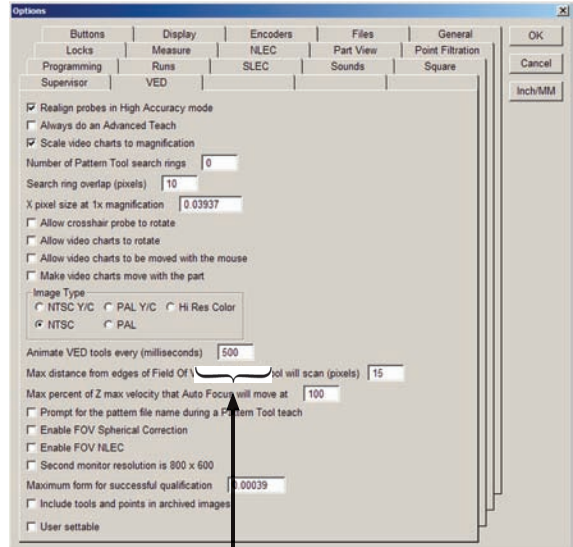

**VED probe  
animation  
rate**

## Probable cause #2

- Video probe continuous fire is enabled

## Recommended solution #2

- Right-click the live video window, click Other/Continuous Fire to toggle the continuous fire function off

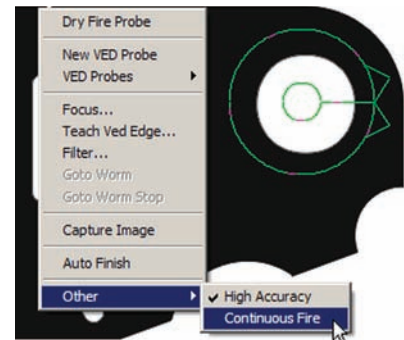

**Probable cause #3**

- Video image processing is enabled

**Recommended solution #3**

- Right-click the live video window, click Filter to access the image processing functions. Turn all unnecessary functions off.

**NOTE**

Image processing functions are generally not required for typical applications and should only be enabled by distributors and OEMs for special applications.

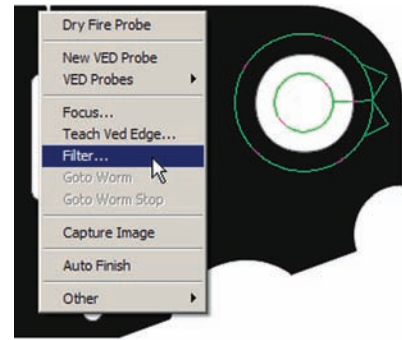
**Probable cause #4**

- Many templates are open during a measurement session

**Recommended solution #4**

- Close any templates that are not required for the session

***Problem******Cannot see image in the live video window*****Probable cause #1**

- The camera or camera cable is disconnected or faulty.

**Recommended solution #1**

- Confirm the proper connection and operation of the camera system.

**Probable cause #2**

- The part illumination system is disconnected or faulty.

**Recommended solution #2**

- Confirm the proper connection and operation of the part illumination system.

**Probable cause #3**

- The part illumination or video focus is not properly adjusted.

**Recommended solution #3**

- Adjust the part illumination system or video focus.

***Problem******The auto focus does not work properly*****Probable cause #1**

- Auto focus is intended as a final fine focus function, but is being asked to provide coarse focus adjustments.

**Recommended solution #1**

- Confine the use of the auto focus function to final fine focus tasks.

**Probable cause #2**

- The part lighting is inadequate for the auto focus function to be effective

**Recommended solution #2**

- Increase the part lighting

**Probable cause #3**

- The part contrast is inadequate for the auto focus function to be effective

**Recommended solution #3**

- Position the probe over a higher contrast area

**Probable cause #4**

- The video probes are not properly calibrated

**Recommended solution #4**

- Calibrate the video probes using the material contained in [Chapter 4: Probes](#).

## Problem

*The measurements finish before I'm ready*

### Probable cause #1

- The auto finish function is enabled

### Recommended solution #1

- Right-click the live video window, then click Auto Finish to toggle the auto finish function off

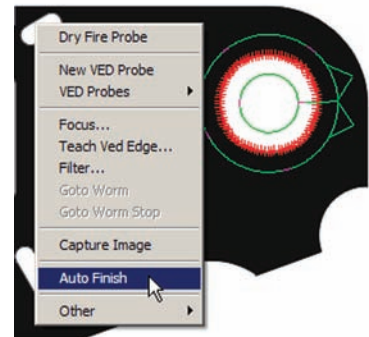

## Problem

*Cannot find captured images*

### Probable cause #1

- The images are stored in the C:\Parts directory unless intentionally removed

### Recommended solution #1

- Restrict access to the C:\Parts directory and retain original images when additional copies are required in other directories

## Getting help from your distributor

Performing the simple troubleshooting listed on the previous pages solves many problems experienced with the QC5200. If after performing this troubleshooting a problem persists, follow the steps listed below and contact your Metronics distributor for assistance.

- 1 Be prepared to discuss your troubleshooting steps.
- 2 Gather the following QC5200 product information:
  - Model number
  - Serial number
  - Approximate purchase date
  - Software version number from the Help/About screen

If you have an urgent issue and it becomes necessary to contact us directly, telephone our support staff at: (603) 622.0212

# Appendix A: File Import Formats

This appendix describes the various file import formats supported by the QC5200.

## **DXF**

The QC5200 supports a subset of this standard AutoCad, version 12 file format. It can handle points, lines, circles, arcs, poly lines, and splines.

## **IGS**

The QC5200 supports a subset of the “Initial Graphics Exchange Specifications” file format. It can handle points, lines, arcs, splines, and nurbs.

## **ASC**

This is a simple text file of point features. The default format is:

```
x1 y1 z1  
x2 y2 z2  
x3 y3 z3  
...
```

Each line of the file is a point feature, and specifies the x, y, and z position of the point. Each line of the file is defined in Import[Data]Format as a scanf format string. This data item is located in the Import.Met file and could be changed if necessary to take into account commas or other characters.

## **SAC**

This is a simple text file of circle features. It can have one of 2 formats.

The first format is:

```
CI x1, y1, z1  
CI x2, y2, z2  
CI x3, y3, z3  
...
```

The second format is:

```
C1 x1, y1, z1  
C2 x2, y2, z2  
C3 x3, y3, z3  
...
```

Each line of the file is a circle feature, and specifies the x, y, and z position of the circle. The CI or Cn is ignored by the QC5200.

## QC5200 Series User's Guide

### TAP

This is a text file of circle features (“Holes”). It can be created by CAD programs to describe positions of holes on a circuit board. The format is:

```
%  
T2C0.0140F200S100  
X-001400Y027650  
X-001060Y006740  
...  
T1C0.0100F200S100  
X-001100Y012825  
...
```

The % is ignored by the QC5200.

The lines in the file beginning with X define the xy position of the Hole. The values are in microns (e.g. -001400 is 1.4 mm).

The lines in the file beginning with T define the diameter for each of the Holes that following the T line, up until the next T is encountered. The diameter size begins after the C and ends at the F.

### DRL

This import option can consist of 1 or 2 text files. They both have the same file name, but one has a DRL extension and the other has a TOL extension. After the file prompt, the user is asked:

- Digits Before Decimal point (for diameters and positions in both files)
- Units (of the positions in DRL file)
- Scale Factor (for diameters and positions in both files)

As an example of how numbers are interpreted, if Digits Before Decimal point is 3, Units is metric, Scale Factor is 1000, and the numeric string “12345”:

The number used by the QC5200 would be  $123.45 / 1000 = 0.12345$  mm.

The DRL file is always required, and its format is:

```
%  
T01  
X18165Y1342  
X18375Y14  
...
```

The % is ignored by the QC5200.

The lines of the file beginning with X define the xy position of the Hole.

## ***File Formats***

The lines of the file beginning with T define the diameter of holes for each of the holes that following the T line, until the next T is encountered. The number immediately after the T refers to a hole size identifier in the TOL file. If there is no TOL file, or if the identifier cannot be found, the user is prompted to enter in the hole diameter.

The TOL file defines hole sizes and uniquely identifies them. The format is:

```
-----  
-----  
-----  
T1 00030  
T2 01234  
T3 00123  
...
```

The 3 dashed lines are ignored.

The number immediately after the T is an identifier (label) for a hole size. The number immediately after the T identifier is the hole size, in metric units.



# Appendix B: ASCII Codes

| ASCII (Decimal) | Value | Description                      | ASCII (Decimal) | Value | Description   | ASCII (Decimal) | Value | Description      |
|-----------------|-------|----------------------------------|-----------------|-------|---------------|-----------------|-------|------------------|
| 0               | NUL   | Null character                   | 44              | ,     | Comma         | 88              | X     |                  |
| 1               | SOH   | Start of Header                  | 45              | -     | Minus or dash | 89              | Y     |                  |
| 2               | STX   | Start of Text                    | 46              | .     | Dot           | 90              | Z     |                  |
| 3               | ETX   | End of Text                      | 47              | /     | Forward slash | 91              | [     | Left bracket     |
| 4               | EOT   | End of Transmission              | 48              | 0     |               | 92              | \     | Back slash       |
| 5               | ENO   | Enquiry                          | 49              | 1     |               | 93              | ]     | Right racket     |
| 6               | ACK   | Acknowledgment                   | 50              | 2     |               | 94              | ^     | Caret/circumflex |
| 7               | BEL   | Bell                             | 51              | 3     |               | 95              | _     | Underscore       |
| 8               | BS    | Backspace                        | 52              | 4     |               | 96              | `     | Grave            |
| 9               | HT    | Horizontal Tab                   | 53              | 5     |               | 97              | a     |                  |
| 10              | LF    | Line Feed                        | 54              | 6     |               | 98              | b     |                  |
| 11              | VT    | Vertical Tab                     | 55              | 7     |               | 99              | c     |                  |
| 12              | FF    | Form Feed                        | 56              | 8     |               | 100             | d     |                  |
| 13              | CR    | Carriage Return                  | 57              | 9     |               | 101             | e     |                  |
| 14              | SO    | Shift Out                        | 58              | :     | Colon         | 102             | f     |                  |
| 15              | SI    | Shift In                         | 59              | ;     | Semi-colon    | 103             | g     |                  |
| 16              | DLE   | Data Link Escape                 | 60              | <     | Less than     | 104             | h     |                  |
| 17              | DC1   | XON - Device Control 1           | 61              | =     | Equal sign    | 105             | i     |                  |
| 18              | DC2   | Device Control 2                 | 62              | >     | Greater than  | 106             | j     |                  |
| 19              | DC3   | XOFF - Device Control 3          | 63              | ?     | Question mark | 107             | k     |                  |
| 20              | DC4   | Device Control 4                 | 64              | @     | AT symbol     | 108             | l     |                  |
| 21              | NAK   | Negative Acknowledgement         | 65              | A     |               | 109             | m     |                  |
| 22              | SYN   | Synchronous Idle                 | 66              | B     |               | 110             | n     |                  |
| 23              | ETB   | End of Transmission Block        | 67              | C     |               | 111             | o     |                  |
| 24              | CAN   | Cancel                           | 68              | D     |               | 112             | p     |                  |
| 25              | EM    | End of Medium                    | 69              | E     |               | 113             | q     |                  |
| 26              | SUB   | Substitute                       | 70              | F     |               | 114             | r     |                  |
| 27              | ESC   | Escape                           | 71              | G     |               | 115             | s     |                  |
| 28              | FS    | File Separator                   | 72              | H     |               | 116             | t     |                  |
| 29              | GS    | Group Separator                  | 73              | I     |               | 117             | u     |                  |
| 30              | RS    | Request to send/record Separator | 74              | J     |               | 118             | v     |                  |
| 31              | US    | Unit Separator                   | 75              | K     |               | 119             | w     |                  |
| 32              | SP    | Space                            | 76              | L     |               | 120             | x     |                  |
| 33              | !     | Exclamation mark                 | 77              | M     |               | 121             | y     |                  |
| 34              | "     | Double quote                     | 78              | N     |               | 122             | z     |                  |
| 35              | #     | Number sign                      | 79              | O     |               | 123             | {     | Left brace       |
| 36              | \$    | Dollar sign                      | 80              | P     |               | 124             |       | Vertical bar     |
| 37              | %     | Percent                          | 81              | Q     |               | 125             | }     | Right brace      |
| 38              | &     | Amperсанд                        | 82              | R     |               | 126             | ~     | Tilde            |
| 39              | '     | Single quote                     | 83              | S     |               | 127             | DEL   | Delete           |
| 40              | ()    | Left/ropering parenthesis        | 84              | T     |               |                 |       |                  |
| 41              | *     | Right/closing parenthesis        | 85              | U     |               |                 |       |                  |
| 42              | *     | Asterisk                         | 86              | V     |               |                 |       |                  |
| 43              | +     | Plus                             | 87              | W     |               |                 |       |                  |

# Appendix C: Tolerances

## Concentricity tolerance

The mathematical definition of concentricity is explained in detail in the ASME Y14.5M-1994 standard and involves “the midpoints of opposing elements” in the determination of actual concentricity. This is not practical in a discrete point measuring system, so the QC5000 software uses the center of the feature (determined by the best fit) to estimate the concentricity.

## Reference Features

When a reference feature is called for in a tolerance definition, the reference feature will nearly always refer to a datum feature such as a skew line or datum circle. The field is required except for the MMC / LMC tolerance case described next.

## Reference feature called for in MMC or LMC circle tolerance

If the reference feature is a datum circle, and if that datum circle has an MMC or LMC tolerance applied, then a bonus tolerance may be derived from the reference feature and applied to the feature as a bonus if so specified in the drawing. This is an optional field.

## Projected zone

The user may optionally call out an projected tolerance zone when defining a tolerance on the true position of an axis. This allows the user to determine, for example if the limited measured portion of a parallel line remains parallel at some point outside the measurable portion. The fields are optional. The projected zone is specified by dimensions in the appropriate axis. projecting the parallelism zone of a horizontal line would require specifying the X position of the start and end of the zone.

# Index

## Symbols

.5ft 335  
.5io 335  
.5pa 335  
.5ws 335  
.asc 333  
.drl 334  
.dxf 333  
.dxf files 252  
.igs 333  
.sac 333  
.tap 334  
2-D part features 1

## A

Aberrant data points 270  
Access to settings 337  
Access to setup screens 318  
Adding and deleting data 225  
Adding and deleting template content 19  
Adding a comment to a program 255  
Adding buttons to a toolbar 309  
Adding graphics 236  
Adding magnifications 116, 118, 119  
Adding multiple data fields 226  
Adding special steps to a program 255, 272  
Adding text 233  
Adjusting light control 77  
Advanced teach (edge) 126, 340  
Advanced programming mode 316  
Advanced search criteria 26  
Algorithm 46  
Aligning column titles and data 231  
Aligning the probe 340  
Alignment 140  
Allowing or prohibiting toolbar docking 311  
Alltol 21  
Analog encoders 290, 293  
Angle constructed from an angle 195

Angle constructed from two lines 195  
Angle constructions 195  
Angle tolerances 214  
Angularity tolerances 213  
Angular display units 58  
Animation rate 346, 362  
Appearance has changed 355  
Appending data fields 228  
Arcs 99, 148  
Arc constructed from an arc 194  
Arc constructed from an arc and a distance 194  
Arc constructed from multiple features 194  
Arc constructions 194  
Arrow heads 239  
ASCII code 338  
ASME Y14.5M-1994 standard 201  
Assistance 353  
Associating lighting with magnifications 77  
Associating zoom positions with magnifications 119  
Audio prompting 273  
Automatically complete point measurements 321  
Automatic backups 336  
Automatic magnification 169  
Automatic redraw of part view 323  
Automatic text entry 235  
Auto finish function 52, 365  
Auto focus 122, 364  
Auto focus does not work properly 364  
Auto programming 249, 252  
Auto programming measurement steps 253  
Average 85, 135  
Average probe 91  
Axis counts in the wrong direction 356  
Axis identifiers 12  
Axis limit switches 292  
Axis motion profile 352  
Axis PC card 1  
Axis resolutions 292  
Axis travel 292  
Axis velocity 290

**B**

Backups 332, 336  
Backup file 332  
Best-fit algorithm 149  
Beyond the field of view (measuring) 104  
Bidirectional tolerances 207  
Bilateral tolerance 212  
Blob 85, 135, 155  
Blob probe 101, 155  
Bonus 209  
Bores 209  
Bosses 209  
Breakpoints to pause program execution 287  
Buffer 85, 135  
Buffer probe 89, 106  
Buttons (toolbar) 55  
Button functions 327  
Button functions that are invoked only once 327  
Button functions that can be momentary  
or toggled 328  
Button inserts a goto here step 329  
Button pauses the current program execution 329  
Button runs the current program 329  
Button toggles all axis motors on or off 328, 329  
Button toggles all axis motor speeds between fast  
and slow 328  
Button toggles the axis lock function on or off 328  
Button toggles the vertical joystick motion between  
the Y-axis and the rotary Q-axis 329  
Button toggles the vertical joystick motion between  
the Y-axis and the Z-axis 329  
Button toggles the vertical trackball motion between  
the Y-axis and the Z-axis 329

**C**

CAD files 3  
Calibrating analog encoders 293  
Calibrating auto focus 122  
Calibrating offset 129  
Calibrating pixel resolution 127  
Calibrating the display of magnification value 343  
Calibrating the joystick 351  
Calibrating video edge recognition (teach) 124  
Calibration values 351

Camera 363  
Camera cable 363  
Camera image type 346  
Camera magnification 15  
Camera skew 132  
Cancel 52  
Cannot drag data fields 357  
Cannot find captured images 365  
Cannot make changes to the QC5200  
settings 361, 363, 364, 365  
Cannot print from the QC5200 program 359  
Cannot see image in the live video window 363  
Capture 135  
Captured images 365  
Captures 349  
Capture image 37, 52  
Cartesian coordinate 11  
Cartesian or polar coordinates 29, 33  
Changes are not saved 357  
Change feature 27, 42  
Change name 47  
Change toolbar title 54  
Changing item colors 301  
Changing parents of construction features 283  
Changing probe size 80  
Changing the order of columns 231  
Changing the target position for probing 282  
Changing toolbar shape 56  
Charts 84  
Chart rotation 345  
Circles 85, 98, 135  
Circles constructed from two circles 193  
Circle constructed from a circle 191  
Circle constructed from a circle and  
a distance 192  
Circle constructed from more than  
three features 191  
Circle constructed from three features 191  
Circle probe 98, 106  
Circularity tolerances 211  
Circular shapes 240  
Clearing step selections 281  
Close the part when done running 260  
CNC control 3  
CNC control functions 37

- CNC functions 36
  - CNC mode 275
  - CNC mode steps 45
  - CNC motor operation 37
  - CNC movement warnings 315
  - CNC servo motor 1
  - CNC stepper motor 1
  - Colors 301
  - Color list items 301
  - Color of text 234
  - Columns 230
  - Comma separated variable (.csv) file 63
  - Comment 255, 272
  - Compensating for camera skew 132
  - Complete a measurement 284
  - COM port 337
  - Concentricity tolerances 211
  - Configuring joystick and footswitch buttons 327
  - Configuring measurement parameters 320
  - Configuring the highest magnification 121
  - Configuring the lower magnifications 121
  - Constructed features 325
  - Constructing a datum zero point 142
  - Constructing features 172, 283
  - Continuous probe firing 52, 83, 362
  - Contrast values 126
  - Controlling program execution 287
  - Coordinate system 11, 17, 58
  - Coordinate zero 12
  - Copy 42, 45
  - Copying, pasting and deleting program steps 285
  - Corrections 347
  - Counter setup 292
  - Counter window 292
  - Counts in the wrong direction 356
  - Count direction 296
  - Create preliminary skew and datum 110
  - Create video probes 105
  - Creating an arc 199
  - Creating a circle 198
  - Creating a datum automatically 110
  - Creating a distance 198
  - Creating a line 197
  - Creating a new template 39
  - Creating a point 197
  - Creating custom toolbars 313
  - Creating custom workspaces 59
  - Creating features 196
  - Creating programs 250
  - Creating the buffer probe 106
  - Creating the circle probe 106
  - Creating a new part 251
  - Creating the simple probe 105
  - Creating the worm probe 107
  - Creating toolbars 57
  - Crosshair 85, 135, 266
  - Crosshair probe rotation 344
  - Current position values 350
  - Cursor 32
  - Curvature 290
  - Customizing output 3
  - Customize menu 53
  - Customizing and creating toolbars 57
  - Customizing colors 301
  - Customizing toolbars 309
  - Custom toolbars 313
  - Custom workspaces 59
  - Cut 42, 45
  - Cutting, copying, pasting and deleting program steps 285
  - Cutting steps 285
- ## D
- Database 219
  - Database content 18
  - Data collection parameters 135
  - Data points 270
  - Data shifts during profile fit analyses 161
  - Date 58, 330
  - Datum 22, 63, 67, 110, 251
  - Datum menu 35
  - Datum zero point 141
  - DDE output 24, 45, 48, 243
  - Deadband 290, 351
  - Default template contains unwanted data or formatting 360
  - Delete current part 24
  - Delete selection 42, 45, 48, 50
  - Deleting columns 230

- Deleting data 225, 229
  - Deleting magnifications 120
  - Deleting program steps 285
  - Deleting rows 229
  - Deleting steps 285
  - Deleting template content 19
  - Deleting text 236
  - Demonstration (quick start) 63
  - Description of file types 332
  - Dimensional data 20
  - Direction 80
  - Disabling full CNC mode 275, 276
  - Disabling joystick motion control 350
  - Disabling light associations 78
  - Disabling program steps 288
  - Disabling raised edges for toolbar buttons 310
  - Disabling run time graphic displays 275
  - Display/guide 27
  - Display/hidden 27
  - Display/phantom 27
  - Display/show name 27
  - Display/show note 27
  - Displaying active program steps during
    - program execution 316
  - Displaying and hiding windows 39
  - Displaying a feature in all templates 326
  - Displaying current toolbar buttons 309
  - Displaying distances as absolute values 321
  - Displaying features with numbers 324
  - Displaying features with numbers and names 325
  - Displaying feature numbers and names on
    - part views 323
  - Displaying guide features 269
  - Displaying only features 324
  - Displaying or hiding toolbars 53
  - Displaying parts and probe position 322
  - Displaying phantom features 269
  - Displaying results in wide format 338
  - Displaying the distance to target surfaces for
    - CNC moves 330
  - Display menu 53
  - Display mode 257
  - Display of feature types 320
  - Display of form error whiskers 169
  - Display of images 274
  - Display of magnification 343
  - Display of resolution, time and date 330
  - Distances as absolute values 321
  - Distances constructed from an arc and
    - a circle 189
  - Distances constructed from a line and an arc 188
  - Distances constructed from a line and
    - a circle 187
  - Distances constructed from a point and a arc 186
  - Distances constructed from a point and
    - a circle 186
  - Distances constructed from a point and a line 185
  - Distances constructed from a slot and an arc 190
  - Distances constructed from a slot and
    - a circle 189
  - Distances constructed from two arcs 190
  - Distances constructed from two circles 189
  - Distances constructed from two lines 187
  - Distances constructed from two points 185
  - Distance constructed from a distance 185
  - Distance constructed from a line 187
  - Distance constructed from a line and a slot 188
  - Distance constructed from a point and a slot 186
  - Distance constructed from two distances 188
  - Distance constructed from two slots 190
  - Distance to target surfaces for CNC moves 330
  - Distributor (contacting for assistance) 366
  - Docked toolbars 12
  - Docking 311
  - Docking and undocking toolbars 56
  - Do not report any errors during program
    - execution 260
  - Dragging and dropping data 71
  - Drawing graphics 238
  - DRO 39
  - DRO colors 302
  - DRO window 11
  - Dry firing probes 51, 83
- ## E
- Edge detection 75, 81
  - Edge detection order 81
  - Edge detectors 266
  - Edge position in the DRO 330

Edge recognition (teach) 124  
Edge recognition performance 125  
Edge strength 126  
Edge teach 126  
Editing 9, 22  
Editing feature point filtration 270  
Editing functions 42  
Editing headers and footers 233  
Editing individual steps 282  
Editing initial program settings 265  
Editing functions (templates) 45  
Editing templates 225  
Editing text 233  
Edit menu 25  
Elliptical and circular shapes 240  
Empty feature list before running 260  
Empty locations within the palette 264  
Enabling and disabling joystick motion control 350  
Enabling and disabling light associations 78  
Enabling or disabling full CNC mode 275  
Enabling or disabling raised edges for toolbar buttons 310  
Enabling or disabling run time graphic displays 275  
Enabling sounds during program execution 315  
Enabling the advanced programming mode 316  
Encoders 293  
Encoder count direction 296, 331  
Encoder parameters 331  
Encoder reference marks 296, 331  
Encoder resolution 292, 296, 331  
Encoder setup 289, 296  
Encoder setup program 289  
Encoder unit of measure 296, 331  
English or metric units 29, 33  
Equal bilateral tolerances 162  
Errors during program execution 260  
Error correction 58  
Error limit 271  
Error messages 306  
Error whiskers 169  
Establishing the measurement reference 139  
Eurotol 21  
Excel (Microsoft) 3

Execution 260, 275, 287  
Exit 24  
Expand a super step 282  
Exponential control 352  
Export 24  
Exported data 3  
Exports 333  
Export file 333  
Export results 63  
Extracted data points 270

## F

Failed 167  
Failure to select features 316  
Fail icons 205  
Farthest probe 85, 94, 135  
Features 2, 12, 18, 69  
Features for a construction 321  
Features template 20  
Features with numbers 324  
Features with numbers and names 325  
Feature alternatives 47  
Feature data 17, 20  
Feature display defaults 320  
Feature display mode 257  
Feature icons 217, 218  
Feature list 260  
Feature measurements supported 145  
Feature measurement results 11  
Feature name 257, 270  
Feature numbers and names on part views 323  
Feature point filtration 270  
Feature properties 27, 42, 43, 48, 50, 257, 269  
Feature selection zones size 322  
Feature stamp colors 302  
Feature stamp window 270  
Feature template 217  
Feature tolerances 70  
Feature types 47, 320  
Fields 49  
Field of view 104  
Field of view for worm probe 346  
File 22  
File formats 23

- File menu 23
- File names 347
- File names, locations and backups 332, 336
- File operations 9
- File types 332
- Filter 51
- Filtered data points 27, 165, 170
- Filtering the worst (form error) data 170
- Filter functions 36
- Filtration 257, 270
- Filtration error limit 271
- Filtration process 270
- Filtration standard deviation range 271
- Finalizing feature properties 257
- Finalizing program properties 258
- Finding features when part variations exist 113
- Finding the pattern 109
- Find and teach precisely located features 111
- Find features 26
- Find feature dialog box 26
- Fine position 58
- Fine speed 290
- Fine velocity 352
- Fire probe 51
- Firing video probes 83
- First edge 125
- Fit algorithm 46
- Fit operation 168
- Fixed magnification 169
- Fixturing 63, 259
- Flow control steps 45
- Focus 122, 364
- Focus lock 268, 276
- Font 234
- Font size 48
- Footers 232
- Footers for part view printing 326
- Footswitch buttons 327
- Format 48
- Formatting text 234
- Formatting time, date and angles 330
- Form error for a valid pixel calibration 349
- Form error whiskers 169, 304
- FOV spherical and NLEC corrections 347
- Full CNC mode 275, 276

## G

- General parameters 337
- General program setup 259
- Generate new templates 224
- Geometric tolerances 2
- Goto 37
- Goto click 37
- Goto position 37
- Goto selected feature 37, 114
- Goto worm 52
- Goto worm functions 36
- Goto worm stop 52
- Graphics 236, 238
- Graphic displays 12, 275
- Grid lines 231
- Guide features 260, 269

## H

- Halting execution for failure to select features 316
- Hand cursor 32
- Hazards of open-loop motor operation 290
- Headers and footers 232
- Headers and footers for part view printing 326
- Height
- Height probe 85, 95, 135
- Help 22
- Help from your distributor 366
- Help menu 3
- Help tips 305
- Hiding features 269
- Hiding toolbars 53
- Hiding windows 39
- Highest magnification 118, 121
- High accuracy 52
- High accuracy mode 82, 268, 340
- High accuracy scanning 82
- Histogram chart 221
- Horizontal and vertical grid lines 231

## I

- Icons 9, 217
- Icon buttons 55



- Icon size 53
- Identical parts 260
- Identical parts organized into a consistent matrix 262
- Illumination system 363
- Image 255, 274
- Image captures 349
- Image in the live video window 363
- Image processing 363
- Import 23
- Importing features 252
- Importing from a drawing file 160
- Imports 333
- Import file formats 23
- Including probes and points in live video image captures 349
- Initial program settings 265
- Initial setup of the video probe system 116
- Inserting breakpoints to pause program execution 287
- Inserting new program steps 286
- Inside and outside material surfaces 163
- Interaction with the operator 273
- Irregular features 101
- J**
- Joystick 37, 350, 351
- Joystick and footswitch buttons 327
- Joystick functions 37
- Joystick motion control 350
- Joystick setup 290
- Joystick teach wizard 351
- L**
- Landmark features 110
- Language 36
- Larger video window 348
- Last edge position in the DRO 330
- Last part 339
- Left or right justifying label text 48
- Level-based button functions 327
- Leveling the part (optional) 95, 139
- Lighting with magnifications 77
- Light adjustment 77
- Light conditions 260
- Light control 77, 267
- Light control slider values 267
- Limiting maximum axis velocity 290
- Limit switch setup 292
- Lines 147, 238
- Lines constructed from a circle and an arc 182
- Lines constructed from a circle and a slot 183
- Lines constructed from a line and an arc 181
- Lines constructed from a line and a circle 181
- Lines constructed from a line and a slot 181
- Lines constructed from a point and an arc 179
- Lines constructed from a point and a circle 179
- Lines constructed from a point and a line 178
- Lines constructed from two circles 182
- Lines constructed from two lines 180
- Line constructed from a line 178
- Line constructed from a line and an angle 182
- Line constructed from a line and a distance 180
- Line constructed from a point and a slot 179
- Line constructed from a slot 183
- Line constructed from two arcs 183
- Line constructed from two blobs 184
- Line constructed from two points 178
- Line constructed from two slots 183, 184, 190
- Line width 97
- Live video image captures 349
- Live video window 15, 51, 249, 363
- Live video window menus 51
- LMC tolerances 209
- Loading a video chart 115
- Locking part files 319
- Locking programming functions 318
- Locking results window contents 318
- Locking supervisor settings 319
- Locking template functions 318
- Locking the DRO datuming 318
- Locking the run mode in program execution 318
- Locking the status bar contents 318
- Locking user settings 319
- Locking window position and size 318
- Lower magnifications 121
- Low contrast edges 125

**M**

Machine reference frame 260  
Machine zero 331, 338  
Machine zero and general parameters 337  
Magnification 15, 58, 77, 120, 169, 267, 341  
Magnifications with associated zooms 116  
Magnification levels 35  
Magnification value 343  
Maintenance 299  
Maintenance issues 353  
Malfunction 353  
Mapping parts to a toolbar 311  
Mapping workspaces to toolbar 312  
Material surfaces 163  
Matrix 262  
Matrix of identical parts 259  
Matrix of parts 264  
Maximum axis velocity 290  
Maximum field of view for worm probe 346  
Maximum form error for a valid pixel  
    calibration 349  
Maximum number of measurement points 321  
Maximum program executions 317  
Maximum program execution speed 255, 275  
Measure 22  
Measurements finish before I'm ready 365  
Measurement database 11  
Measurement functions 35  
Measurement indications to display 164  
Measurement parameters 320  
Measurement points 321  
Measurement process 138  
Measurement programming method 251  
Measurement reference 139  
Measurement reference frame 35  
Measurement tolerances 162  
Measurement workspace 138  
Measure magic 47, 144, 320  
Measure menu 35  
Measure part features 63  
Measure profile window 157  
Measure profile window color 304  
Measuring 137  
Measuring features 69, 144

Measuring part skew and datum 67  
Menubar menus 22  
Menus 5, 22, 41  
Messages 274  
Message to the user 255  
Metric units 29, 33  
Metronics QC quickie slide 63  
Microsoft Access 3  
Microsoft Excel 3  
Minimum contrast criteria 126  
Minimum number of measurement points 321  
Misalignment 132  
MMC and LMC tolerances 209  
Monitor 16  
Motors off 37  
Mouse hover 10  
Moving video charts with the part 345

**N**

Name 27, 47, 257  
Named tolerances 206  
Names on part views 323  
Narrow or wide window 48  
Nearest 85, 93, 135  
New (File menu) 23  
New magnification 118  
New template 39  
New templates 224  
New VED probe 51, 85, 105  
Normal and fine velocities 352  
Normal speed 290  
Note 27  
Note with a feature 270  
No part fixturing 259  
Number of measurement points 321  
Number of program executions 260

**O**

Offset 129, 331  
Offset calibration 129  
OK (measurement) 52  
Tolerance parameters 206  
On-screen help tips 305  
On-screen menus 41

- Open 23
- Open-loop mode 290
- Opening an existing template 39
- Opening custom workspaces 60
- Opening templates 224
- Opening the last part automatically 339
- Optical magnification 35, 265, 267
- Optimize steps function 254
- Optimizing program steps 254
- Order of columns 231
- Orientation 79
- Other/continuous 52
- Other/high accuracy 52
- Output lines 277
- Outside material surfaces 163
- Overlap 342
- Overlays 84, 335

**P**

- P/V toolbar button 16
- Page setup 24
- Pallet 259
- Palletizing multiple parts 262
- Panning 29
- Parallelism tolerances 213
- Parents of constructed features in a different color 325
- Parents of construction features 283
- Parent feature 284
- Parts 335
- Parts and probe position 322
- Parts organized into a consistent matrix 262
- Part condition 77
- Part features 2
- Part file 63, 335
- Part fixturing 259
- Part following 37
- Part lighting control 267
- Part skew and datum 67
- Part variations 113
- Part view 8, 323
- Part view printing 326
- Part view window 12, 39
- Part view window colors 303

- Part view window menus 50
- Pass/fail icons 205, 218
- Pass/fail indications 217
- Passed 167
- Password 260
- Paste 45
- Paste special 45
- Pasting and deleting program steps 285
- Pattern 135
- Pattern file names 347
- Pattern finder probe 85, 108
- Pattern probe 341
- Pattern search 342
- Pattern search rings 341
- Pause mode 45
- Pause program execution 273, 287
- PC card 1
- Performing automatic backups 336
- Perimeter scans 103
- Permanent part fixturing 247, 259, 314
- Perpendicularity tolerances 213
- Phantom 27
- Phantom features 269
- Phase display 294
- Pixel calibration 349
- Pixel resolution 127
- Placeholder magnification 118
- Play sound 273
- Points 146, 166
- Points constructed from a arc and a line 173
- Points constructed from a circle and a line 176
- Points constructed from a distance 175
- Points constructed from a line 174
- Points constructed from multiple features 177
- Points constructed from two circles 176
- Point constructed from an angle 177
- Point constructed from an arc 177
- Point constructed from a blob 177
- Point constructed from a circle 175
- Point constructed from a distance and a point 175
- Point constructed from a point 173
- Point constructed from a point and a line 173
- Point constructed from a profile 177
- Point constructed from a slot 176
- Point constructed from two lines 174

- Point constructions 173
  - Point feature size 322
  - Point filtration 270
  - Point filtration/filtered 27
  - Point filtration for probed points 257
  - Point measurements 321
  - Polar coordinates 11, 29, 33
  - Position 79
  - Position indicator 32, 266
  - Position tolerances 208
  - Power assist mode 276
  - Pre-selecting features for a construction 321
  - Precisely located features 111
  - Preliminary skew and datum 110
  - Preparing to use video probes 77
  - Prevent program from being modified by anyone
    - but supervisor 260
  - Print 24
  - Printed reports 215, 220, 241
  - Print part view 50
  - Print preview 24
  - Print selection 42, 45
  - Probe 22, 66, 75, 340
  - Probe animation rate 346, 362
  - Probe continuous fire 362
  - Probe data collection parameters 135
  - Probe descriptions 85
  - Probe library 78, 118, 129
  - Probe magnification 58
  - Probe menu 35
  - Probe orientation 79
  - Probe position 11, 79, 322
  - Probe position indicator 265, 266, 268
  - Probe rotation 344
  - Probe selection 265
  - Probe size 80
  - Probe system 116
  - Probe teach values 260
  - Probe toolbar 15, 117
  - Probe type 35, 79
  - Probe type radio button 253
  - Probing 282
  - Probing and measuring features 144
  - Probing a datum zero point 141
  - Probing part features 168
  - Problem solving 353
  - Profile feature 171
  - Profile fit results 165
  - Profile measurements 159
  - Profile tolerance 212
  - Program 3, 18, 63
  - Program's runtime environment 260, 265
  - Programming 36, 247
  - Programming functions 38, 45
  - Programming methods 249
  - Programming parameters 314
  - Programming process 250
  - Programming wizards 3, 45
  - Program complete messages 315
  - Program content 11
  - Program editing 260
  - Program edit menus 44
  - Program evaluation 287
  - Program execution 260, 275, 287
  - Program execution after a pause 287
  - Program image 274
  - Program properties 258
  - Program recording 251, 261, 314
  - Program settings 265
  - Program status 58
  - Program steps 20, 218, 249, 278
  - Program step actions 218
  - Program template 20, 218
  - Program template window 249
  - Prohibiting toolbar docking 311
  - Projected zone 213
  - Prompting 273
  - Prompting the user for alphanumeric information 235
  - Pseudo-sinusoidal 290
- ## Q
- QC5200 program doesn't launch 358
  - QC5200 workspace 303
  - QC quickie slide 63
  - Quantization factor 271
  - Quick start demonstration 63, 75

**R**

Raised edges for toolbar buttons 310  
Randomly measure this percent of guide features 260  
Record 66, 249, 251, 261  
Record/edit mode 45  
Recording the user's measurement activities 251  
Rectangular shapes 239  
Redraw of part view 323  
Reference 139  
Reference frame 12, 35, 260  
Reference frame indicator 33  
Reference marks 296  
Reference mark type 296  
Reference offsets 297, 331  
Remove last 52  
Removing a breakpoint 287  
Removing buttons from a toolbar 310  
Reporting 215  
Reports 3, 73, 215, 222, 241  
Report template 20, 222  
Requiring user interaction to complete a measurement 284  
Resolution 127, 292, 296  
Resolution, time and date 330  
Restricting access to setup screens 318  
Restrict program editing to supervisors 260  
Results 8  
Results data 217  
Results window 17, 39  
Results window colors 303  
Resuming program execution after a pause 287  
Retries on tolerance failures 316  
Right justifying label text 48  
Rings (pattern search) 341  
Ring overlap (pattern search) 342  
Rotation 344  
Rows 229  
RS-232 port 338  
Run-time environment 260, 265  
Run-time parameters 286  
Run-time parameter conflicts 286  
Running the program 74  
Runout tolerances 210

Runs charts 220  
Runs database 219  
Runs template 71, 219  
Run field 28  
Run program this many times 260  
Run time graphic displays 275  
R bar chart 221

**S**

Save 23  
Save as 23  
Save template as 43  
Saving custom workspaces 60  
Saving part files automatically 336  
Saving templates 39  
Saving the part 74, 261  
Saving user access 337  
Scaling video charts to magnification 341  
Scans beyond the field of view 104  
Scan direction 80, 102  
Scan lines 78  
Screen space 16  
Scrollbars 19  
Search criteria 26  
Search rings (pattern search) 341  
Search ring overlap (pattern search) 342  
Selecting all steps 279  
Selecting and teaching the probe 66  
Selecting a probe type 79  
Selecting groups of steps 278  
Selecting individual steps 278  
Selecting program steps 278  
Selecting templates 65  
Selection zones size 322  
Select all 42, 45, 50  
Select all similar steps 45, 280  
Select none 45  
Sending coefficient data to the serial port 337  
Separating templates 18  
Sequences of measurement steps 247  
Serial port 337  
Serial port, machine zero and general parameters 337  
Settings or appearance have changed 355

- Setting machine zero 338
- Setting serial port, machine zero and general parameters 337
- Setting the display of resolution, time and date 330
- Setting up programming parameters 314
- Setting up the video probes 340
- Setup 299
- Setup of the video probe system 116
- Setup parameters 36
- Sharing axes 350
- Showing a note with a feature 270
- Showing full file names 336
- Showing headers and footers 232
- Showing parents of constructed features in a different color 325
- Showing the feature name 270
- Showing the last edge position in the DRO 330
- Showing the measurement reference frame 29
- Showing the probe position 29
- Show position indicator 32
- Show reference frame indicator 33
- Sigma 271
- Sigma factor 271
- Similar steps 280
- Simple data chart 221
- Simple probe 78, 85, 87, 105, 135
- Simple zeroing of the DRO axis positions 339
- Single-stepping program execution 288
- Single monitor 16
- Size 80
- Size of text 234
- Skew 63, 132
- Skew alignment 140
- Skew and datum 67, 110, 251
- Skew compensation 132
- Slots 151
- Soft edge 125
- Sorting data 230
- Sound 255, 273
- Sounds during program execution 315
- Special program steps 272
- Special steps 45, 255
- Specifying automatic redraw of part view 323
- Specifying a deadband 351
- Specifying a filtration error limit 271
- Specifying a filtration standard deviation range 271
- Specifying encoder count direction 331
- Specifying encoder parameters 331
- Specifying encoder reference marks 331
- Specifying encoder resolution 331
- Specifying encoder unit of measure 331
- Specifying feature display defaults 320
- Specifying feature selection zones size 322
- Specifying file names, locations and backups 332
- Specifying measurement indications to display 164
- Specifying normal and fine velocities 352
- Specifying the axis motion profile 352
- Specifying the headers and footers for part view printing 326
- Specifying the maximum number of measurement points 321
- Specifying the maximum program executions 317
- Specifying the minimum number of measurement points 321
- Specifying the point feature size 322
- Speech output 236
- Square and rectangular shapes 239
- Stacking and separating templates 18
- Standard deviation range 271
- Starting measure magic automatically 320
- Starting program recording 251
- Starting program recording automatically 314
- Startup message 300
- Statusbar 5, 58
- Statusbar definition 10
- Status bar information 308
- Status data 10
- Steps 278
- Step selections 281
- Stop sign 103
- Straightness tolerance 211
- Strongest contrast edge 125
- Style and size of text 234
- Supervisor setup 38, 299
- Supervisor setup parameters 36
- Super steps 282
- System and part condition 77

System error messages 306  
System interaction with the operator 273  
System overview 1  
System resources 275  
System seems slow 362

## T

Target position for probing 282  
Teach 124, 126  
Teaching the pattern 108  
Teaching the video probe 66  
Teach mode 340  
Teach VED edge 51  
Temperature compensation status 58  
Template 39  
Templates 3, 8, 65, 215, 335  
Template contains unwanted data or  
    formatting 360  
Template content 19  
Template edit menus 41  
Template files 335  
Template file operations 43  
Template state 265, 266  
Template windows 18  
Template window menus 41  
Temporary fixturing 63, 247  
Temporary part fixturing 259  
Text 234  
Text entry 235  
Text font size 48  
Text to speech output 236  
Time and date 330  
Time delay 255  
Title bar 56  
Tolerance 63, 165  
Tolerances 2, 70, 201  
Tolerance bonus 209  
Tolerance failures 316  
Tolerance measurements 18, 36  
Tolerance measurement results 11  
Tolerance menu 203  
Tolerance menu item 36, 48  
Tolerance name 206  
Tolerance parameters 48, 206

Tolerance pass/fail indications 217  
Tolerance report 63  
Tolerance results 205, 223  
Tolerance templates 21, 223  
Tolerance toolbar 203  
Tolerance type 204, 207  
Tolerance type icons 217, 218  
Tolerancing 201  
Tolrep 21, 223  
Toolbars 5, 9, 12, 55, 309  
Toolbar buttons 309  
Toolbar docking 311  
Toolbar icon size 53  
Toolbar shape 56  
Toolbar title 54  
Tools 22  
Tool tips 55  
Tracking user activity 339  
Troubleshooting 353  
True position tolerances 208  
TTL encoders 289  
Type field 28

## U

Undocking toolbars 56  
Unequal tolerances 162  
Unfiltering (restoring) filtered data points 170  
Unilateral tolerance 212  
Units 33  
Units of measure 10, 29, 58, 268, 296  
Unstack templates 18  
Unwanted data or formatting 360  
User-defined magnification 169  
User access to settings 337  
User activity 339  
User interaction to complete a measurement 284  
User interface 5, 7  
User messages 274  
Use machine reference frame 260  
Use probe teach values as recorded 260  
Using video probes 77

## V

- Variations 113
- VED probes 51
- VED toolbar 79
- Vertical grid lines 231
- Video camera 15
- Video camera image type 346
- Video chart 84, 135, 341, 345
- Video chart rotation 345
- Video edge detection 75
- Video edge recognition (teach) 124
- Video image captures 349
- Video image processing 363
- Video magnification 77
- Video probes 66, 340, 364
- Video probe animation rate 346
- Video probe data collection parameters 135
- Video probe descriptions 85
- Video probe system 1161
- Video window 51, 348
- Video window menus 51
- Viewing calibration values 351
- Viewing current position values 350
- View menu 22, 29

## W

- Wait for point steps 283
- Wave display 293
- Wide format 338
- Wide window 48
- Width 85, 97, 135
- Width tolerances 214
- Windows 5, 8, 11, 22, 39
- Windows presented separately 18
- Windows tabbed and stacked 18
- Window is missing from the screen 355
- Workspaces 5, 34, 65, 335
- Workspace background color 303
- Workspace files 335
- Worm 85, 135
- Worm probe 102, 107, 346
- Wrong direction 356

## X

- X-Y reference frame 33
- X bar chart 221

## Z

- Zeroing of the DRO axis positions 339
- Zero point 141
- Zones size 322
- Zoom 29, 116
- Zooming to view whole part on constructions 323
- Zooming to view whole part on measurements 323
- Zoom all 29, 50
- Zoom functions 50
- Zoom out 31
- Zoom positions 119
- Zoom special 30, 50
- Zoom window 50